

MC31XX Series Mobile Computer Integrator Guide

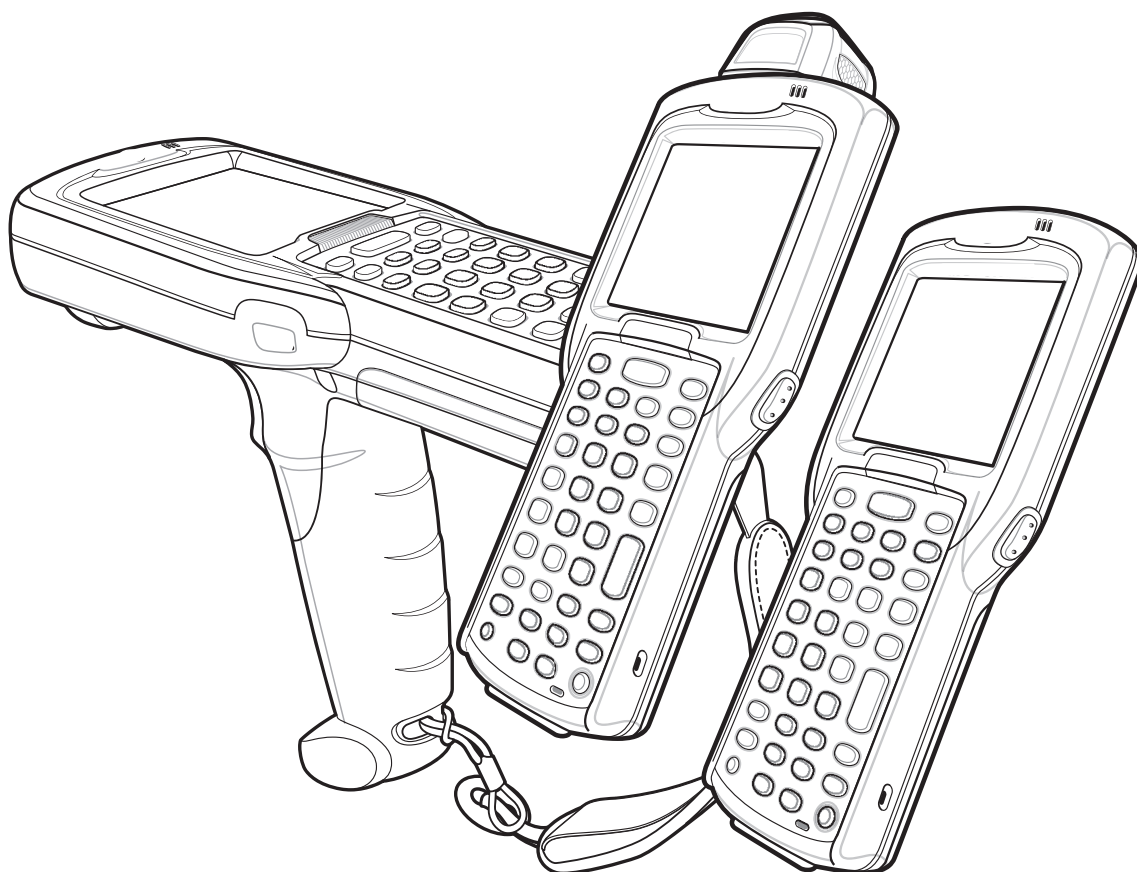

MC31XX Series Mobile Computer

Integrator Guide

72E-124292-03

Revision B

March 2015

© 2015 Symbol Technologies, Inc.

No part of this publication may be reproduced or used in any form, or by any electrical or mechanical means, without permission in writing from Zebra. This includes electronic or mechanical means, such as photocopying, recording, or information storage and retrieval systems. The material in this manual is subject to change without notice.

The software is provided strictly on an “as is” basis. All software, including firmware, furnished to the user is on a licensed basis. Zebra grants to the user a non-transferable and non-exclusive license to use each software or firmware program delivered hereunder (licensed program). Except as noted below, such license may not be assigned, sublicensed, or otherwise transferred by the user without prior written consent of Zebra. No right to copy a licensed program in whole or in part is granted, except as permitted under copyright law. The user shall not modify, merge, or incorporate any form or portion of a licensed program with other program material, create a derivative work from a licensed program, or use a licensed program in a network without written permission from Zebra. The user agrees to maintain Zebra’s copyright notice on the licensed programs delivered hereunder, and to include the same on any authorized copies it makes, in whole or in part. The user agrees not to decompile, disassemble, decode, or reverse engineer any licensed program delivered to the user or any portion thereof.

Zebra reserves the right to make changes to any software or product to improve reliability, function, or design.

Zebra does not assume any product liability arising out of, or in connection with, the application or use of any product, circuit, or application described herein.

No license is granted, either expressly or by implication, estoppel, or otherwise under any Zebra Technologies Corporation, intellectual property rights. An implied license only exists for equipment, circuits, and subsystems contained in Zebra products.

Zebra and the Zebra head graphic are registered trademarks of ZIH Corp. The Symbol logo is a registered trademark of Symbol Technologies, Inc., a Zebra Technologies company.

Zebra Technologies Corporation
Lincolnshire, IL U.S.A.
<http://www.zebra.com>

Table of Contents

Revision History	iii
------------------------	-----

About This Guide

Introduction	xi
Documentation Set	xi
Configurations	xii
Software Versions	xii
Chapter Descriptions	xiv
Notational Conventions	xv
Related Documents and Software	xv
Service Information	xvi

Chapter 1: Getting Started

Introduction	1-1
Unpacking the Mobile Computer	1-1
Features	1-1
Rotating Scan Turret	1-3
Mobile Computer Startup	1-6
Install SD Card	1-6
Install Main Battery	1-7
Battery Charging	1-8
Spare Battery Charging	1-9
Stylus	1-10
Starting the Mobile Computer	1-10
Calibration Screen	1-10
Resetting the Mobile Computer	1-11
Windows CE Devices	1-11
Windows Mobile 6.1 Devices	1-12
Waking the Mobile Computer	1-13
Main Battery Removal	1-15
Handstrap Removal and Replacement (MC31XXS/R)	1-18
Handstrap Removal and Replacement (MC3190G)	1-18

Chapter 2: Accessories

Introduction	2-1
Single Slot Serial/USB Cradle	2-4
Setup	2-5
Battery Charging	2-5
LED Charge Indications	2-6
Communication Setup	2-7
Four Slot Charge Only Cradle	2-8
Setup	2-8
Battery Charging	2-8
Power LED	2-9
LED Charge Indications	2-9
Four Slot Ethernet Cradle	2-10
Setup	2-10
Ethernet Cradle Drivers (Windows CE 6.0)	2-10
Ethernet Cradle Drivers (Windows Mobile 6.1)	2-11
Charging and Communication	2-12
LED Charge Indications	2-13
Speed LED	2-13
Link LED	2-13
Daisy chaining Ethernet Cradles	2-13
Wall Mount Bracket	2-14
Four Slot Spare Battery Charger	2-17
Setup	2-17
Spare Battery Charging	2-17
LED Charge Indications	2-18
Cables	2-19
Setup	2-20
Battery Charging	2-20
LED Charge Indications	2-20
Communication Setup	2-20
Universal Battery Charger (UBC) Adapter	2-21
Setup	2-21
Spare Battery Charging	2-21
UBC Adapter LED Charge Indications	2-22
Serial/USB Communication	2-24
Installing Serial/USB Communication Software	2-24

Chapter 3: ActiveSync

Introduction	3-1
Installing ActiveSync	3-1
Mobile Computer Setup	3-2
Setting Up an ActiveSync Connection on the Host Computer	3-3
Setting up a Partnership with a Windows CE 6.0 Device	3-4
Synchronization with a Windows Mobile 6.1 Device	3-6

Chapter 4: Application Deployment for Windows CE

Introduction	4-1
--------------------	-----

Application Design Considerations	4-1
Packaging	4-1
Software Installation on Development PC	4-1
Platform SDK	4-2
EMDK for C	4-2
Installing Other Development Software	4-3
Software Updates	4-3
Windows CE Flash Storage	4-4
FFS Partitions	4-4
Working with FFS Partitions	4-4
RegMerge.dll	4-4
CopyFiles	4-5
Non-FFS Partitions	4-5
Downloading Partitions to the Mobile Computer	4-6
Bootloader	4-6
Deployment	4-6
Copying Files from a Host Computer	4-7
Adding Programs	4-8
Updating Images	4-9
Mobility Services Platform	4-16
Creating a Splash Screen	4-17

Chapter 5: Application Deployment for Windows Mobile

Introduction	5-1
Application Design Considerations	5-1
Security	5-1
Application Security	5-1
Digital Signatures	5-1
Device Management Security	5-3
Remote API Security	5-3
XML Provisioning	5-4
Creating an XML Provisioning File	5-4
XML Provisioning vs. RegMerge and Copy File	5-4
Packaging	5-6
Software Installation on Development PC	5-6
EMDK for C	5-7
Installing Other Development Software	5-7
Software Updates	5-7
Windows Mobile File Storage	5-7
Random Access Memory	5-7
Persistent Storage	5-8
Application Folder	5-8
Deployment	5-8
Copying Files from a Host Computer	5-9
Adding Programs	5-10
Updating Images	5-11
Mobility Services Platform	5-12
Creating a Splash Screen	5-12

Chapter 6: Wireless Applications

Introduction	6-1
Signal Strength Icon	6-2
Turning Off the Radio	6-3
On Device with Windows CE 6.0	6-3
On Device with Windows Mobile 6.1	6-3

Chapter 7: Interactive Sensor Technology Configuration

Introduction	7-1
IST Menu	7-1
General Tab	7-2
Power Management Tab	7-3
Display Tab	7-4
Event Log Tab	7-4

Chapter 8: Maintenance & Troubleshooting

Introduction	8-1
Maintaining the Mobile Computer	8-1
Battery Safety Guidelines	8-1
Storage	8-2
Cleaning	8-3
Materials Required	8-3
Cleaning the MC31XX	8-3
Cleaning Cradle Connectors	8-4
Cleaning Frequency	8-4
Troubleshooting	8-5
Mobile Computer	8-5
Single Slot Serial/USB Cradle	8-7
Four Slot Charge Only Cradle	8-7
Four Slot Ethernet Cradle	8-8
Four Slot Spare Battery Charger	8-9
UBC Adapter	8-9
Cables	8-10

Appendix A: Technical Specifications

Mobile Computer and Accessory Technical Specifications	A-1
Mobile Computer Pin-Outs	A-6

Appendix B: Special Software Configurations

Battery Usage Threshold Setting	B-1
Registry Setting	B-1
Bluetooth Configuration Setting	B-2
Sample Applications and StartUpCtl Configuration	B-3
StartUpCtl Application Configuration	B-3
Removing Sample Applications and StartUpCtl Application	B-3

Appendix C: Windows Mobile 6.5

Introduction	C-1
Finger Scrolling	C-1
Home Screen	C-1
Classic Today Screen	C-3
Status Bar	C-4
Tile Bar	C-6
Start Screen	C-6
Speaker Icon	C-9
Battery Icons	C-9
Connectivity Icon	C-10
Clock Icon	C-10
Locking the MC3100	C-10
Microsoft Locking	C-10
Password Locking	C-11
Using the RS507 Hands-free Imager	C-13
Removing the Battery	C-13
Battery Removal	C-13
Suspend Mode	C-13
USB Configuration	C-14

Glossary**Index**

About This Guide

Introduction

This guide provides information about setting up and configuring MC31XX mobile computers and accessories.



NOTE Screens and windows pictured in this guide are samples and may differ from actual screens.

For configurations with OEM version 02.27.0000 and Windows Mobile 6.5 operating system, Refer to [Appendix C, Windows Mobile 6.5](#) for information about new features.

Documentation Set

The documentation set for the MC31XX is divided into guides that provide information for specific user needs.

- **MC31XX Series Quick Start Guide** - describes how to use the MC31XXS and MC31XXR mobile computers.
- **MC3190G Quick Start Guide** - describes how to use the MC3190G mobile computer.
- **MC31XX Series Mobile Computer User Guide** - describes how to use the MC31XX mobile computer.
- **MC31XX Series Mobile Computer Integrator Guide** - describes how to set up the MC31XX mobile computer and the accessories.
- **Microsoft Applications for Windows Mobile 6.1 and CE 6.0 User Guide** - describes how to use Microsoft developed applications.
- **Application Guide for Zebra Devices** - describes how to use Zebra developed applications.
- **EMDK Help File** - provides API information for writing applications.

Configurations

This guide covers the following configurations:

Configuration	Radios	Display	Memory	Data Capture	Operating System	Keypads
MC3100R	WPAN: Bluetooth	Color	128 MB RAM/ 256 MB Flash or 256 MB RAM/512 MB Flash	1D laser scanner in rotating turret	Windows CE 6.0 Professional	28, 38 or 48 key
MC3100S	WPAN: Bluetooth	Color	128 MB RAM/ 256 MB Flash or 256 MB RAM/512 MB Flash	1D laser scanner in rotating turret	Windows CE 6.0 Professional	28, 38 or 48 key
MC3190G	WLAN: 802.11a/b/g WPAN: Bluetooth	Color	128 MB RAM/ 512 MB Flash or 256 MB RAM/1 GB Flash	1D laser scanner or 2D imager	Windows CE 6.0 Professional or Windows Mobile 6.X Classic	28, 38 or 48 key
MC3190S	WLAN: 802.11a/b/g WPAN: Bluetooth	Color	128 MB RAM/ 512 MB Flash or 256 MB RAM/1 GB Flash	1D laser scanner, 2D imager or DPM Imager	Windows CE 6.0 Professional or Windows Mobile 6.X Classic	28, 38, 48 key
MC3190R	WLAN: 802.11a/b/g WPAN: Bluetooth	Color	128 MB RAM/ 512 MB Flash or 256 MB RAM/1 GB Flash	1D laser scanner in rotating turret	Windows CE 6.0 Professional or Windows Mobile 6.X Classic	28, 38, 48 key

Software Versions

This guide covers various software configurations and references are made to operating system or software versions for:

- Adaptation Kit Update (AKU) version
- OEM version
- BTE Explorer version
- Fusion version.

AKU Version for Windows Mobile 6.X Devices

To determine the Adaptation Kit Update (AKU) version on a Windows Mobile 6.X device:

Tap **Start** > **Settings** > **System** tab > **About** icon > **Version** tab.

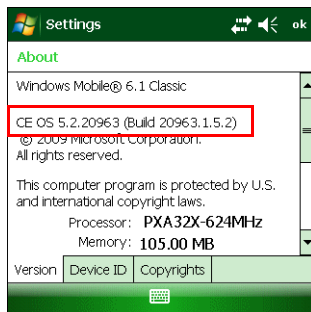

The second line lists the operating system version and the build number. The last part of the build number represents the AKU number. For example, *Build 20963.1.5.2* indicates that the device is running AKU version 1.5.2.

OEM Version on Windows Mobile 6.X Devices

To determine the OEM software version on a Windows Mobile 6.X device:

Tap **Start** > **Settings** > **System** tab > **System Information** icon > **System** tab.

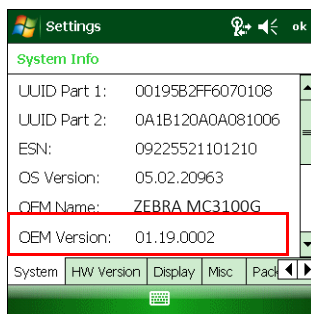

OEM Software on Windows CE 6.0 Devices

To determine the OEM software version on a Windows CE 6.0 device:

Tap **Start** > **Settings** > **Control Panel** > **System Information** icon > **System** tab.

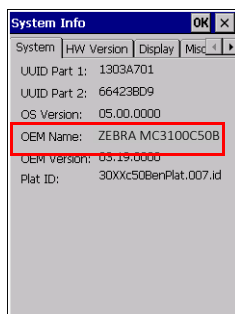

BTE Explorer Software

To determine the BTE Explorer software version on a Windows Mobile 6.X or Windows CE 6.0 device:

Tap **BTE Explorer** icon > **Show BTE Explorer**> **File** > **About**.



Fusion Software

To determine the Fusion software version on a Windows Mobile 6.X or Windows CE 6.0 device:

Tap **Wireless Strength** icon > **Wireless Status** > **Versions**.

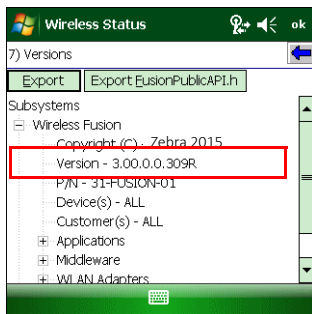

Chapter Descriptions

Topics covered in this guide are as follows:

- [Chapter 1, Getting Started](#), describes the mobile computer's physical characteristics, how to install and charge the batteries, remove and replace the Strap/Door Assembly and how to start the mobile computer for the first time.
- [Chapter 2, Accessories](#), describes the accessories available including cradles, cables and spare battery chargers. Accessory set up and use is also provided.
- [Chapter 3, ActiveSync](#), provides instructions on installing ActiveSync, setting up a partnership and synchronizing information between the mobile computer and a host computer.
- [Chapter 4, Application Deployment for Windows CE](#), provides instructions for provisioning and deploying applications on the MC31XX with WinCE 6.0.
- [Chapter 5, Application Deployment for Windows Mobile](#), provides instructions for provisioning and deploying applications on the MC31XX with Windows Mobile 6.1.
- [Chapter 6, Wireless Applications](#), describes how to configure the wireless connection and how the wireless LANs allow the mobile computers to communicate wirelessly with a host device.
- [Chapter 6, Wireless Applications](#), explains how to configure the wireless LAN connection.
- [Chapter 7, Interactive Sensor Technology Configuration](#), explains how to configure interactive sensing technology on the MC31XX.

- [Chapter 8, Maintenance & Troubleshooting](#), includes instructions on cleaning and storing the mobile computer, and provides troubleshooting solutions for potential problems during mobile computer operation.
- [Appendix A, Technical Specifications](#), includes a table listing the technical specifications for the mobile computer.
- [Appendix B, Special Software Configurations](#), provides instructions for configuring battery usage threshold and Bluetooth and sample applications on Windows CE.
- [Appendix C, Windows Mobile 6.5](#), explains the new features in Windows 6.5.3.

Notational Conventions

The following conventions are used in this document:

- The term “mobile computer” refers to the series of Zebra MC31XX.
- *Italics* are used to highlight the following:
 - Chapters and sections in this and related documents
 - Dialog box, window and screen names
 - Drop-down list and list box names
 - Check box and radio button names
 - Icons on a screen.
- **Bold** text is used to highlight the following:
 - Key names on a keypad
 - Button names on a screen.
- Bullets (•) indicate:
 - Action items
 - Lists of alternatives
 - Lists of required steps that are not necessarily sequential.
- Sequential lists (e.g., those that describe step-by-step procedures) appear as numbered lists.

Related Documents and Software

The following documents provide more information about the MC31XX mobile computers.

- *MC3100 Series Quick Start Guide* p/n 72-124259-xx
- *MC3190G Quick Start Guide*, p/n 72-124276-xx
- *MC3100 Regulatory Guide*, p/n 72- 114046-xx
- *MC3100 User Guide*, p/n 72E-124289-xx
- *Application Guide for Zebra Devices*, p/n 72-68901-xx
- *Microsoft® Applications for Mobile and WinCE 6.0 User Guide*, p/n 72E-78456-xx
- *Microsoft® Applications for Mobile 6 User Guide*, p/n 72E-108299-xx
- *Windows CE Platform SDK for MC3100c50*, available at: <http://www.zebra.com/support>

- *Developer Kit for C (SMDK for C)*, available at: <http://www.zebra.com/support>
- ActiveSync software, available at: <http://www.microsoft.com>.

For the latest version of this guide and all guides, go to: <http://www.zebra.com/support>.

Service Information

If you have a problem with your equipment, contact Zebra support for your region. Contact information is available at: <http://www.zebra.com/support>.

When contacting support, please have the following information available:

- Serial number of the unit
- Model number or product name
- Software type and version number

Zebra responds to calls by email, telephone or fax within the time limits set forth in support agreements.

If your problem cannot be solved by Zebra Support, you may need to return your equipment for servicing and will be given specific directions. Zebra is not responsible for any damages incurred during shipment if the approved shipping container is not used. Shipping the units improperly can possibly void the warranty.

If you purchased your business product from a Zebra business partner, contact that business partner for support.

Chapter 1 Getting Started

Introduction

This chapter describes the mobile computer's physical characteristics, how to install and charge the batteries, how to remove and replace the handstrap and how to start the mobile computer for the first time.

Unpacking the Mobile Computer

Carefully remove all protective material from around the mobile computer and save the shipping container for later storage and shipping. Verify that the equipment listed below is included:

- Mobile computer
- Battery
- Regulatory Guide
- Quick Start Guide.

Inspect the equipment for damage. If any equipment is missing or damaged, contact Zebra Support immediately. See [page xvi](#) for contact information.

Features

There are three versions of the MC31XX mobile computers, the MC31XXS with 1D laser and 2D Imager, the MC31XXR with Rotating Scan Turret and the MC3190G with 1D laser and 2D Imager. For more information on the Rotating Scan Turret, see [Figure 1-3 on page 1-3](#).

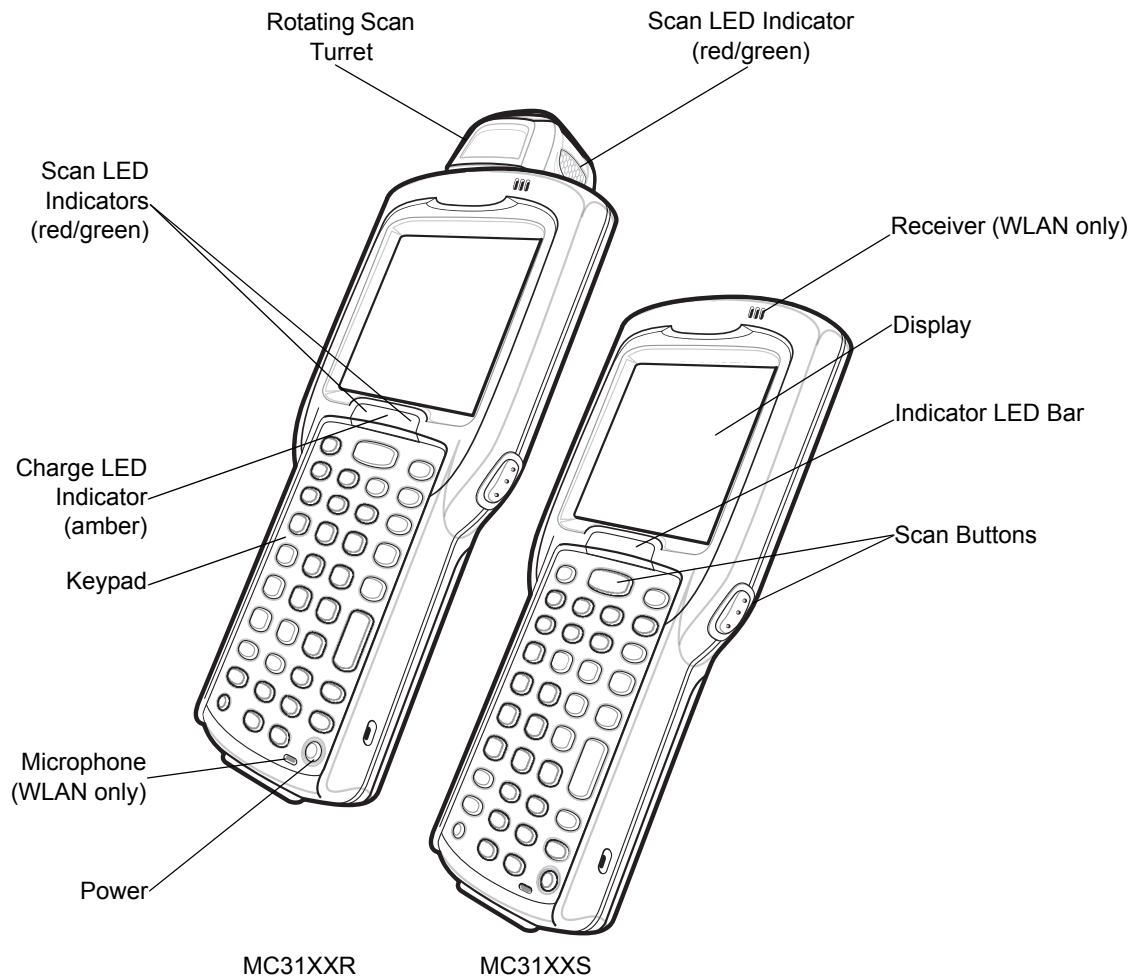

Figure 1-1 MC31XXS and MC31XXR Mobile Computers (Front View)

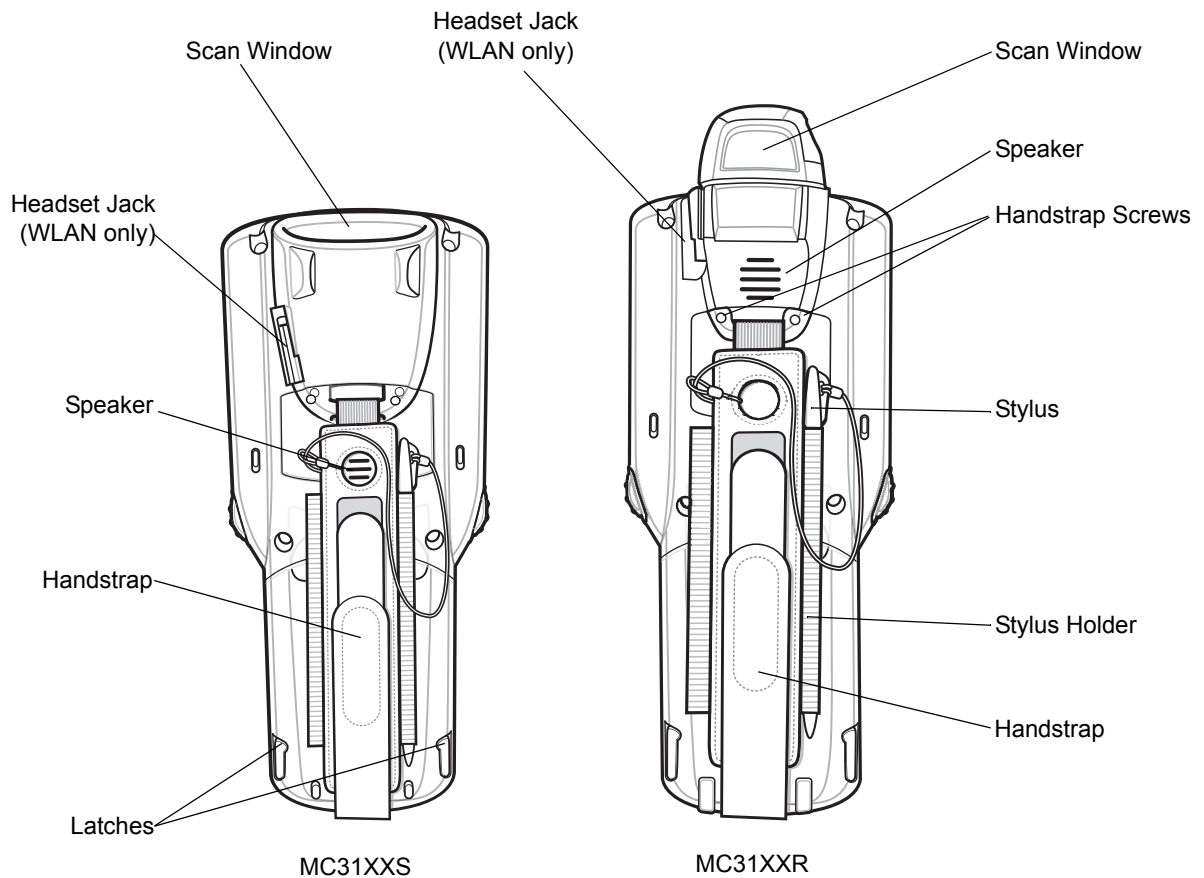

Figure 1-2 MC31XXS and MC31XXR Mobile Computers (Back View)

Rotating Scan Turret

The MC31XXR mobile computer features a Rotating Scan Turret with three position stops. This feature offers greater scanning flexibility.



CAUTION Do not try to rotate turret past side position stops. Damage to device can occur.

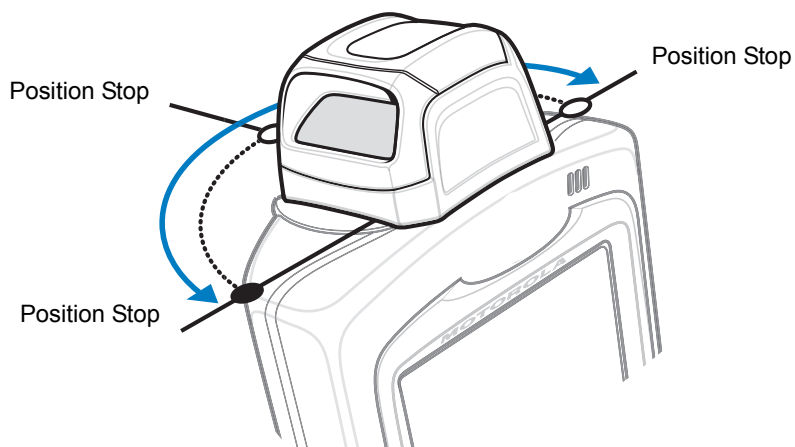

Figure 1-3 Rotating Scan Turret

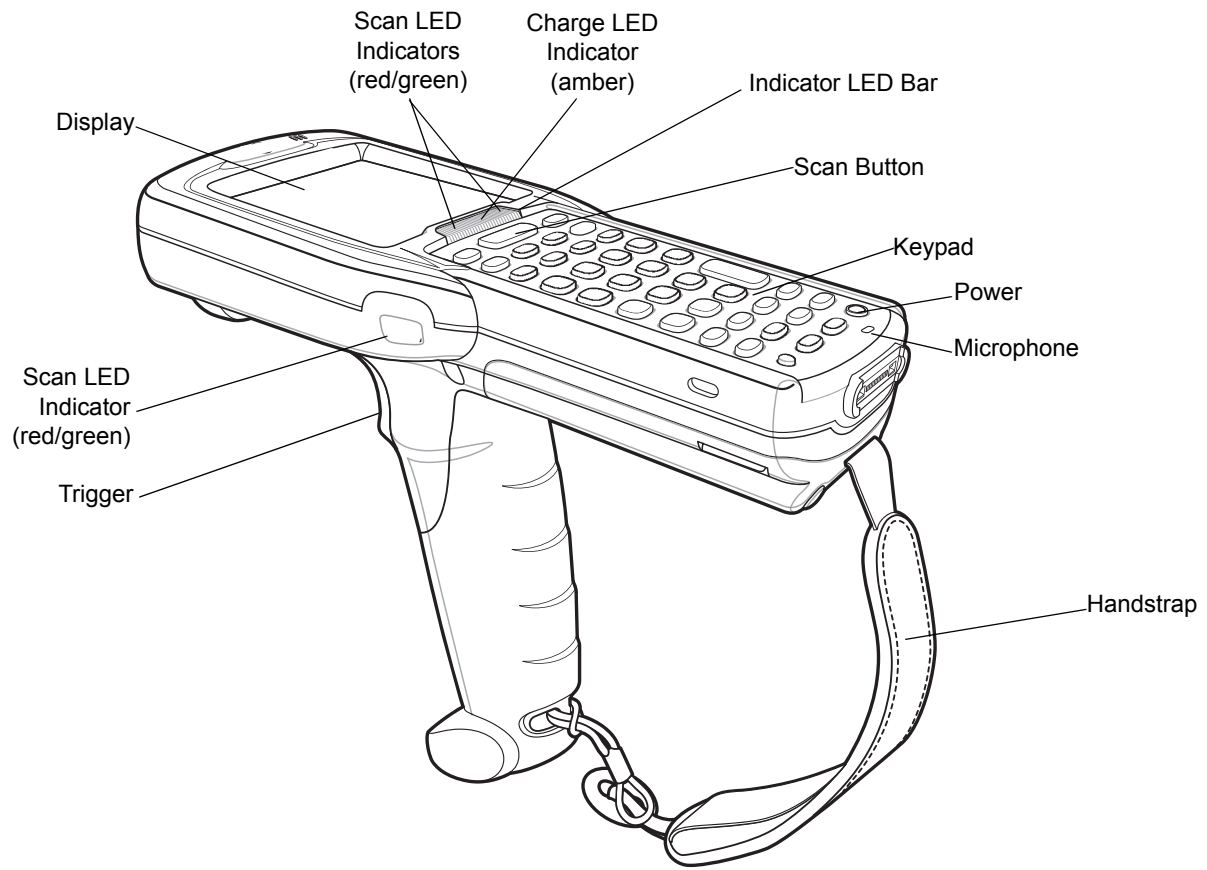

Figure 1-4 MC3190G Mobile Computer (Front View)

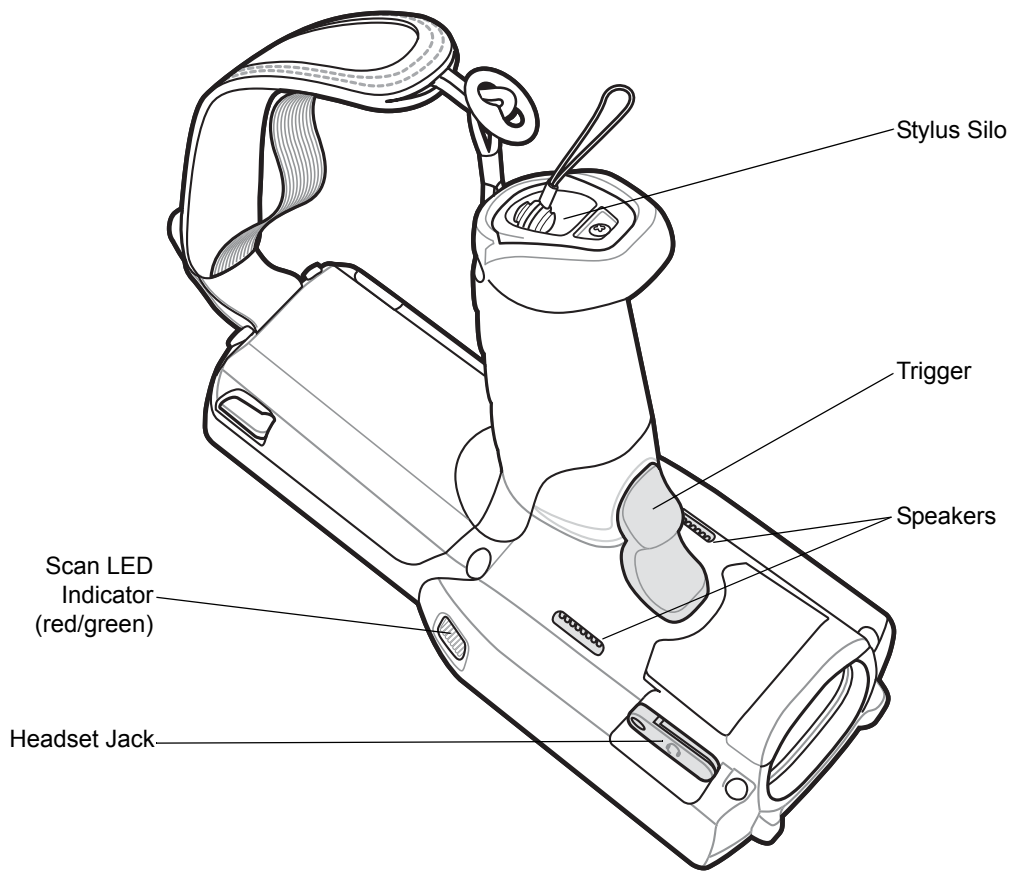

Figure 1-5 MC3190G Mobile Computer (Back View)

Mobile Computer Startup

To start using the mobile computer:

- Install the SD card.
- Install the main battery.
- Charge the main battery and the backup battery.
- Start the mobile computer.

Install SD Card

The Secure Device (SD) card provides secondary non-volatile storage (the flash memory is slower than RAM). The SD card holder is located under the battery.



CAUTION Follow proper Electro-Static Discharge (ESD) precautions to avoid damaging the SD card. Proper ESD precautions include, but are not limited to, working on an ESD mat and ensuring that the operator is properly grounded.

Do not use the SD card slot for any other accessories.



NOTE Select SD cards with environmental and/or the write cycle performance specifications that meet or exceed the application requirements.

To insert the SD card:

1. Lift the SD card retaining door.
2. Position the SD card, with the contacts down, into the SD card slot. The SD card corner notch fits into the slot only one way.
3. Close SD card retaining door.

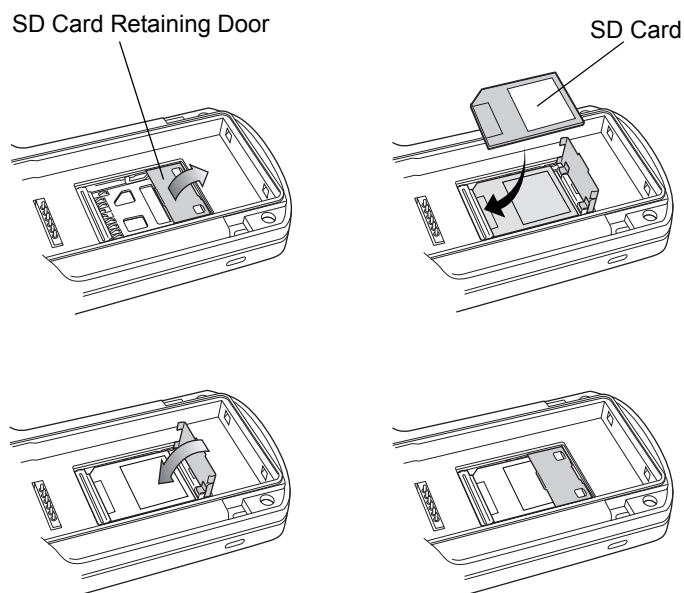

Figure 1-6 *Inserting the SD Card*

Install Main Battery

If the main battery is charged, the mobile computer can be used immediately. If the main battery is not charged, see [Battery Charging on page 1-8](#). To remove the main battery, see [Main Battery Removal on page 1-15](#).

To install the main battery:

1. Remove the battery door.
2. Insert the battery into the slot, bottom first and press the battery gently into the slot. The battery clip locks the battery into place.

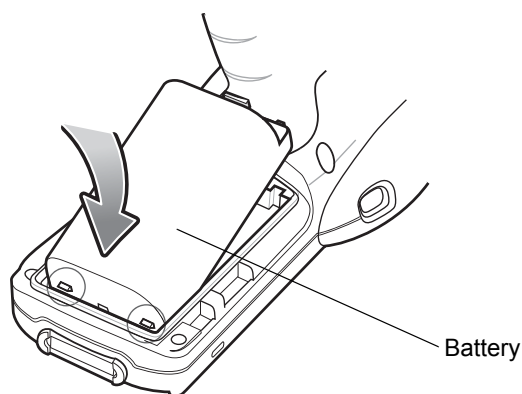

Figure 1-7 *Insert Battery*

3. With the latches in the open position, replace the battery door, top first and press to close.

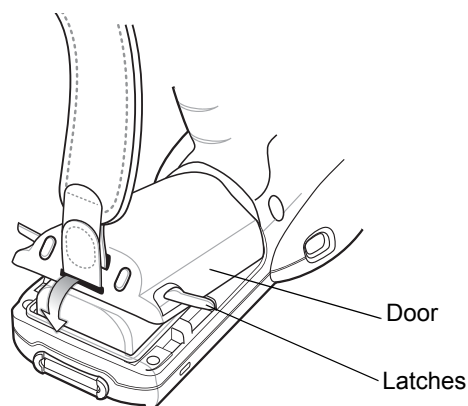

Figure 1-8 *Insert Battery Door*

4. Rotate the latches (to the lock position) to lock the door in place.

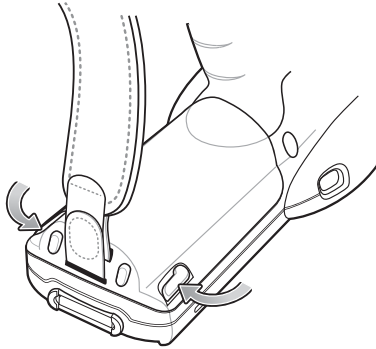

Figure 1-9 Close Latches

Battery Charging



CAUTION Ensure that you follow the guidelines for battery safety described in [Battery Safety Guidelines on page 8-1](#).

Use the mobile computer cradles, cables and spare battery chargers to charge the mobile computer main battery.

The main battery can be charged before insertion into the mobile computer or after it is installed. There are two main batteries for the MC31XX, the Standard Battery (1X) and the Extended Life Battery (2X). The standard capacity battery ships from the factory in all MC31X0-R configurations. The Extended Life Battery ships from the factory in all MC31X0-S and MC31X0-G configurations. To install an Extended Life Battery in the MC31X0-R configurations, purchase an Extended Life Battery and a Brick Extended Life Battery door. Use one of the spare battery chargers to charge the main battery (out of the mobile computer) or one of the cradles to charge the main battery while it is installed in the mobile computer.

Before using the mobile computer for the first time, fully charge the main battery until the amber Charge LED Indicator remains lit (see [Table 1-1 on page 1-9](#) for charge status indications). The Standard Battery fully charges in less than five hours and the Extended Life Battery fully charges in less than eight hours.

The mobile computer is equipped with a memory backup battery which automatically charges from the main battery whether or not the mobile computer is operating or is in suspend mode. The memory backup battery retains data in memory for at least 30 minutes when the mobile computer's main battery is removed or fully discharged. When the mobile computer is used for the first time or after the memory backup battery has fully discharged, the memory backup battery requires approximately 15 hours to fully charge. Do not remove the main battery from the mobile computer for 15 hours to ensure that the memory backup battery fully charges. If the main battery is removed from the mobile computer or the main battery is fully discharged, the memory backup battery completely discharges in several hours.

When the main battery reaches a very low battery state, the combination of main battery and backup battery retains data in memory for at least 72 hours.



NOTE Do not remove the main battery within the first 15 hours of use. If the main battery is removed before the backup battery is fully charged, data may be lost.

Batteries must be charged within the 0° to +40° C (32° to 104° F) ambient temperature range.

The following accessories can be used to charge the batteries:

- Cradles (and a power supply):
 - Single Slot Serial/USB Cradle
 - Four Slot Cradles.
- Cables (and a power supply):
 - USB Client Charge Cable.
- Spare Battery Chargers (and a power supply):
 - Single Slot Serial/USB Cradle
 - Four Slot Spare Battery Charger
 - Universal Battery Charger (UBC) Adapter.

To charge the mobile computer using the cradles:

1. Insert the mobile computer into a cradle. See [Chapter 2, Accessories](#) for accessory information.
2. The mobile computer starts to charge automatically. The amber Charge LED Indicator indicates the charge status. See [Table 1-1 on page 1-9](#) for charging indications.

To charge the mobile computer using the cables:

1. Connect the MC3100 Communication/Charge Cable to the appropriate power source and connect to the mobile computer. See [Chapter 2, Accessories](#) for accessory setup.
2. The mobile computer starts to charge automatically. The amber Charge LED Indicator indicates the charge status. See [Table 1-1 on page 1-9](#) for charging indications.

Table 1-1 Mobile Computer LED Charge Indicators

LED	Indication
Off	Mobile computer not placed correctly in the cradle; cable not connected correctly; charger is not powered.
Fast Blinking Amber	Error in charging; check placement of the mobile computer.
Slow Blinking Amber	Mobile computer is charging.
Solid Amber	Charging complete. Note: When the battery is initially inserted in the mobile computer, the amber LED flashes once if the battery power is low or the battery is not fully inserted.

Spare Battery Charging

There are three accessories that can be used to charge a spare battery:

- Single Slot Serial/USB Cradle
- Four Slot Spare Battery Charger
- UBC Adapter.

To charge a spare battery:

1. Connect the charging accessory to the appropriate power source. See [Chapter 2, Accessories](#) for setup instructions.

2. Insert the spare battery into the spare battery charging slot and gently press down on the battery to ensure proper contact.

The battery starts to charge automatically. The charge LED Indicator lights to indicate the charge status. See [Chapter 2, Accessories](#) for charging indications. The Standard Battery usually fully charges in less than five hours and the Extended Life Battery usually fully charges in less than eight hours.

Stylus

Use the stylus to select items and enter information on the screen. The stylus functions as a pen and a mouse. Tap the touch screen once with the stylus to select options and open menu items.

To remove the stylus, slide the stylus out of the stylus holder. To store the stylus, push the stylus back into the stylus holder in the handstrap (MC31XXR/S) or stylus silo (MC3190G).

Starting the Mobile Computer

When the mobile computer is powered on for the first time, it initializes. The splash screen appears for a short period of time, followed by the **Calibration** screen.

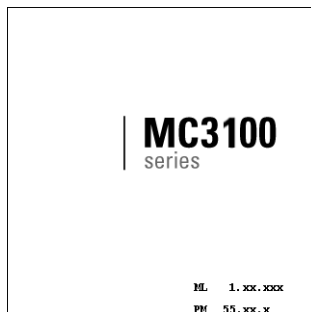

Figure 1-10 *Splash Screen*

On Windows CE 6.0 configurations, after the calibration procedure is performed the factory default settings launch the **Sample Applications** window displays. Application specific shells may provide application specific windows instead of the **Demo window**. These screens also appear when a cold boot is performed.

If the mobile computer does not power on, see [Resetting the Mobile Computer on page 1-11](#).

Calibration Screen

Use the **Calibration** screen to align the touch screen:

1. Remove the stylus from the stylus holder.
2. Carefully press and briefly hold the tip of stylus on the center of the **Calibration** screen target. Repeat the procedure as the target moves and stops at different locations on the screen. This enters the new calibration settings.

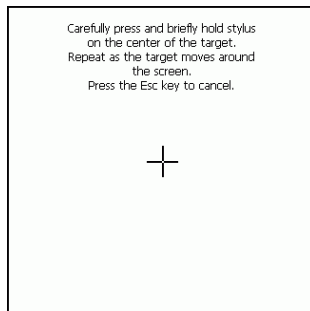

Figure 1-11 Calibration Screen

- Once all of the new calibration settings are input, tap the screen or press ENTER button to save the new calibration settings. Press ESC to discard the new calibration settings.

Resetting the Mobile Computer

Windows CE Devices

If the mobile computer stops responding to input, reset it. There are two reset functions, warm boot and cold boot. A warm boot restarts the mobile computer by closing all running programs. All data that is not saved is lost.

A cold boot also restarts the mobile computer, but erases all stored records and entries from RAM. In addition it returns formats, preferences and other settings to the factory default settings.

Perform a warm boot first. If the mobile computer still does not respond, perform a cold boot.

Performing a Warm Boot

To perform a warm boot:

- Press the **Power** button for five seconds. As soon as the MC31XX starts to boot release the **Power** button.



CAUTION Files that remain open during a warm boot may not be retained.

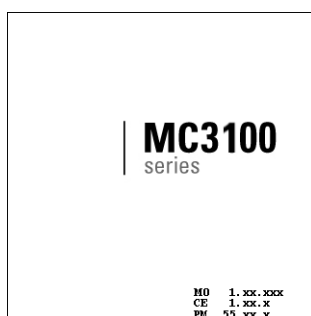

Figure 1-12 Splash Screen (Warm Boot)

Performing a Cold Boot

A cold boot restarts the mobile computer and erases all user stored records and entries from RAM. *Never perform a cold boot unless a warm boot does not solve the problem.*



CAUTION Cold boot resets the mobile computer, to the default settings. All added applications and all stored data are removed. Do not cold boot without support desk approval.

To perform a cold boot:

1. Simultaneously press and then release the **1**, **9** and **Power** keys. Do not hold down any other keys or buttons. As the mobile computer initializes, the splash window, [Figure 1-13](#), appears.

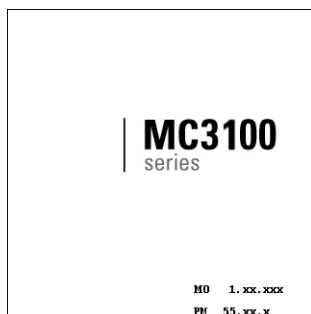

Figure 1-13 *Splash Screen (Cold Boot)*

2. Calibrate the touch screen. See [Calibration Screen on page 1-10](#) to calibrate the mobile computer screen.

Windows Mobile 6.1 Devices

There are three reset functions, warm boot, cold boot and clean boot. A warm boot restarts the mobile computer and closes all running programs. A cold boot also restarts the mobile computer and closes all running programs but also initializes some drivers. Data saved in flash memory or a memory card is not lost.

Perform a warm boot first. This restarts the mobile computer and saves all *stored* records and entries. If the mobile computer still does not respond, perform a cold boot.

Performing a Warm Boot

To perform a warm boot press the **Power** button for five seconds. As soon as the MC31XX starts release the **Power** button.

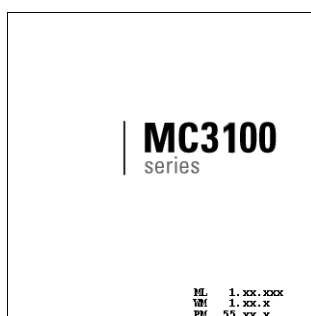

Figure 1-14 *Splash Screen (Warm Boot)*

Performing a Cold Boot

To perform a cold boot, simultaneously press and then release the **1**, **9** and **Power** keys. Do not hold down any other keys or buttons.

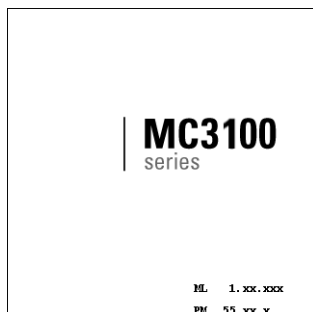

Figure 1-15 Splash Screen (Cold Boot)

Performing a Clean Boot



CAUTION A clean boot should only be performed by an authorized system administrator. You must connect the MC31XX to AC power during a clean boot.

Removing AC power from the MC31XX during a clean boot may render the MC31XX inoperable.

A clean boot resets the MC31XX to the factory default settings. All data in the **Application** folder is retained. You must download the Clean Boot Package file from the Support Central web site (<http://www.zebra.com/support>) and install on the MC31XX.

To perform a clean boot:

1. Download the MC31XX Clean Boot Package from the Support Central web site. Follow the instructions included in the package for installing the package onto the MC31XX.
2. Simultaneously press and release the **Power** button and the **1** and **9** keys.
3. Immediately, as soon as the device starts to boot and before the splash screen is visible, press and hold the left scan button.
4. Insert the MC31XX into a powered cradle or cable.
5. The MC31XX updates and then re-boots.
6. After successful clean boot, the calibration screen appears.

Waking the Mobile Computer

The wakeup conditions define what actions wake up the mobile computer after it has gone into suspend mode. The mobile computer can go into suspend mode by either pressing the Power button or automatically by Control Panel time-out settings. These settings are configurable and the factory default settings are shown in [Table 1-2](#).

Table 1-2 Wakeup Default Settings

Condition for Wakeup	Power Button	Automatic Time-out
AC power is applied.	No	Yes
Mobile computer is inserted into a cradle.	No	Yes
Mobile computer is removed from a cradle.	No	Yes
Mobile computer is connected to a USB device.	No	Yes
Mobile computer is disconnected from a USB device.	No	Yes
A key is pressed.	No	Yes
The scan triggered is pressed.	No	Yes
The screen is touched.	No	No
Wireless LAN activity is detected.	No	No
USB Host	No	No
On Motion	Yes	Yes
Bluetooth	Yes	Yes

To access the Wakeup settings:

On Windows Mobile 6.1 devices, tap **Start > Settings > Power icon > Wakeup** tab.

On WinCE 6.0 devices, tap **Start > Settings > Control Panel > Power icon > Wakeup** tab.

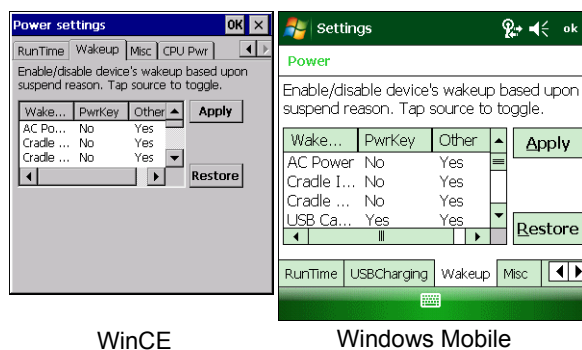

WinCE

Windows Mobile

Figure 1-16 Wakeup Tab

Main Battery Removal

To remove the main battery from an MC31XXS/R:

✓ **NOTE** On devices with Windows Mobile 6.5.3, a dialog box appears when pressing the Power button. See [Removing the Battery on page C-13](#) for more information.

1. If the MC31XXS/R is in suspend mode, press the Power button to wake the device.
2. Press the power button to place the MC31XXS/R in suspend mode.
3. Wait for the red Decode LED to turn on and then turn off.
4. Rotate the latches to the open position.



CAUTION Do not lift up on the latches when removing the door. Lift up on the handstrap only.

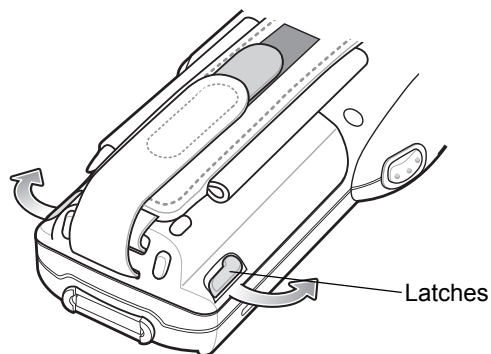

Figure 1-17 Open Latches

5. Lift the door off, bottom first.

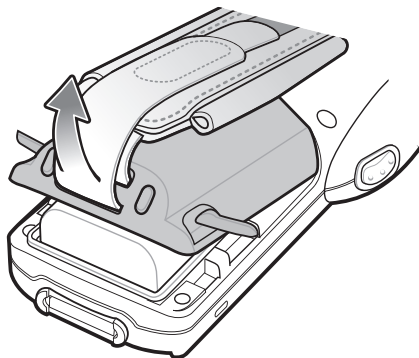

Figure 1-18 Lift Battery Door

6. With finger, press the battery clip in (at the top of the battery) and lift the battery out top first.



WARNING! Do not use a tool to remove the battery.

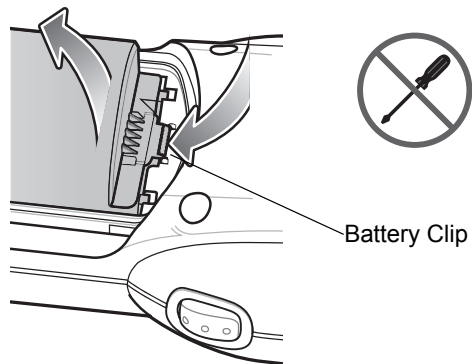

Figure 1-19 Remove Battery

To remove the main battery from an MC3190G:

✓ **NOTE** On devices with Windows Mobile 6.5.3, a dialog box appears when pressing the Power button. See [Removing the Battery on page C-13](#) for more information.

1. If the MC3190G is in suspend mode, press the Power button to wake the device.
2. Press the Power button to place the MC3190G in suspend mode.
3. Wait for the red Decode LED to turn on and then turn off.
4. Rotate the latches to the open position.

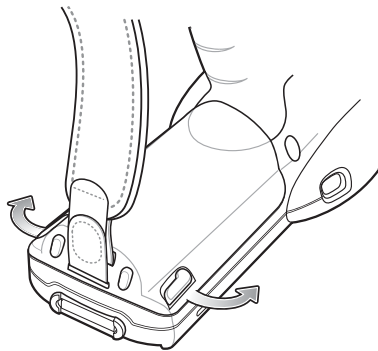

Figure 1-20 Open Latches



CAUTION Do not lift up on the latches when removing the door. Lift up on the handstrap only.

5. Lift the door off, bottom first.

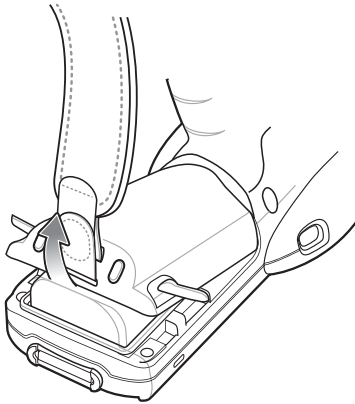

Figure 1-21 *Lift Door*

6. With two finger, press the battery toward the bottom of the mobile computer and lift the battery out top first.



WARNING! Do not use a tool to remove the battery.

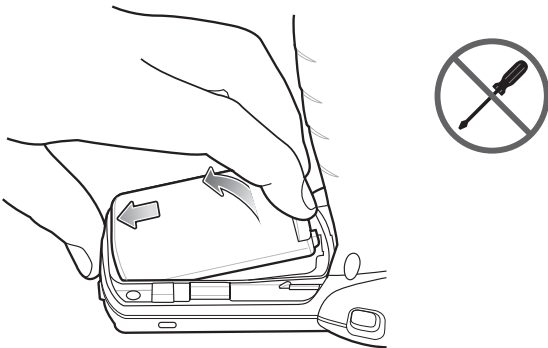

Figure 1-22 *Press the Battery Toward Bottom of the MC3190G*

Handstrap Removal and Replacement (MC31XXS/R)

To remove the handstrap:

1. Use a #00 Phillips screwdriver to remove the screws.
2. Lift the mounting clip.
3. Slide the mounting clip out of the strap loop.
4. Open the handstrap flap and pull the handstrap through the battery door mounting slot.

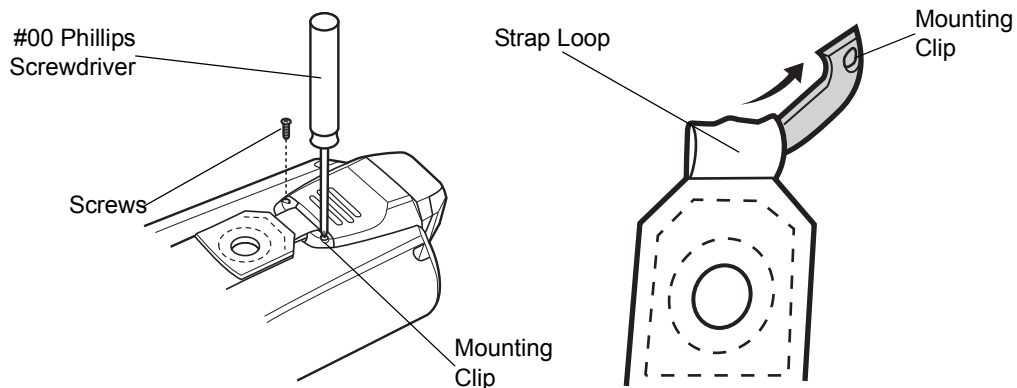

Figure 1-23 *Strap/Door Removal and Replacement (MC31XXS/R)*

To replace the handstrap:

1. Feed the mounting clip through the strap loop.
2. Secure the mounting clip to the housing using the two screws.
3. Feed the handstrap through the slot on the battery door.
4. Attach the hook material to the loop material and press together.

Handstrap Removal and Replacement (MC3190G)

To remove the handstrap:

1. Slip the button through the loop.

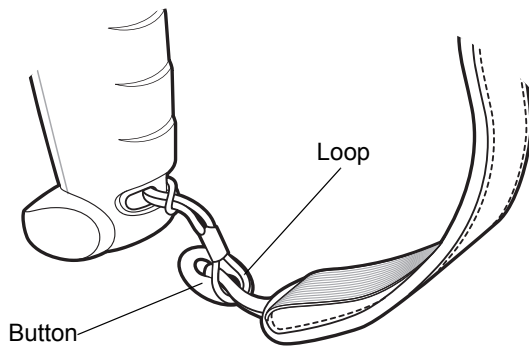

Figure 1-24 Remove Button from Loop

2. Remove loop section from handle.
3. Separate the loop and hook tape and pull the handstrap through the slot in the battery door.

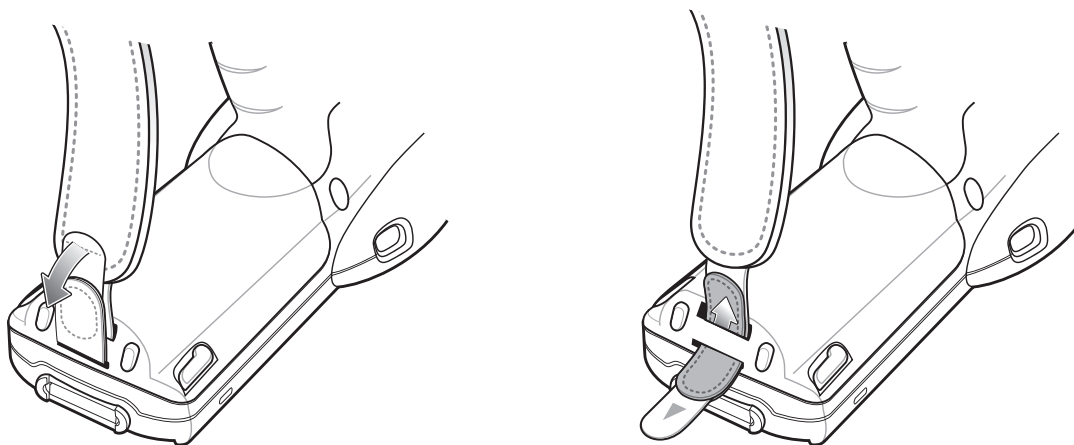

Figure 1-25 Remove Handstrap from Battery Door Slot

To install a new handstrap:

1. Insert one end of the loop section into the mounting slot in the handle.
2. Thread the other end of the loop section through the loop and pull to tighten the loop.

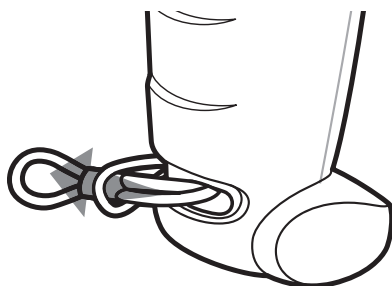

Figure 1-26 Thread Loop

3. Slip the button into the loop section.

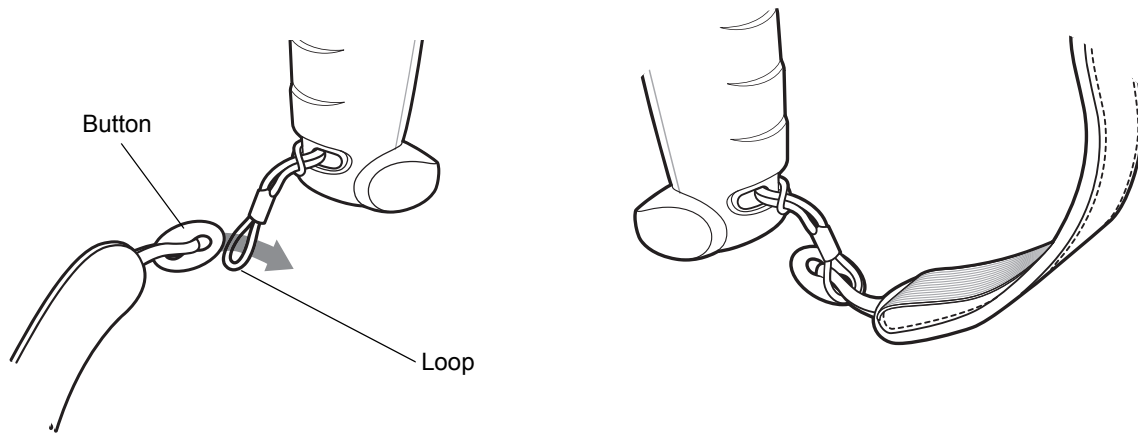

Figure 1-27 *Slip Button Through Loop*

4. Thread the end of the handstrap into the slot in the battery door.

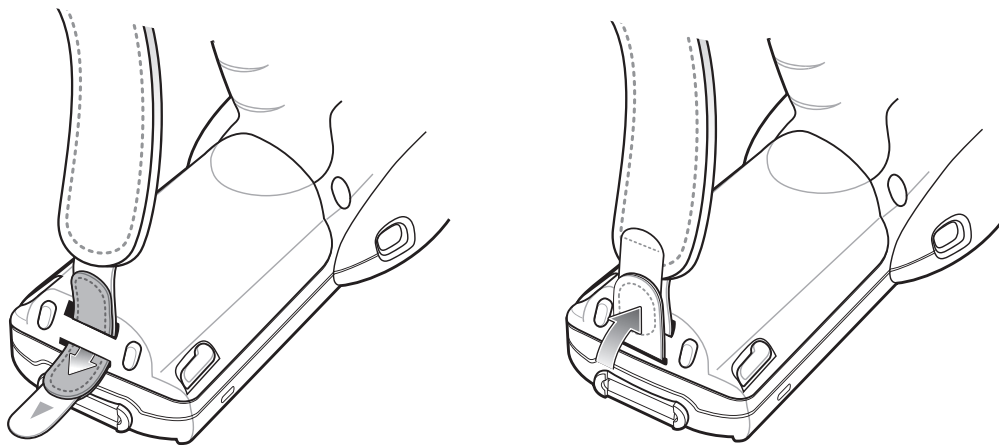

Figure 1-28 *Thread Handstrap into Battery Door Slot*

5. Press the hook material against the loop material.

Chapter 2 Accessories

Introduction

The MC31XX accessories provide a variety of product support capabilities. Accessories include cradles, cables and spare battery chargers. [Table 2-1](#) lists the MC31XX accessories.

Table 2-1 MC31XX Accessories

Accessory	Part Number	Description
Cradles		
Single Slot Serial/USB Cradle	CRD3000-1001RR	Charges the mobile computer main battery and a spare battery, and synchronizes the mobile computer with a host computer through either a serial or USB connection.
Four Slot Ethernet Cradle	CRD3000-4001ER	Charges up to four mobile computers and provides Ethernet communications.
Four Slot Charge Only Cradle	CHS3000-4001CR	Charges up to four mobile computers.
Mounting Bracket	8710-050006-01R	Used to mount four slot cradles onto a wall.
Chargers		
Four Slot Spare Battery Charger	SACX000-4000CR	Charges up to four mobile computer spare batteries.
Universal Battery Charger (UBC)	UBC2000-I500DR	Chargers up to four batteries.
MC31XX Universal Battery Charger Adapter (UBC)	21-32665-45AR	Adapts the UBC for use with MC31XX batteries.
UBC Mounting Bracket	KT-32665-01R	Used to mount UBC onto a wall.
Charge Only Cable	25-70103-03R	Plugs into a vehicle cigarette lighter to charge the mobile computer.
Auto-charge Cable	25-67873-03R	Provides power to the mobile computer

Table 2-1 MC31XX Accessories (Continued)

Accessory	Part Number	Description
Power Supply for Single Slot Serial/USB Cradle	KT-14000-148R	Provides power to the Single Slot Serial/USB Cradle and Four Slot Battery Charger.
Power Supply for Four Slot Cradles	50-14000-241R	Provides power to the Four Slot Charge Only and Ethernet Cradles.
Power Supply for Charging Cables	50-14000-249R	Provides power to the charge only, serial cable and USB cable.
US AC Line Cord	23844-00-00R	Provides power to the 3-wire power supplies.
Cables		
USB Client Charge Cable	25-67868-03R	Provides USB client communication capabilities and charges the mobile computer.
USB Host Charge Cable	25-67869-03R	Provides USB host communication capabilities and charges the mobile computer.
RS232 Charge Cable	25-67866-03R	Provides RS232 communication capabilities and charges the mobile computer.
O'Neil Printer Cable	25-91512-01R	Provides printer specific communication capabilities.
Zebra Printer Cable	25-91513-01R	Provides printer specific communication capabilities.
Zebra Road Warrior Printer Cable	25-91514-01R	Provides printer specific communication capabilities.
Single Slot Cradle RS232 Cable	25-63852-01R	Provides serial host communication through the Single Slot Serial/USB cradle.
Single Slot Cradle USB Cable	25-68596-01R	Provides USB communication through the Single Slot Serial/USB cradle.
Miscellaneous		
Magnetic Stripe Reader	MSR3000-100R	Reads magnetic stripe cards.
Modem Dongle	MDM9000-100R	Provides modem connectivity through mobile computer or Single Slot Serial/USB cradle.
Modem Adapter Cable	25-63856-01R	Connects Modem Dongle to Single Slot Serial/USB cradle.
Cradle Modem Kit	KT-MC3000SERMODE MR	Provides modem connectivity to the Single Slot Serial/USB cradle. Kit includes Modem Dongle and Modem Adapter Cable.
Modem Kit	KT-70924-01R	Provides modem connectivity to the mobile computer. Kit includes Modem Dongle and Modem Cable.
Modem Cable	25-70924-01R	Connects the Modem Dongle to the mobile computer.

Table 2-1 MC31XX Accessories (Continued)

Accessory	Part Number	Description
Headset Adapter Cable: MC3100 2.5 mm jack with unique locking screw to bare wires	25-124389-01R	Connects a headset with unique Quick Disconnect Connector to the mobile computer. Bare wires can be soldered to user defined unique Quick Disconnect Connector.
Headset Adapter cable: MC3100 2.5mm jack with unique locking screw to Headsets like VXI and RCH50	25-124411-01R	Connects a VXI and RCH50 headset to the mobile computer.
MC31XXR Audio Jack Cover	11-128366-02R	Replacement audio jack cover for the MC31XXR (5-pack).
MC31XXS Audio Jack Cover	11-128366-01R	Replacement audio jack cover for the MC31XXS (5-pack)
MC3190G Audio Jack Cover	11-128366-03R	Replacement audio jack cover for the MC3190G (5-pack)
2740 mAh Battery	BTRY-MC3XKAB0E BTRY-MC3XKAB0E-10 BTRY-MC3XKAB0E-50	Replacement standard capacity (1X) battery. 10-pack 50-pack.
4800 mAh Battery	BTRY-MC31KAB02 BTRY-MC31KAB02-10 BTRY-MC31KAB02-50	Replacement extended capacity (2X) battery. 10-pack 50-pack.
UBC Power Supply Kit	KT-32665-02R	Provides power to the Universal Battery Charger.
DC Line Cord	50-16002-042R	Provides power from the power supply to the Four Slot Ethernet cradle or Four Slot Charge Only cradle.
MC31XXR/S Stylus	11-42794-03R	Replacement stylus (3-pack).
MC31XXR/S Stylus	11-42794-50R	Replacement stylus (50-pack).
MC31XXR/S Tether	11-42722-03R	Replacement tether (3-pack).
MC31XXR/S Tether	11-42722-50R	Replacement tether (50-pack).
MC31XXR/S Stylus and Tether Kit	11-43912-03R	Replacement stylus and tether kit (3-pack).
MC31090G Stylus	KT-68144-10R	Replacement stylus for MC3190G (3-pack).
MC3190G Stylus	KT-68144-50R	Replacement stylus for MC3190G (50-pack).
MC3190G Stylus and Tether	KT-81680-03R	Replacement stylus and tether for MC3190G (3-pack).
MC3190G Stylus and Tether	KT-81680-50R	Replacement stylus and tether for MC3190G (50-pack).
MC3190G Handstrap	SG-MC3123242-01R	Replacement handstrap for MC3190G.

Table 2-1 MC31XX Accessories (Continued)

Accessory	Part Number	Description
MC3190G Handstrap Button	KT-97258-01R	Replacement button for MC3190G handstrap (250-pack).
MC31XXR/S Handstrap	SG-MC3123243-01R	Replacement handstrap for MC31XXR and MC31XXS.
MC31XX 1X Battery Door	KT-128372-01R	Replacement 1X battery door for MC31XXR and MC31XXS.
MC31XX 2X Battery Door	KT-128373-01R	Replacement 2X battery door for MC31XXR and MC31XXS.
MC3190G 2X Battery Door	KT-128374-01R	Replacement 2X battery door for MC3190G.
Plastic Holster	8710-050005-01R	Provides a clip on holder for the MC31XXR and MC31XX S.
Fabric Holster	SG-MC3021212-01R	Provides a soft, clip on holder and a shoulder strap for the mobile computer.
Fabric Holster	11-76201-02R	Provides a soft holder for MC3190G and used with a shoulder strap.
Belt	11-08062-02R	Belt for fabric holster.
MC3190G Rubber Boot	11-72959-04R	Provides additional protection for both the laser and imager configurations.
MC31XXS Rubber Boot	11-70899-04R	Provides additional protection for both the laser and imager configurations.
MC31XXR Rubber Boot	BOOTSCANTURRETR	Provides additional protection for the MC31XXR.
Screen protector	KT-82057-03R	Replacement screen protectors (3-pack).

Single Slot Serial/USB Cradle



CAUTION Ensure that you follow the guidelines for battery safety described in [Battery Safety Guidelines on page 8-1](#).

This section describes how to set up and use the Single Slot Serial/USB cradle. For cradle setup, see [Figure 2-2](#). For communications setup procedures, see [Chapter 3, ActiveSync](#).

The Single Slot Serial/USB cradle:

- Provides 5.4VDC power for operating the mobile computer, charging the battery and charging a spare battery.
- Provides a serial port and a USB port (mini AB receptacle) for data communication between the mobile computer and a host computer or other serial devices (e.g., a printer).
- Synchronizes information between the mobile computer and a host computer. With customized or third party software, it can also synchronize the mobile computer with corporate databases.

- Provides serial connection through the serial pass-through port for communication with a serial device, such as a host computer. For communication setup procedures, see [Chapter 3, ActiveSync](#).
- Provides USB connection through the USB pass-through port for communication with a USB device, such as a host computer. For communication setup procedures, see [Chapter 3, ActiveSync](#).

Setup

- ✓ **NOTE** The cradle requires a dedicated port on the host computer. Select either serial or USB for communications, do not connect the cradle to both serial and USB ports.

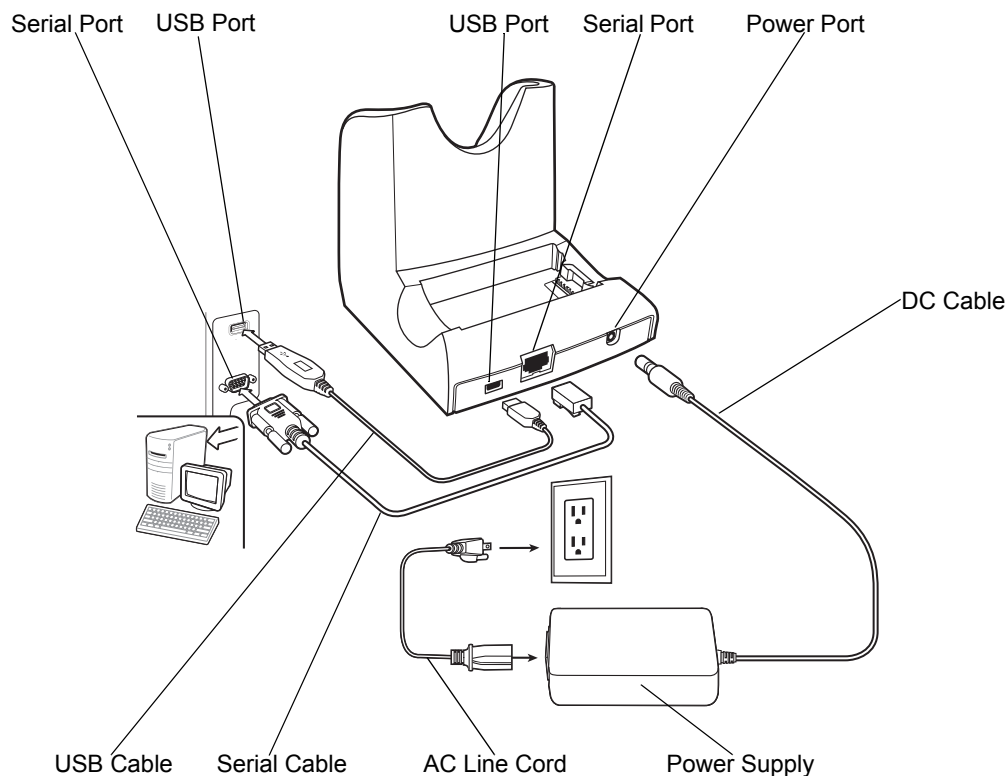

Figure 2-1 Single Slot Serial/USB Cradle Setup

Battery Charging

The Single Slot Serial/USB cradle can charge the mobile computer main battery and a spare battery simultaneously.

To charge the mobile computer:

1. Connect the Single Slot Serial/USB cradle to a Zebra approved power source.
2. Slide the mobile computer into the mobile computer slot. The amber Charge LED Indicator indicates the mobile computer battery charging status. The Standard Battery charges in less than five hours and the Extended Life Battery charges in less than eight hours. See [Table 2-2](#) for charging status indications.

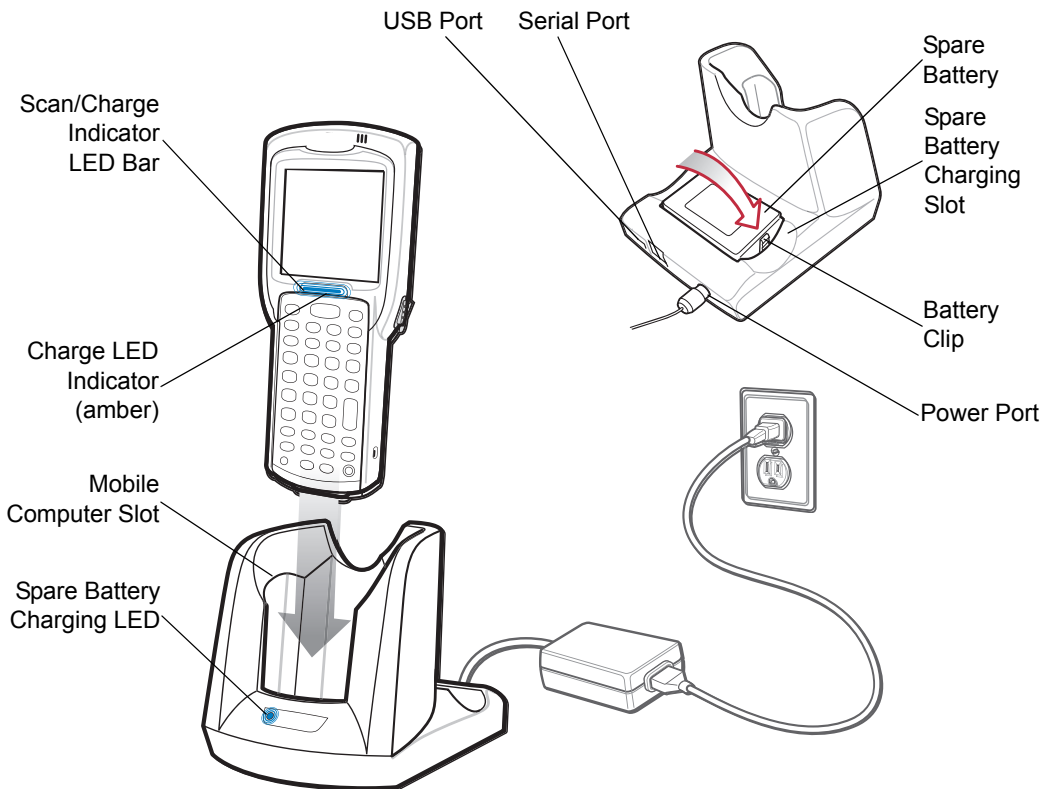

Figure 2-2 Single Slot Serial/USB Cradle

3. When charging is complete, remove the mobile computer from the mobile computer slot.

To charge a spare battery:

1. Connect the Single Slot Serial/USB cradle to a Zebra approved power source.
2. Insert the spare battery into the spare battery charging slot, bottom first, and pivot the top of the battery down onto the contact pins.
3. Gently press down on the battery to ensure proper contact.
4. The cradle Spare Battery Charging LED indicates the spare battery charging status. The Standard Battery usually charges in less than five hours and the Extended Life Battery usually charges in less than eight hours. See [Table 2-2](#) for charging status indications.
5. When charging is complete, press the battery clip and lift the battery out of the slot.



WARNING! Do not use a tool to remove the battery.

LED Charge Indications

The Single Slot Serial/USB cradle uses the amber Charge LED Indicator to indicate MC31XX battery charging status and the Spare Battery Charging LED to indicate spare battery charging status. See [Table 2-2](#) for charging status indications.

Table 2-2 LED Charging Status Indicators

LED	Indication
Mobile Computer Charging (LED on mobile computer)	
Off	Mobile computer not placed correctly in the cradle; cable not connected correctly; charger is not powered.
Fast Blinking Amber	Error in charging; check placement of mobile computer.
Slow Blinking Amber	Mobile computer is charging.
Solid Amber	Charging complete. Note: When the battery is initially inserted in the mobile computer, the amber LED flashes once if the battery power is low or the battery is not fully inserted.
Spare Battery Charging (LED on cradle)	
Off	No spare battery in slot; spare battery not placed correctly; cradle is not powered.
Fast Blinking Amber	Error in charging; check placement of spare battery.
Slow Blinking Amber	Spare battery is charging.
Solid Amber	Charging complete.

Communication Setup

To connect the Single Slot Serial/USB cradle to a serial or USB device:

1. Connect Single Slot Serial/USB cradle cable to the communications port.
2. Slide the mobile computer into the mobile computer slot. The amber Charge LED Indicator indicates the mobile computer battery charging status and that the mobile computer is seated in the cradle. For more information on communications setup procedures, see [Chapter 3, ActiveSync](#).

Four Slot Charge Only Cradle



CAUTION Ensure that you follow the guidelines for battery safety described in [Battery Safety Guidelines on page 8-1](#).

The Four Slot Charge Only cradle:

- Provides 5.4VDC power for operating the mobile computer and charging the battery.
- Simultaneously charges up to four mobile computers.

Setup

Connect the Four Slot Charge Only cradle to a Zebra approved power source.

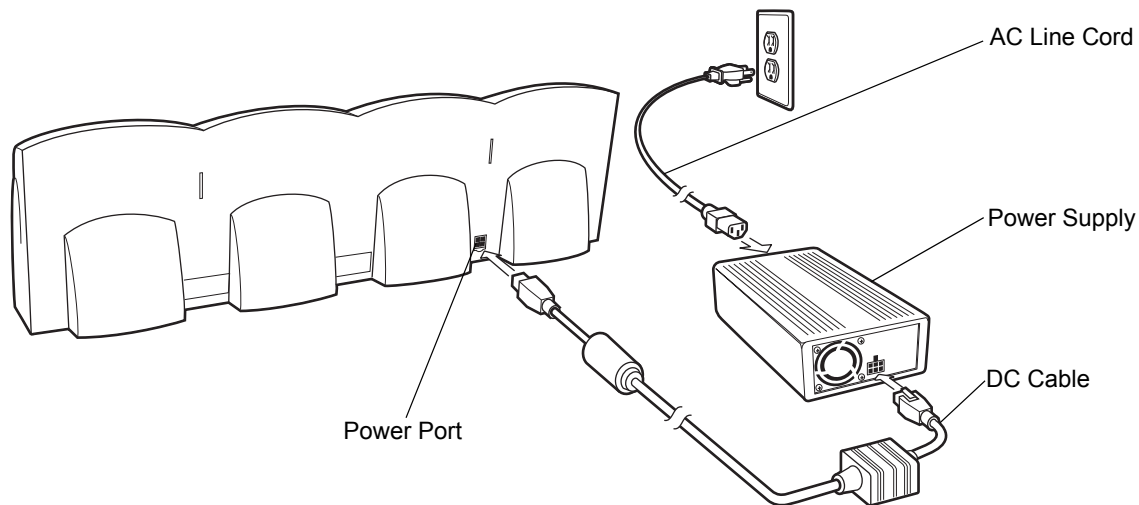

Figure 2-3 *Four Slot Charge Only Cradle, Setup*

Battery Charging

The Four Slot Charge Only cradle can charge up to four mobile computers simultaneously.

To charge the mobile computer:

1. Connect the Four Slot Charge Only cradle to a Zebra approved power source.
2. Slide the mobile computer into the mobile computer slot.

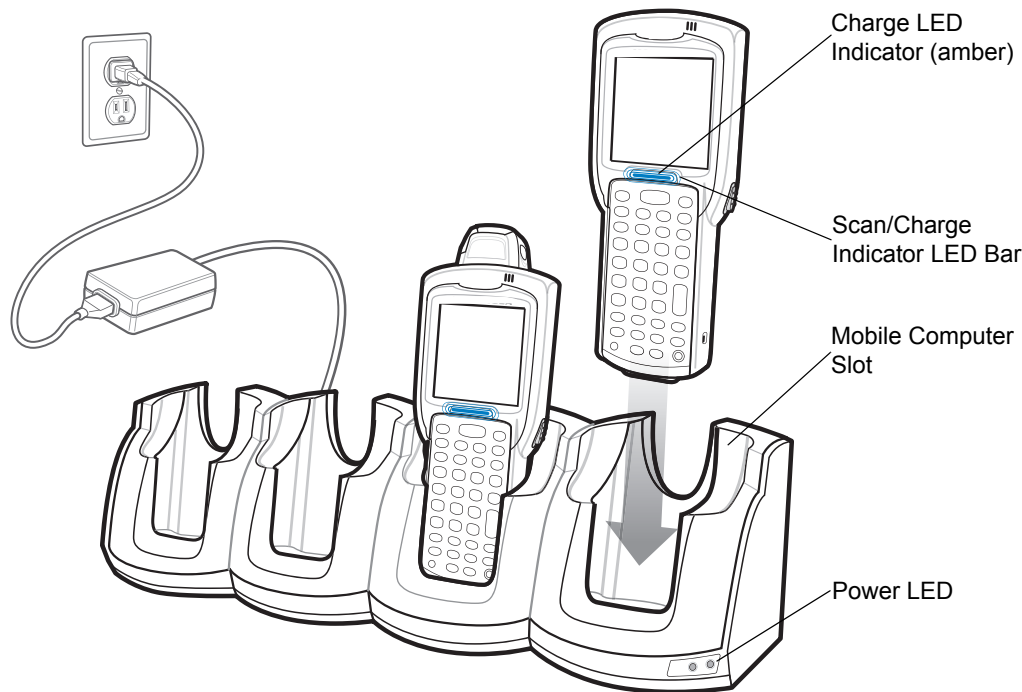

Figure 2-4 Four Slot Charge Only Cradle

3. The mobile computer amber Charge LED Indicator indicates the mobile computer battery charging status. The Standard Battery usually charges in less than five hours and the Extended Life Battery usually charges in less than eight hours. See [Table 2-2 on page 2-7](#) for charging status indications.
4. When charging is complete, remove the mobile computer from the cradle.

Power LED

The green Power LED lights to indicate that the Four Slot Charge Only cradle is connected to a power source.

LED Charge Indications

The Four Slot Charge Only cradle uses the amber Charge LED Indicator to indicate battery charging status. See [Table 2-2 on page 2-7](#) for charging status indications.

Four Slot Ethernet Cradle



CAUTION Ensure that you follow the guidelines for battery safety described in [Battery Safety Guidelines on page 8-1](#).

This section describes how to set up and use a Four Slot Ethernet cradle with the mobile computer.

The Four Slot Ethernet cradle:

- Provides 5.4 VDC power for operating the mobile computer.
- Connects the mobile computer (up to four) to an Ethernet network.

You cannot ActiveSync using the Four Slot Ethernet cradle. To ActiveSync with a host computer, use the Single Slot Serial/USB cradle.

Setup

Connect the Ethernet cradle (Ethernet port 1) to an Ethernet hub or a port on the host device. Connect the Ethernet cradle (power port) to a Zebra approved power supply.

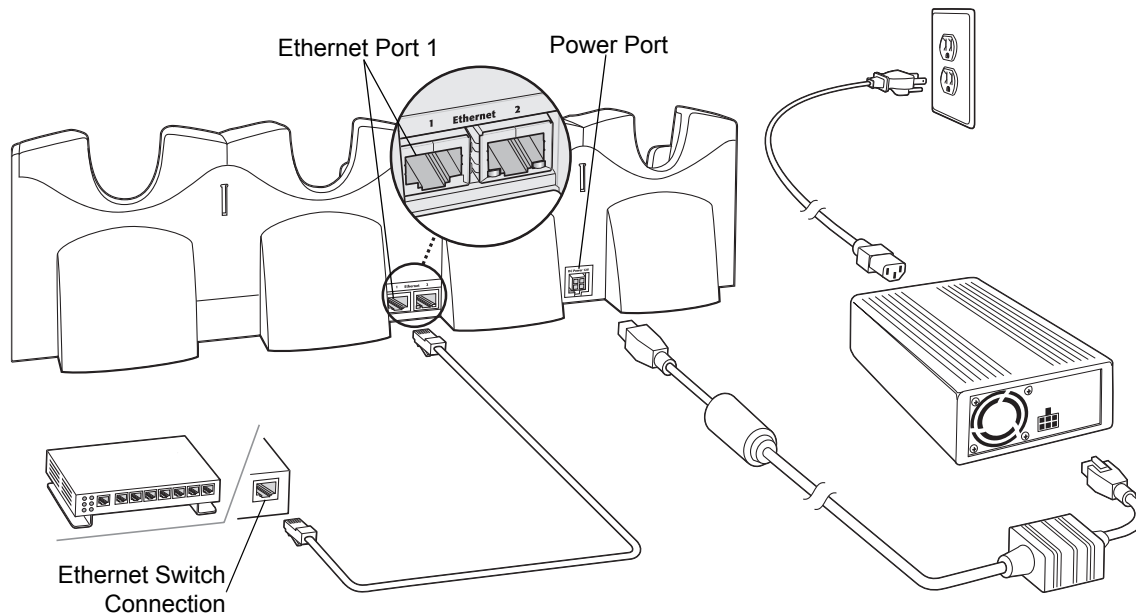

Figure 2-5 Four Slot Ethernet Cradle Connection

Ethernet Cradle Drivers (Windows CE 6.0)

The Ethernet cradle drivers are pre-installed on the MC31XX and initiate automatically when the MC31XX is placed in a properly connected Four Slot Ethernet cradle.

When the mobile computer is inserted into the Four Slot Ethernet cradle, the LAN icon indicates that the mobile computer is connected to a network.

Double-tap the **LAN** icon to open the **LANNDS1** window. This window displays the TCP/IP information for the mobile computer.

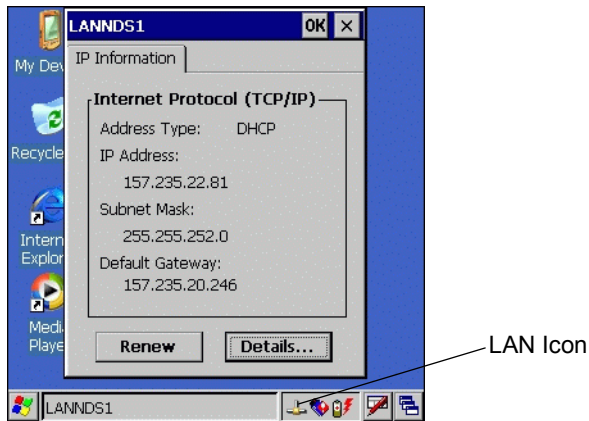

Figure 2-6 LANNDS1 Window

Ethernet Cradle Drivers (Windows Mobile 6.1)

The MC31XX includes Ethernet cradle drivers that initiate automatically when you place the MC31XX in a properly connected Four Slot Ethernet cradle. After inserting the MC31XX, configure the Ethernet connection:

Tap **Start > Settings > Connections** tab > **WiFi** icon. The **Configure Network Adapters** window appears.

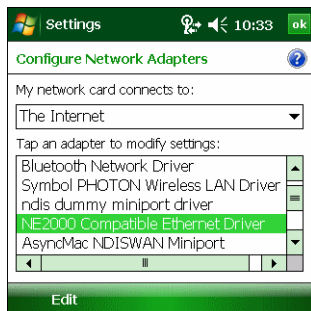

Figure 2-7 Configure Network Adapters Window

1. In the **My network card connects to:** drop-down list, select the appropriate connection.
2. In the **Tap an adapter to modify settings:** list, select **NE2000 Compatible Ethernet Driver**.

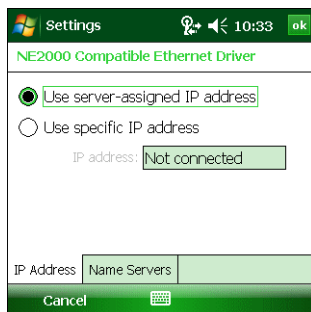

Figure 2-8 IP Address Tab

3. In the **IP address** window, select the appropriate radio button:

- **Use server-assigned IP address**

or

- **Use specific IP address.** Enter the IP address, Subnet mask, and Default gateway, as needed.

4. Tap the **Name Servers** tab.

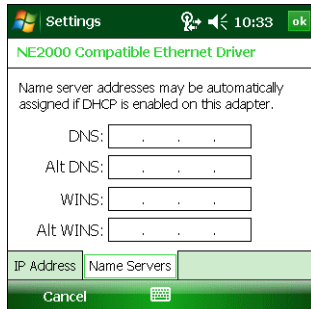

Figure 2-9 Name Servers Tab

5. Enter the appropriate DNS, Alt DNS, WINS, and Alt WINS server addresses.
6. Tap **ok**.
7. Tap **ok** to exit.

Charging and Communication

Insert the mobile computer into a slot to begin charging and initiate communication.

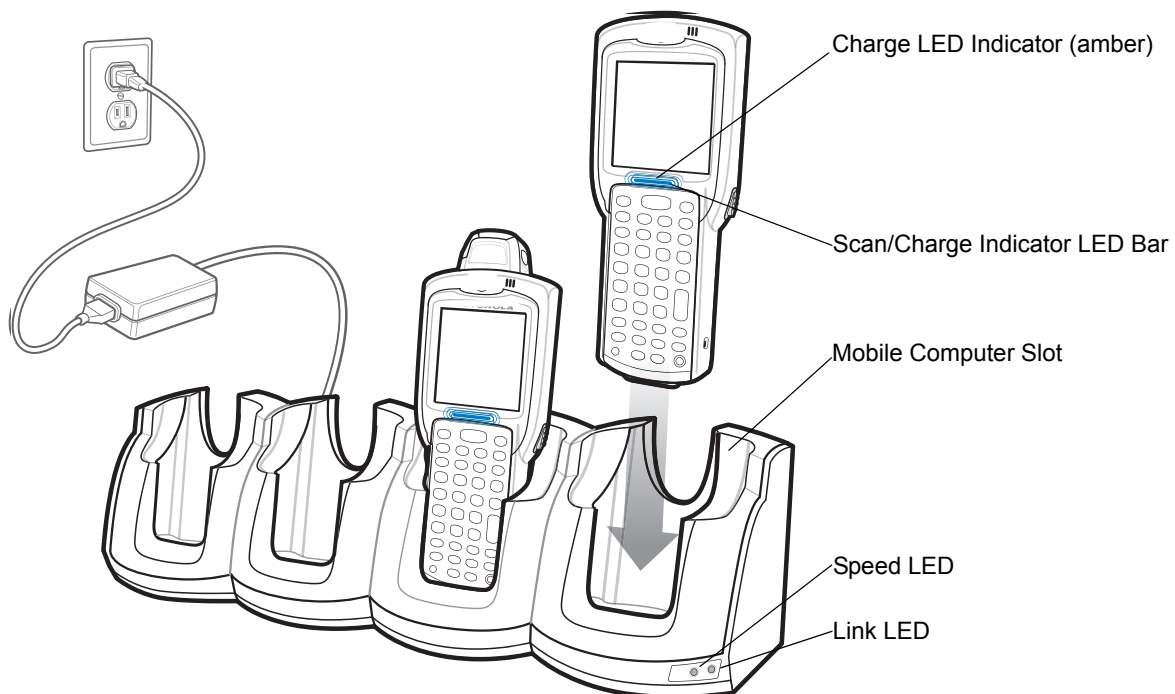

Figure 2-10 Four Slot Ethernet Cradle

LED Charge Indications

The charge LED shows the status of the battery charging in the mobile computer. The Standard Battery usually charges in less than five hours and the Extended Life Battery usually charges in less than eight hours. See [Table 2-2 on page 2-7](#) for charging status indications.

Speed LED

The green Speed LED lights to indicate that the transfer rate is 100 Mbps. When it is not lit it indicates that the transfer rate is 10Mbps.

Link LED

The yellow Link LED blinks to indicate activity, or stays lit to indicate that a link is established. When it is not lit it indicates that there is no link.

Daisy chaining Ethernet Cradles

Daisychain up to four cradles to connect several MC31XXs to an Ethernet network. Use either a straight or crossover cable. Daisy-chaining should not be attempted when the main Ethernet connection to the first cradle is 10 Mbps as throughput issues will almost certainly result.

To daisychain cradles:

1. Connect power to each Ethernet cradle to daisychain.
2. Connect an Ethernet cable to Port 1 of the first cradle as shown in [Figure 2-11](#).
3. Connect a second Ethernet cable between Port 2 of the first cradle and Port 1 of the second cradle.
4. Connect additional cradles as described in step 3.

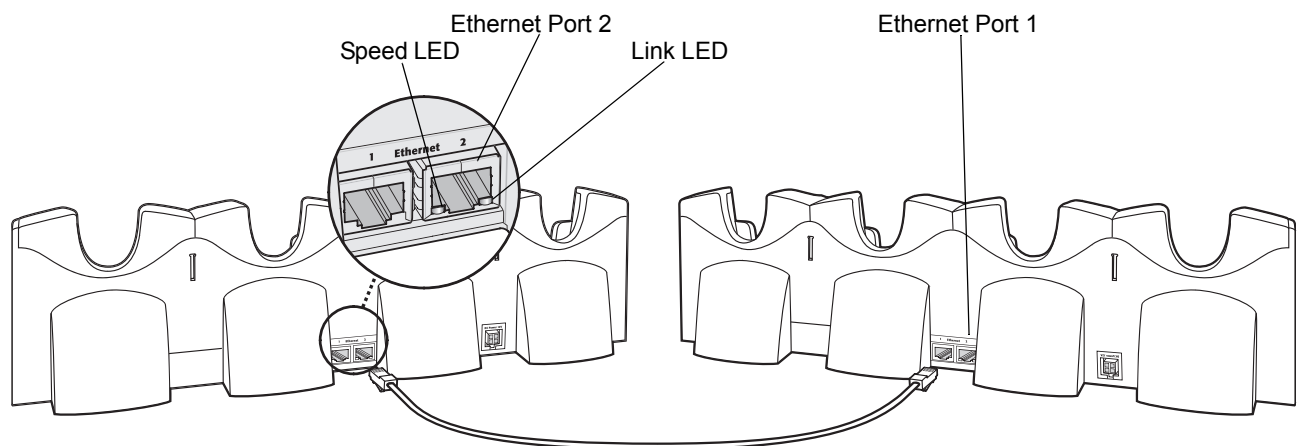

Figure 2-11 Daisy chaining Four Slot Ethernet Cradles

Wall Mount Bracket

Use the optional Wall Mount Bracket to mount a four slot cradle directly to a wall. To attach the Wall Mount Bracket:

1. Use the Wall Mount Bracket as a template and mark the locations of the four mounting screws.
 - ✓ **NOTE** Use fasteners appropriate for the type of wall and the Wall Mount Bracket, mounting slots. The Wall Mount Bracket, mounting slots are designed for a fastener with a #8 pan head.
2. Mount the fasteners to the wall. The screw heads should protrude about a half of an inch from the wall.
3. Slip the Wall Mount Bracket over the screw heads and slide the Wall Mount Bracket down over the screw heads.
4. Tighten the screws to secure the Wall Mount Bracket to the wall.

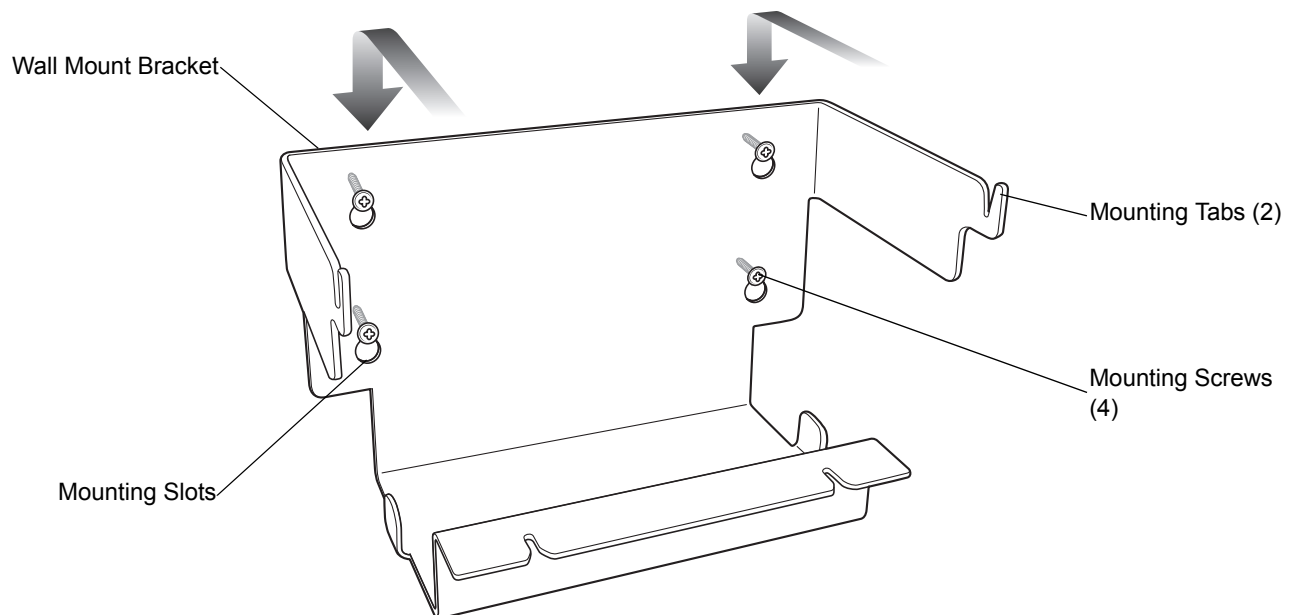

Figure 2-12 Wall Mount Bracket

To mount a four slot cradle:

1. Screw the supplied fasteners into the bottom of the four slot cradle. The screw heads should protrude about a quarter of an inch from the cradle.

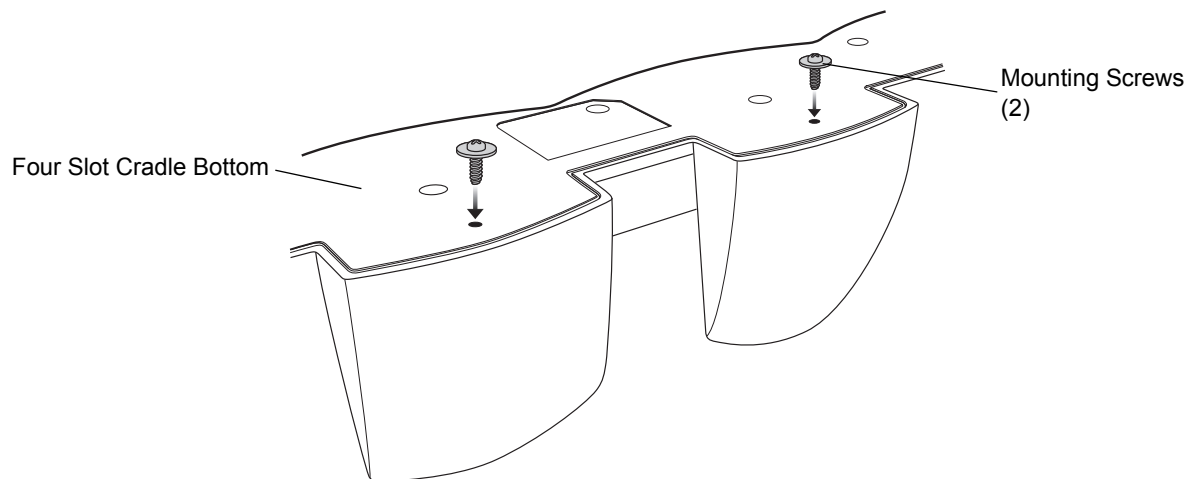

Figure 2-13 Cradle Mounting Screws

2. Align the Wall Mount Bracket mounting tabs with the mounting slots in the back of the four slot cradle. Slip the two mounting tabs into mounting slots.
3. Swing the four slot cradle down onto the mounting bracket and align the mounting screws so that they fit into the screw slots.

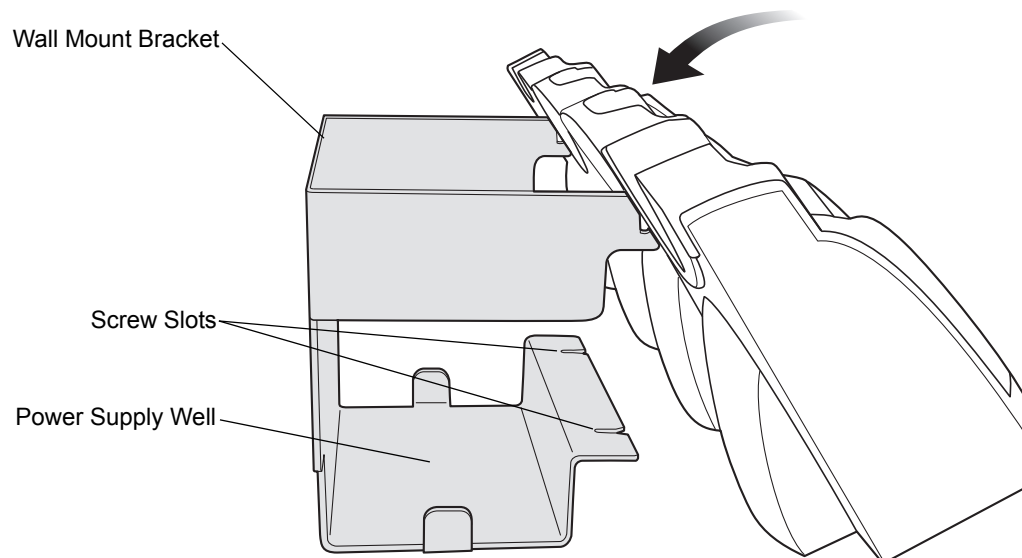

Figure 2-14 Wall Mount Bracket

4. Tighten the mounting screws to secure the four slot cradle to the Wall Mount Bracket.

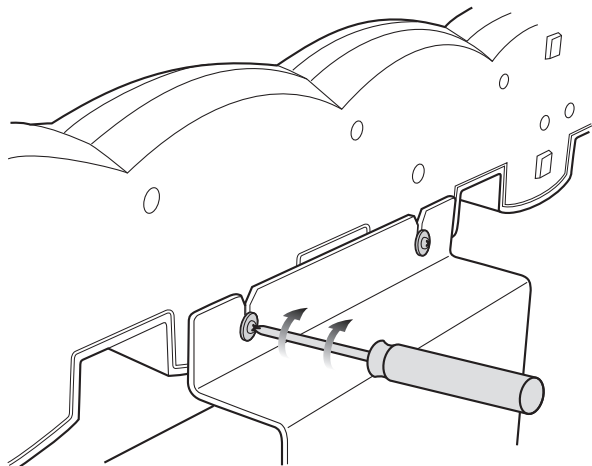

Figure 2-15 *Mounting Screws*

5. Connect the power (see [Figure 2-3 on page 2-8](#)). The power supply should be located in the power supply well.

Four Slot Spare Battery Charger



CAUTION Ensure that you follow the guidelines for battery safety described in [Battery Safety Guidelines on page 8-1](#).

The Four Slot Spare Battery Charger simultaneously charges up to four spare batteries.

Setup

Connect the Four Slot Spare Battery Charger to a Zebra approved power source.

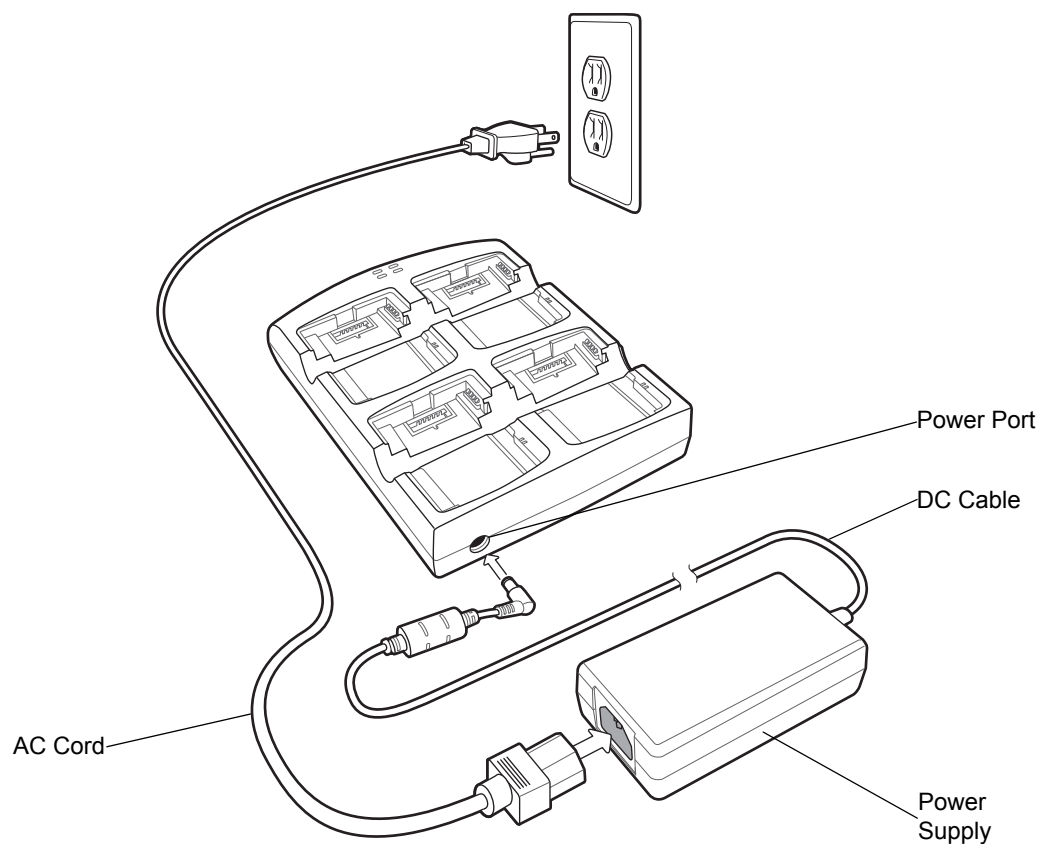

Figure 2-16 *Four Slot Spare Battery Charger Setup*

Spare Battery Charging

To charge up to four MC31XX spare batteries:

1. Insert the spare battery into the spare battery charging slot, bottom first.
2. Pivot the top of the battery down onto the contact pins.

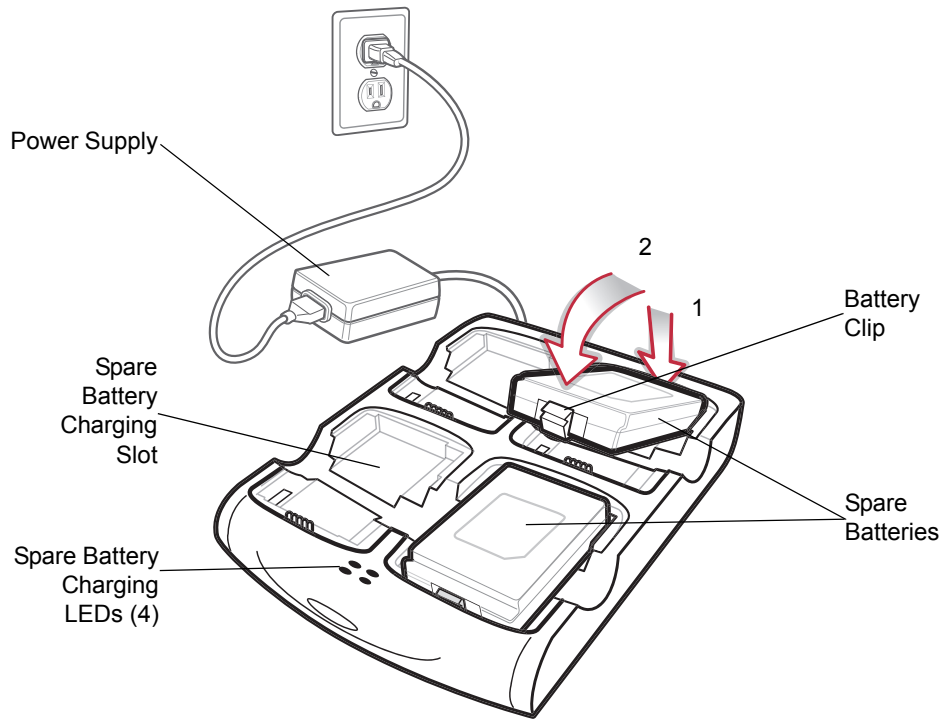

Figure 2-17 Four Slot Spare Battery Charger

3. Gently press down on the battery to ensure proper contact. The Standard Battery usually charges in less than five hours and the Extended Life Battery usually charges in less than eight hours. See [Table 2-2 on page 2-7](#) for charging status indications.
4. When charging is complete, press the battery clip and lift battery out of the slot.



WARNING! Do not use a tool to remove the battery.

LED Charge Indications

The Spare Battery Charging LEDs indicate the spare battery charging status. The Spare Battery Charging LEDs are arranged in the same pattern as the spare battery charging slots so that the charging status of each battery can be identified. See [Table 2-2 on page 2-7](#) for charging status indications.

Cables

This section describes how to setup and use the cables. The cables are available with a variety of connection capabilities.

The following MC31XX Communication/Charge cables are available:

- Serial (RS232) Charge cable (9-pin D female with power input receptacle)
- USB Client Charge cable (standard-A connector and a barrel receptacle for power).

The following printer cables are available directly from the printer manufacturer:

- O'Neil printer cable
- Zebra printer cable.
- Monarch printer cable.

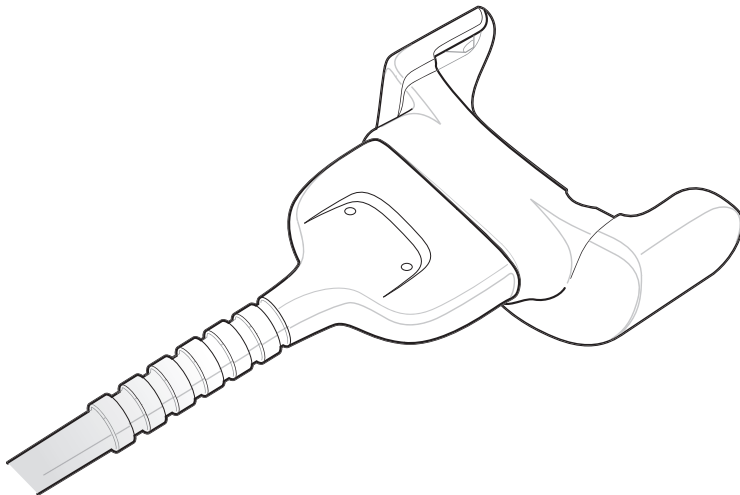

Figure 2-18 Cables (MC31XX Connector)

The MC31XX Communication/Charge cables:

- Provide the mobile computer with operating and charging power when used with the Zebra approved power supply.
- Synchronize information between the mobile computer and a host computer. With customized or third party software, it can also synchronize the mobile computer with corporate databases.
- Provide serial connection through the serial pass-through port for communication with a serial device, such as a host computer. For communication setup procedures, see [Chapter 3, ActiveSync](#).
- Provide USB connection through the USB pass-through port for communication with a USB device, such as a host computer. For communication setup procedures, see [Chapter 3, ActiveSync](#).

Dedicated printer cables, provide communication with a dedicated printer.

Setup

The MC31XX Communication/Charge cables can connect with a serial/USB device, such as a printer or host computer, through its serial or USB port.

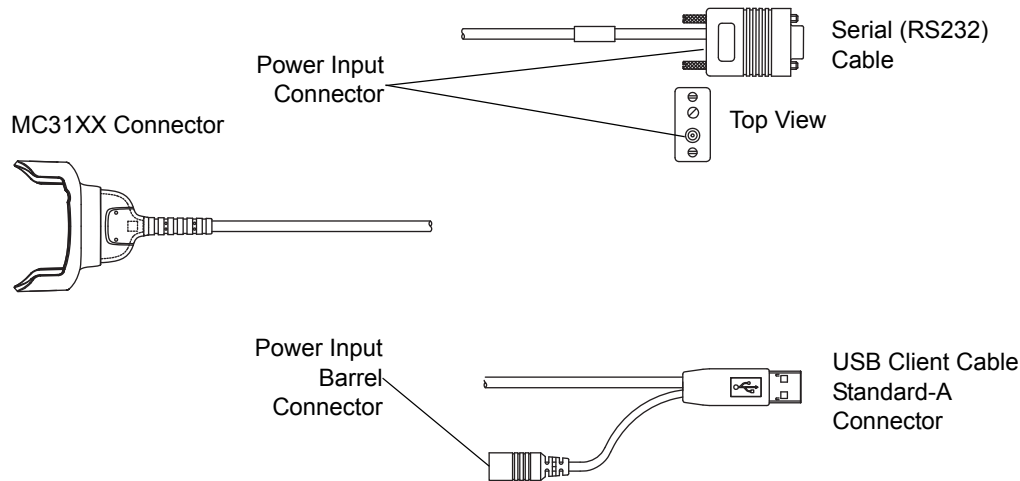

Figure 2-19 MC31XX Communication/Charge Cables

Battery Charging

The MC31XX Communication/Charge cables can charge the mobile computer battery and supply operating power.

To charge the mobile computer battery:

1. Connect the MC31XX Communication/Charge cable power input connector to the Zebra approved power source.
2. Attach the bottom of the mobile computer to the MC31XX connector and gently press in until the snaps latch on the mobile computer.
3. The mobile computer amber Charge LED Indicator indicates the mobile computer battery charging status. The Standard Battery usually charges in less than five hours and the Extended Life Battery usually charges in less than eight hours. See [Table 2-2 on page 2-7](#) for charging status indications.
4. When charging is complete, remove the cable by gently pulling the mobile computer and the cable apart until the snaps release the mobile computer.



WARNING! Do not use a tool to remove the battery.

LED Charge Indications

The MC31XX Communication/Charge cables use the amber Charge LED Indicator to indicate the MC31XX battery charging status. See [Table 2-2 on page 2-7](#) for charging status indications.

Communication Setup

To connect the MC31XX Communication/Charge cables to a serial or USB device:

1. Connect serial/USB end of the MC31XX Communication/Charge cable into the communications port.

2. Connect the MC31XX connector end to the MC31XX Communication/Charge cable to the mobile computer. For more information on communications setup procedures, see [Chapter 3, ActiveSync](#).

Universal Battery Charger (UBC) Adapter



CAUTION Ensure that you follow the guidelines for battery safety described in [Battery Safety Guidelines on page 8-1](#).

The UBC Adapter can be used with a power supply as a standalone spare battery charger or it can be used with the four station UBC2000 to simultaneously charge up to four spare batteries. For additional information on the UBC 2000, refer to the *UBC 2000 Quick Reference Guide*, p/n 70-33188-xx.

Setup

Connect the UBC Adapter to a Zebra approved power source.

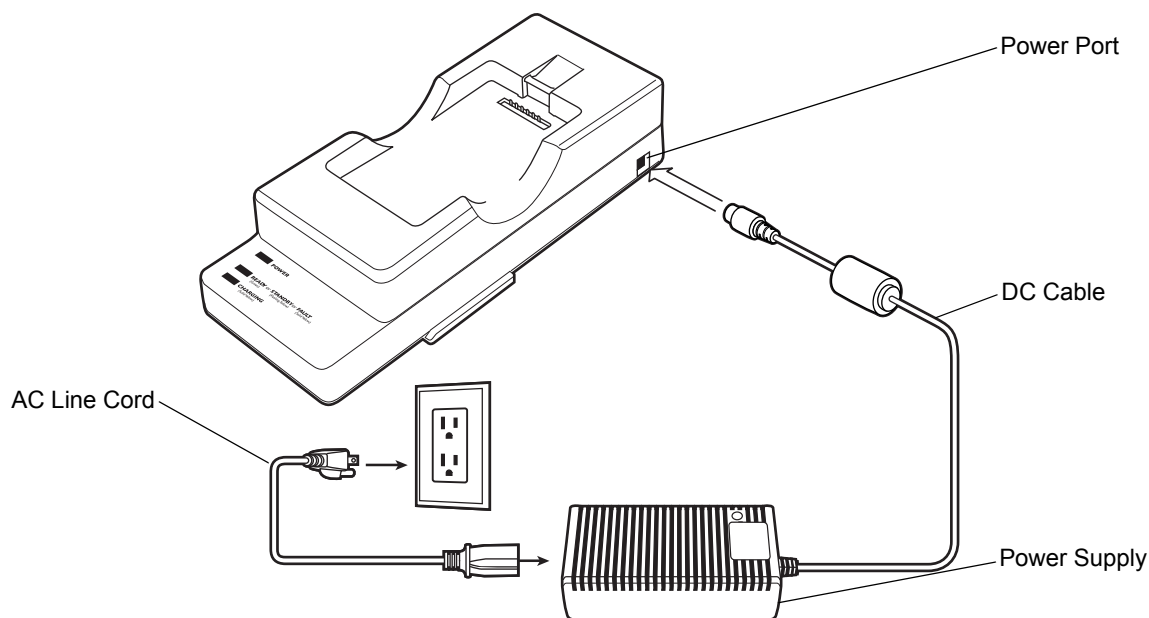

Figure 2-20 UBC Adapter Setup

Spare Battery Charging

To charge spare batteries:

1. Insert the spare battery into the spare battery charging slot, bottom first.
2. Pivot the top of the battery down onto the contact pins.

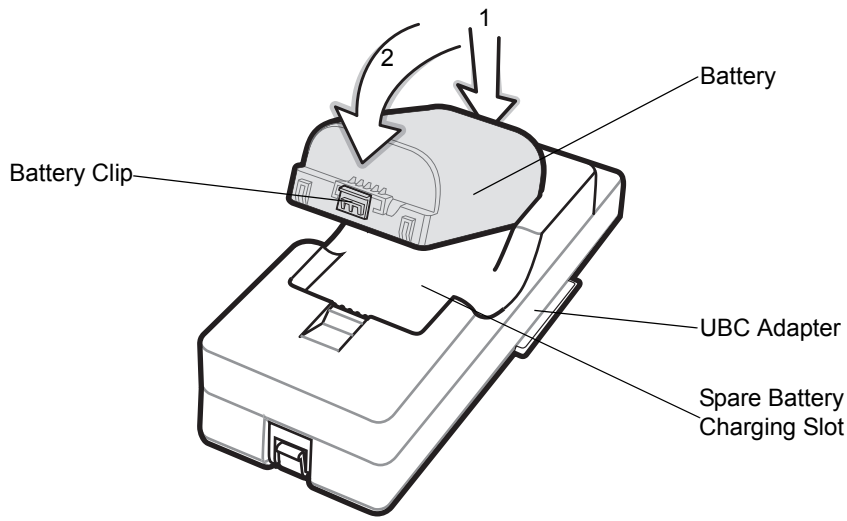

Figure 2-21 UBC Adapter Battery Insertion

3. Gently press down on the battery to ensure proper contact. The Standard Battery usually charges in less than five hours and the Extended Life Battery usually charges in less than eight hours. See [Table 2-3](#) for charging status indications.
4. When charging is complete, press the battery clip and lift the battery out of the slot.

UBC Adapter LED Charge Indications

The UBC Adapter charging LEDs indicate the battery charging status.

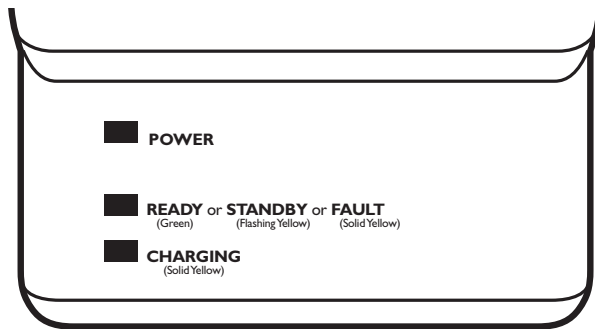

Figure 2-22 UBC Adapter LEDs

Table 2-3 UBC Adapter Charge LED Status Indications

LED	Indication	Description
POWER	Green	Power is connected to the UBC Adapter.
READY or	Green	Charging complete.

Table 2-3 *UBC Adapter Charge LED Status Indications*

LED	Indication	Description
STANDBY or	Flashing-Yellow	The battery was deeply discharged and is being trickle charged to bring the voltage up to the operating level. After operating level voltage is achieved, the battery charges normally.
FAULT	Yellow	Charging error, check placement of mobile computer/spare battery.
CHARGING	Yellow	Normal charge.

Serial/USB Communication

This section provides information on installing the appropriate serial/USB communication software and setting up the appropriate accessory to enable serial/USB communication between the mobile computer and the host device.

The mobile computer is capable of communicating with a number of hosts, including development computers, serial devices, printers, etc. The communication accessories serve as data communication devices, enabling the information on the mobile computer to be synchronized with the information on the host device using ActiveSync. With the appropriate accessory and software, the mobile computer can establish a serial connection or a USB connection.

For a serial or USB connection, use one of the following:

- Single Slot Serial/USB cradle
- MC31XX Communication/Charge cables.

Installing Serial/USB Communication Software

To successfully communicate with various host devices communication software, such as Microsoft ActiveSync (version 4.5 or higher) must be installed on the host computer. See [Chapter 3, ActiveSync](#) for ActiveSync installation procedures.

Chapter 3 ActiveSync

Introduction

To communicate with various host devices, install Microsoft ActiveSync (version 4.5 or higher) on the host computer. Use ActiveSync to synchronize information on the mobile computer with information on the host computer. Changes made on the mobile computer or host computer appear in both places after synchronization.

- ✓ **NOTE** When a mobile computer with Windows Mobile 6.1 is connected to a host computer and an ActiveSync connection is made, the WLAN radios (if applicable) are disabled. This is a Microsoft security feature to prevent connection to two networks at the same time.

ActiveSync software:

- Allows working with mobile computer-compatible host applications on the host computer. ActiveSync replicates data from the mobile computer so the host application can view, enter, and modify data on the mobile computer.
- Synchronizes files between the mobile computer and host computer, converting the files to the correct format.
- Backs up the data stored on the mobile computer. Synchronization is a one-step procedure that ensures the data is always safe and up-to-date.
- Copies (rather than synchronizes) files between the mobile computer and host computer.
- Controls when synchronization occurs by selecting a synchronization mode, e.g., set to synchronize continually while the mobile computer is connected to the host computer, or set to only synchronize on command.
- Selects the types of information to synchronize and control how much data is synchronized.

Installing ActiveSync

To install ActiveSync on the host computer, download version 4.5 or higher from the Microsoft web site at <http://www.microsoft.com>. Refer to the installation included with the ActiveSync software.

Mobile Computer Setup

✓ **NOTE** Microsoft recommends installing ActiveSync on the host computer before connecting the mobile computer.

The mobile computer can be set up to communicate with a USB connection. [Chapter 2, Accessories](#) provides the accessory setup and cable connection information for use with the mobile computer. The mobile computer communication settings must be set to match the communication settings used with ActiveSync.

On Windows CE 6.0 Devices:

1. On the mobile computer tap **Start > Settings > Control Panel > PC Connection** icon. The **PC Connection Properties** window appears.

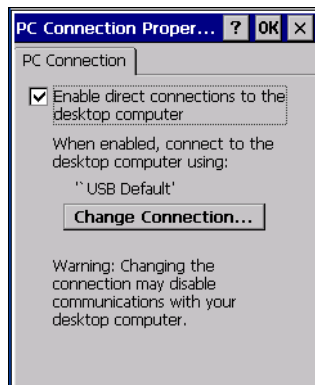

Figure 3-1 PC Connection Properties Window

2. Tap the **Change Connection** button.
3. Select the connection type from the drop-down list.
4. Tap **OK** to exit the **Change Connection** window and tap **OK** to exit the **PC Connection Properties** window.
5. Proceed with installing ActiveSync on the host computer and setting up a partnership.

On Windows Mobile 6.1 Devices:

1. On the mobile computer tap **Start > Programs > ActiveSync** icon. The **ActiveSync** window appears.

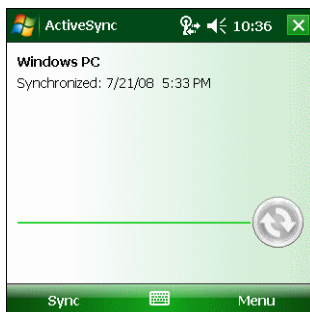

Figure 3-2 ActiveSync Window

2. Tap **Menu > Connections**.
3. Select the connection type from the drop-down list.

4. Tap **OK** to exit the **Connections** window and tap **OK** to exit the **ActiveSync** window.
5. Proceed with installing ActiveSync on the host computer and setting up a partnership.

Setting Up an ActiveSync Connection on the Host Computer

To start ActiveSync:

1. Select **Start > Programs > Microsoft ActiveSync** on the host computer. The **ActiveSync** Window displays.

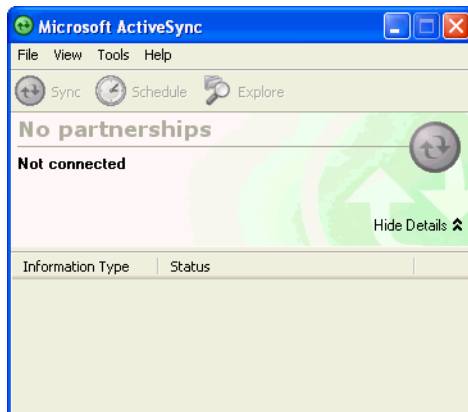

Figure 3-3 ActiveSync Window

- ✓ **NOTE** Assign each mobile computer a unique device name. Do not try to synchronize more than one mobile computer to the same name.

2. In the **ActiveSync** window, select **File > Connection Settings**. The **Connection Settings** window appears.



Figure 3-4 Connection Settings Window

3. Select the appropriate check box for the type of connection used.
4. Select the **Show status icon in Taskbar** check box.
5. Select **OK** to save any changes made.

Setting up a Partnership with a Windows CE 6.0 Device

To set up a partnership with a Windows CE 6.0 device:

1. If the **Get Connected** window does not appear on the host computer, select **Start > All Programs > Microsoft ActiveSync**.

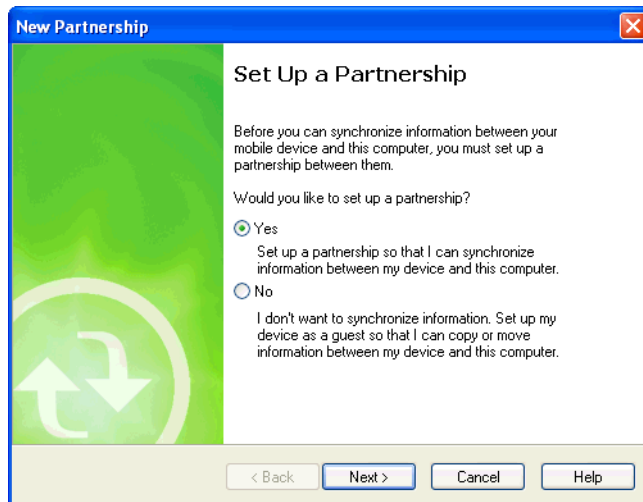

Figure 3-5 *New Partnership Window*

2. Select if you want to create synchronize with the host computer or to connect as a guest.
3. Click **Next**.

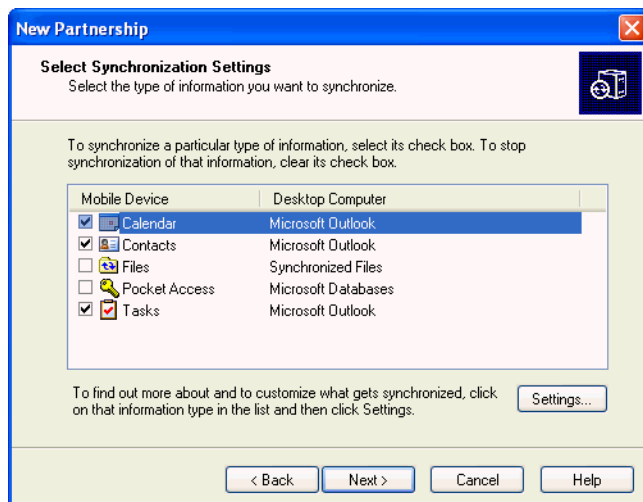

Figure 3-6 *Select Synchronization Setting Window*

4. Select the appropriate settings and click **Next**.

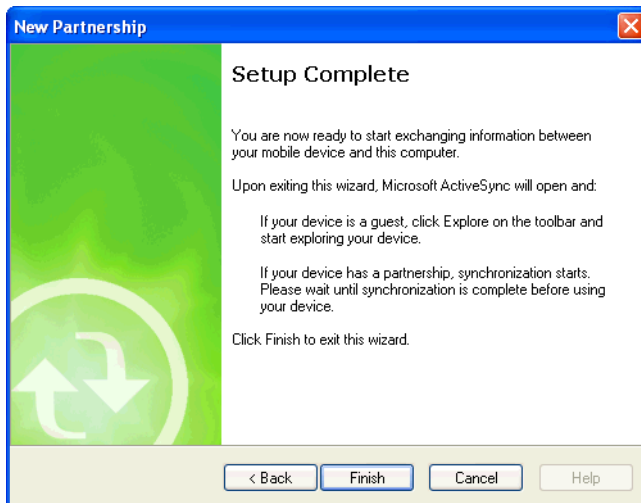

Figure 3-7 Setup Complete Window

5. Click **Finish**.

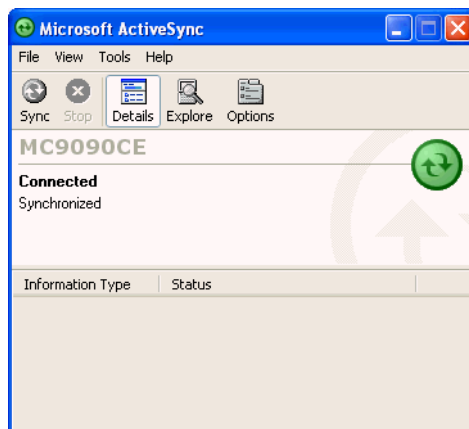

Figure 3-8 ActiveSync Connected Window

During the first synchronization, information stored on the mobile computer is copied to the host computer. When the copy is complete and all data is synchronized, the mobile computer can be disconnect from the host computer.

- ✓ **NOTE** The first ActiveSync operation must be performed with a local, direct connection. To retain partnerships after a cold boot, capture partnership registry information in a .reg file and save it in the Flash File System, detailed information is provided in the EMDK Windows CE Help File for Zebra Mobile Computers.

For more information about using ActiveSync, start ActiveSync on the host computer, then see ActiveSync Help.

Synchronization with a Windows Mobile 6.1 Device

- ✓ **NOTE** When a mobile computer with Windows Mobile 6.1 is connected to a host computer and an ActiveSync connection is made, the WLAN and WWAN radios (if applicable) are disabled. This is a Microsoft security feature to prevent connection to two networks at the same time.

To synchronize with a Windows Mobile 6.1 device:

1. If the **Get Connected** window does not appear on the host computer, select **Start > All Programs > Microsoft ActiveSync**.

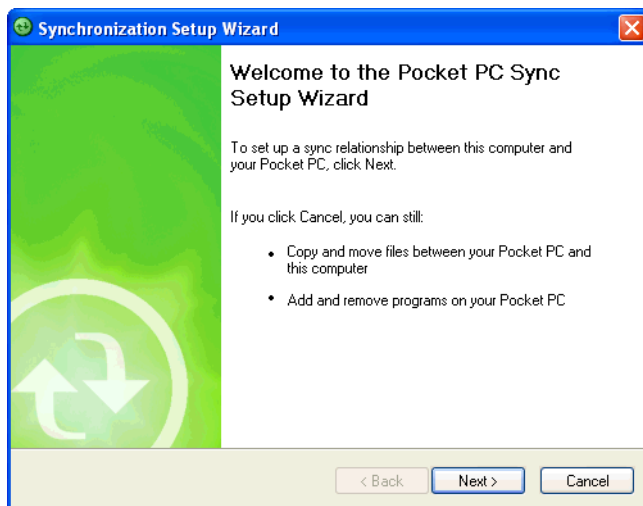

Figure 3-9 Synchronization Setup Wizard Window

2. Click **Next**.

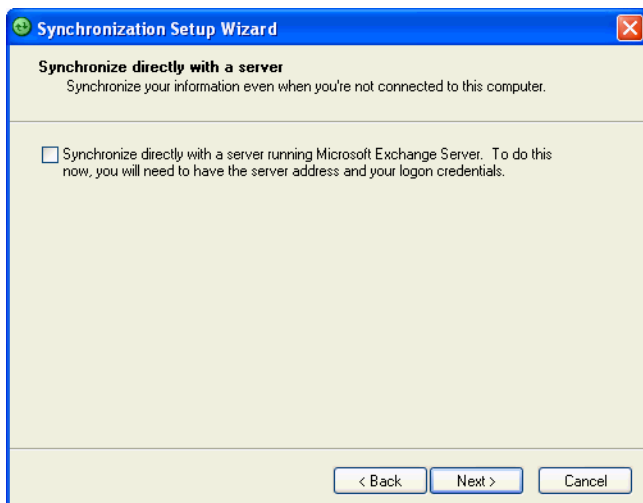

Figure 3-10 Synchronization Directly With a Server Window

3. Select the check box to synchronize with a server running Microsoft Exchange.
4. Click **Next**.

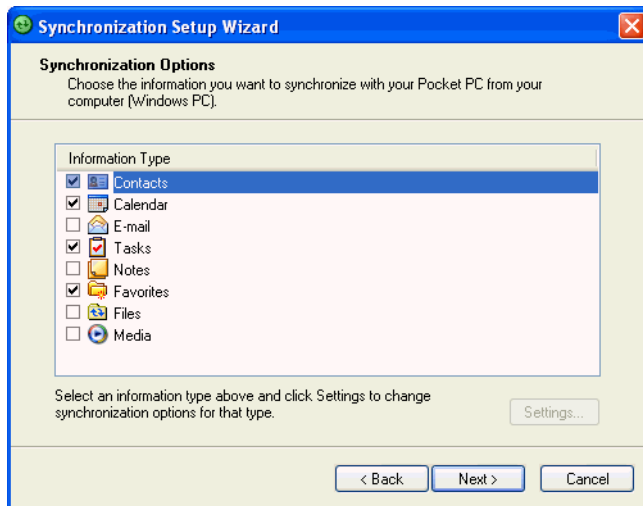

Figure 3-11 *Synchronization Option Window*

5. Select the appropriate settings and click **Next**.

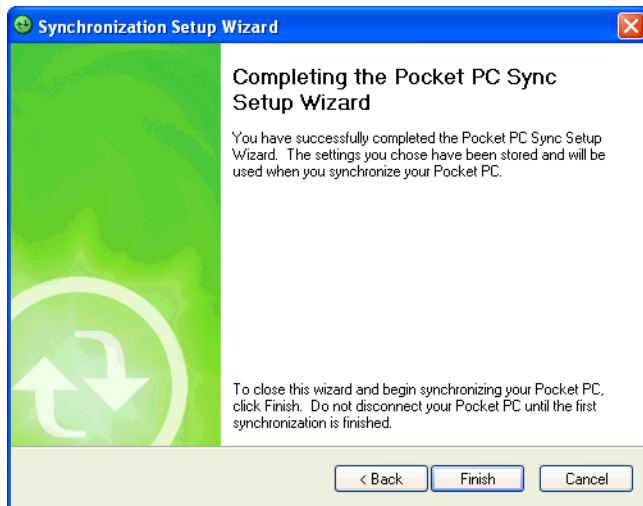

Figure 3-12 *Wizard Complete Window*

6. Click **Finish**.

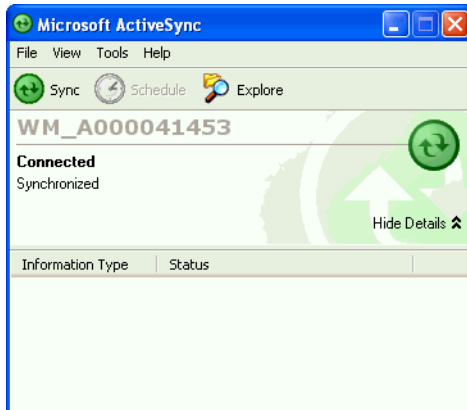

Figure 3-13 ActiveSync Connected Window

During the first synchronization, information stored on the mobile computer is copied to the host computer. When the copy is complete and all data is synchronized, the mobile computer can be disconnected from the host computer.

- ✓ **NOTE** The first ActiveSync operation must be performed with a local, direct connection. Windows Mobile retains partnerships information after a cold boot.

For more information about using ActiveSync, start ActiveSync on the host computer, then see ActiveSync Help.

Chapter 4 Application Deployment for Windows CE

Introduction

This chapter describes new features in Windows CE 6.0 including how to package applications, and procedures for deploying applications onto the MC31XX.

Application Design Considerations

To ensure application compatibility of a 320 x 320 display in Windows Mobile, some applications will need to be recompiled with the Microsoft WM6 SDK.

Packaging

Packaging combines an application's executable files into a single file, called a package. This makes it easier to deploy and install an application to the MC31XX. Package new applications and updates, such as new DLL files, as CAB files, then deploy them to the MC31XX. Refer to the *Microsoft Windows Mobile 6 Help* file for information on CAB files.

Software Installation on Development PC

To develop applications to run on the mobile computer, use one or both of the following:

- Developer Kit (EMDK) for C
- Platform Software Developer Kit (Platform SDK) for MC3100

The EMDK for C is a development tool used to create native C and C++ applications for all Zebra mobile computers. It includes documentation, header files (.H), and library files (.LIB) for native code application development that targets Zebra value-add APIs.

The *Windows CE Platform SDK for MC3100c60* is used in conjunction with the EMDK for C to create Windows CE applications for the MC31XX. The Platform SDK installs a new Windows CE device type and its associated libraries onto the development PC.

The software requirements to use the EMDK for C are:

- Microsoft Windows XP 32-bit Edition or Microsoft Windows Vista 32-bit Edition
- Microsoft ActiveSync 4.5 or higher. (only for Windows XP, Windows Vista has its own Mobile Device Center)
- If developing applications for Windows Mobile 6.X or Windows CE 6.0
 - Microsoft® Visual Studio 2005
 - Microsoft® Visual Studio 2005 Service Pack1
- (or)
- Microsoft® Visual Studio 2008
- Microsoft® Visual Studio 2008 Service Pack1
- One or more of the following Platform SDK's:
 - Windows Mobile 6 Professional and Standard Software Development Kits Refresh
- For Windows CE embedded development use the Zebra Platform SDK (PSDK) for your specific device. The PSDK can be found on the device download page at <http://www.zebra.com/support>

Platform SDK



NOTE Platform SDK is only required for Window CE 6.0 devices.

To download and install the appropriate Platform SDK:

1. Download the appropriate Platform SDK from the Support Central web site, <http://www.zebra.com/support>.
 - a. Select *Mobile Computers*. The *Mobile Computer Products* page displays.
 - b. Select *MC3100*. The *MC3100 Product* page displays.
 - c. On the *MC3100 Product* page, select the appropriate *Platform SDK for MC3100* from the *Software Downloads* section. The *Platform SDK* page displays.
 - d. Save the .exe file to the development computer.
2. Run the file and follow the screen prompts to install.

EMDK for C

To download and install the EMDK for C:

1. Download the EMDK from the Support Central web site, <http://www.zebra.com/support>.
 - a. Select *Mobile Computers*. The *Mobile Computer Products* page displays.
 - b. Select *MC3100*. The *MC3100 Product* page displays.
 - c. On the *MC3100 Product* page, select the appropriate *Developer Kit for C* from the *Software Downloads* section. The *Developer Kit for C* page displays.
 - d. Select the latest version, and save the .exe file to the development computer.
2. Locate the .exe file on the development computer, double-click the executable file and follow the install screen prompts.
3. Once installed, access the components of the EMDK for C from the *Developer Kit for C* program group of the *Windows Start* menu.

4. The sample applications provide examples of how to interface with the Zebra API functions. To build a sample application, open the Samples folder from the Windows *Start* menu. Open the folder for the desired sample and then open the project file. The project file has an extension of VCP. Microsoft Visual C++ v4.0 automatically launches. Select *WinCE* as the Active WCE Configuration. Select Win32 (WCE ARMV4) Debug as the active configuration.

✓ **NOTE** If both Microsoft Visual C++ v3.0 and Microsoft Visual C++ v4.0 are installed on the development computer, ensure Microsoft Visual C++ v4.0 launches.

Installing Other Development Software

Developing applications for the mobile computer may require installing other development software, such as application development environments, on the development PC. Follow the installation instructions provided with the software.

Software Updates

Download updates to the EMDK for C from the Support Central web site at: <http://www.zebra.com/support>. Check this site periodically for important updates and new software versions.

Windows CE Flash Storage

In addition to the RAM-based storage standard on Windows CE mobile computers, the MC31XX is also equipped with a non-volatile Flash-based storage area which can store data (partitions) that can not be corrupted by a cold boot. This Flash area is divided into two categories: Flash File System (FFS) Partitions and Non-FFS Partitions.

FFS Partitions

The MC31XX includes two FFS partitions. These partitions appear to the mobile computer as a hard drive that the OS file system can write files to and read files from. Data is retained even if power is removed.

The two FFS partitions appear as two separate folders in the Windows CE file system and are as follows:

- Platform: The Platform FFS partition contains Zebra-supplied programs and Dynamic Link Libraries (DLLs). This FFS is configured to include DLLs that control system operation. Since these drivers are required for basic mobile computer operation, only experienced users should modify the content of this partition.
- Application: The Application FFS partition is used to store application programs needed to operate the mobile computer.

Working with FFS Partitions

Because the FFS partitions appear as folders under the Windows CE file system, they can be written to and read like any other folder. For example, an application program can write data to a file located in the Application folder just as it would to the Windows folder. However, the file in the Application folder is in non-volatile storage and is not lost on a cold boot (e.g., when power is removed for a long period of time).

Standard tools such as ActiveSync can be used to copy files to and from the FFS partitions. They appear as the "Application" and "Platform" folders to the ActiveSync explorer. This is useful when installing applications on the mobile computer. Applications stored in the Application folder are retained even when the mobile computer is cold booted, just as the Sample Applications program is retained in memory.

There are two device drivers included in the Windows CE image to assist developers in configuring the mobile computer following a cold boot: RegMerge and CopyFiles.

RegMerge.dll

RegMerge.dll is a built-in driver that allows registry edits to be made to the Windows CE registry. Regmerge.dll runs very early in the boot process and looks for registry files (.reg files) in certain Flash File System folders during a cold boot. It then merges the registry changes into the system registry located in RAM.

Since the registry is re-created on every cold boot from the default ROM image, the RegMerge driver is necessary to make registry modifications persistent over cold boots.

RegMerge is configured to look in the root of two specific folders for .reg files in the following order:

\Platform

\Application

Regmerge continues to look for .reg files in these folders until all folders are checked. This allows folders later in the list to override folders earlier in the list. This way, it is possible to override Registry changes made by the Platforms partitions folders. Take care when using Regmerge to make registry changes.

✓ **NOTE** Regmerge only merges the .reg files on cold boots. The merge process is skipped during a warm boot.

Making modifications to registry values for drivers loaded before RegMerge is not recommended. However, these values may require modification during software development. Since these early loading drivers read these keys before RegMerge gets a chance to change them, the mobile computer must be cold booted. The warm boot does not re-initialize the registry and the early loading driver reads the new registry values.

Do not use Regmerge to modify built-in driver registry values, or merge the same registry value to two files in the same folder, as the results are undefined.

CopyFiles

Windows CE expects certain files to be in the Windows folder, residing in volatile storage. Windows CE maintains the System Registry in volatile storage. CopyFiles copies files from one folder to another on a cold boot. Files can be copied from a non-volatile partition (Application or Platform) to the Windows or other volatile partition during a cold boot. During a cold boot CopyFiles looks for files with a .CPY extension in the root of the Platform and Application FFS partitions (Platform first and then Application). These files are text files containing the source and destination for the desired files to be copied separated by ">".

Files are copied to the Windows folder from the Flash File System using copy files (*.cpy) in the following order:

```
\Platform
\Application
```

Example:

```
\Application\ScanSamp2.exe>\Windows\ScanSamp2.exe
```

This line directs CopyFiles to copy the ScanSamp2.exe application from the \Application folder to the \Windows folder.

Non-FFS Partitions

Non-FFS partitions include additional software and data pre-loaded on the mobile computer that can be upgraded. Unlike FFS Partitions, these partitions are not visible when the operating system is running. They also contain system information. Non-FFS partitions include the following:

- Windows CE: The complete Windows CE operating system is stored on Flash devices. If necessary, the entire OS image may be downloaded to the mobile computer using files provided by Zebra. Any upgrades must be obtained from Zebra. This partition is mandatory for the mobile computer.
- Splash Screen: a bitmap smaller than 16 Kb (and limited to 16 bits per pixel) is displayed as the mobile computer cold boots. To download a customized screen to display, see *Creating a Splash Screen on page 4-17*.
- Bootloader: This program interfaces with the host computer and allows downloading via USB cable any or all of the partitions listed above, as well as updated versions of Bootloader. Use caution downloading updated Bootloader versions; incorrect downloading of a Bootloader causes permanent damage to the mobile computer. Bootloader is mandatory for the mobile computer.
- Partition Table: Identifies where each partition is loaded in the mobile computer.

Downloading Partitions to the Mobile Computer

USBDownload is used to specify a hex destination file for each partition and download each file to the mobile computer. This download requires a program loader stored on the mobile computer. The mobile computer comes with a program loading utility, Bootloader, stored in the mobile computer's write-protected flash.

Bootloader

Bootloader allows the user to upgrade the mobile computer with software updates and/or feature enhancements.

Partition Update vs. File Update

There are two types of updates supported by the mobile computer: partitions and files. The file system used by the mobile computer is the same as the file system used on a desktop computer. A file is a unit of data that can be accessed using a file name and a location in the file system. When a file is replaced, only the contents of the previous file are erased. The operating system must be running for a file to be updated, so the Bootloader cannot perform individual file updates as it is a stand-alone program that does not require the operating system to be running.

A typical partition is a group of files, combined into a single "partition" that represents a specific area of storage. Examples of partitions are the flash file systems such as Platform or Application. (Using the desktop computer comparison, these partitions are roughly equivalent to a C: or D: hard disk drive.) In addition to the "hard disk" partitions, some partitions are used for single items such as the operating system, monitor, or splash screen. (Again using a desktop computer comparison, these partitions are roughly the equivalent of the BIOS or special hidden system files.) When a partition is updated, all data that was previously in its storage region is erased - i.e. it is not a merge but rather a replacement operation. Typically, the operating system is not running when partitions are update, so Bootloader can perform partition updates.

All partition images suitable for use by Bootloader are in hex file format for transfer by USBDownloader from the development computer to the mobile computer.

Upgrade Requirements

Upgrade requirements:

- The hex files to be downloaded (on development computer)
- A connection from the host computer and the mobile computer
- USBDownload (on development computer) to download the files.

Once these requirements are satisfied, the mobile computer can be upgraded by invoking Bootloader and navigating the menus. See *Bootloader on page 4-10* for procedures on downloading a hex file to the mobile computer.

Deployment

This section provides information about installing software and files on the MC31XX.

Software deployment can be performed by:

- Copying files from a host computer
- Installing programs
- Updating images.

Copying Files from a Host Computer

To copy files from a host computer to the MC31XX:

1. Ensure that ActiveSync is installed on the host computer and that a partnership was created. For more information see, [Chapter 3, ActiveSync](#).
2. Connect the mobile computer to the host computer using a Single Slot Serial/USB cradle or an appropriate cable. See, [Chapter 2, Accessories](#) for connection information.
3. On the host computer, select **Start > Programs > ActiveSync**.

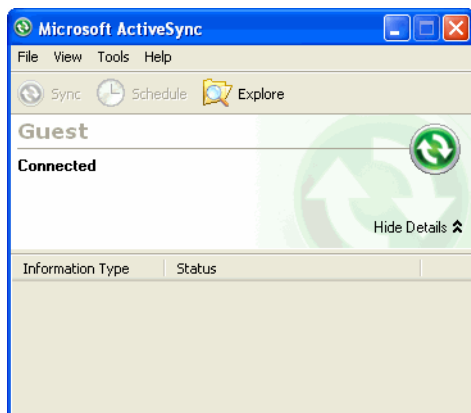

Figure 4-1 ActiveSync Connected Window

4. Select *Explore*.

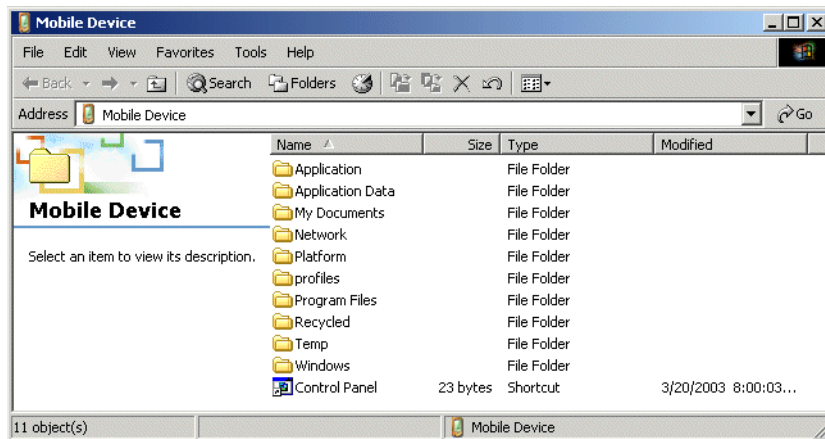

Figure 4-2 ActiveSync Explorer

5. Double-click the folder to expand the folder contents.

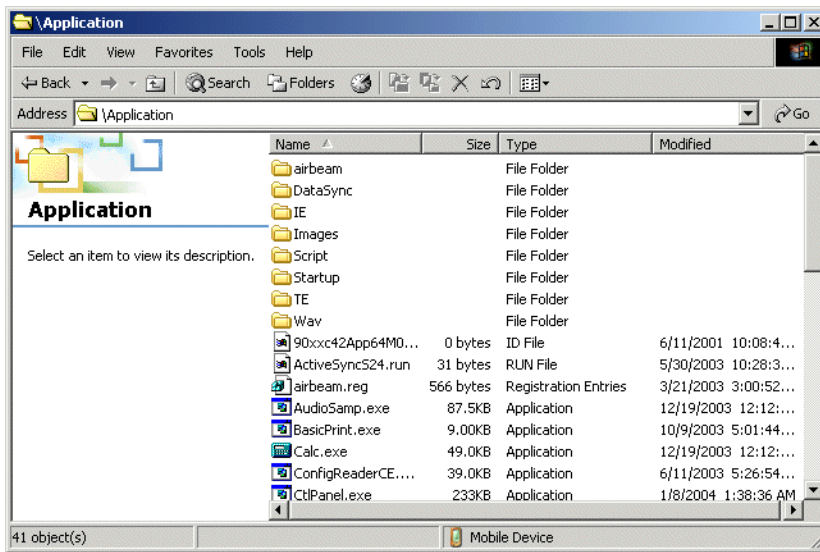

Figure 4-3 Application Folder Contents

- Use Explorer to locate the host computer directory that contains the file to download. Tap that directory in the left pane to display its contents in the right pane.
- Drag the desired file(s) from the host computer to the desired mobile device folder.

Adding Programs

Install the appropriate software on the host computer before installing it on the mobile computer:

- Download the program to the host computer (or insert the CD or disk that contains the program into the host computer). The program may consist of a single *.xip file, *.exe file, a *.zip file, or a Setup.exe file.
- Read any installation instructions, ReadMe files, or documentation that comes with the program. Many programs provide special installation instructions.
- Connect the mobile computer to the host computer using an accessory described in [Chapter 2, Accessories](#).
- Ensure that a connection is established.
- Double-click the executable file on the host computer.

If the file is an installer, the installation wizard begins. Follow the directions on the window. Once the software is installed on the host computer, the installer transfers the software to the mobile computer.

If the file is not an installer, an error message states that the program is valid but is designed for a different type of computer. Copy this file to the mobile computer. Follow the installation instructions for the program in the ReadMe file or documentation, or use ActiveSync Explore to copy the program file to the Program Files folder on the mobile computer as described in [Copying Files from a Host Computer on page 4-7](#). For more information on copying files using ActiveSync, refer to ActiveSync Help.

- When installation is complete, tap **Start > Programs** on the mobile computer, then tap the program icon.

Adding a Program from the Internet

- Download the program to the mobile computer from the Internet using **Internet Explorer**.

2. Read any installation instructions, Read Me files, or documentation that comes with the program. Many programs provide special installation instructions.
3. Tap the file, such as a .xip or .exe file, to launch the installation wizard. Follow the directions on the window.

Updating Images

The MC31XX contains tools that update all operating system components. All updates are distributed as packages and/or hex images. Update packages can contain either partial or complete updates for the operating system. Zebra distributes the update packages on the Support Central Web Site, <http://www.zebra.com/support>.

Update an operating system component using one of the following:

- MSP. See *Mobility Services Platform on page 4-16* for information.
- OS Update or BootLoader on Windows CE devices.

Windows CE 6.0 OSUpdate Loader

Bootloader using SD or USB

OSUpdate using SD Card or Temp directory

Operating system component can be downloaded to the MC31XX using the MC31XX temp directory or an SD card.

Using MC31XX Temp Directory

To initiate an update using the MC3100 temp directory:

1. Go to the Support Central web site, <http://www.zebra.com/support>.
2. Download the appropriate update package.
3. Connect the MC31XX to a host computer using the Single Slot Serial/USB Cradle or USB Communication Cable. See *Chapter 2, Accessories*.
4. Using ActiveSync, copy the update package to the \temp directory on the MC31XX.
5. Using Windows Explorer, navigate to the temp directory.
6. Open the OSUpdate folder.
7. Double tap on the file: 3100c60Ben_TEMP.Ink.
8. When the Update Loader application finds the appropriate file, it loads the package onto the MC31XX. A progress bar displays until the update completes.
9. When complete, the MC31XX re-boots.
10. The calibration screen appears.

Using SD Card

To initiate an update using the MC3100 temp directory:

1. Go to the Support Central web site, <http://www.zebra.com/support>.
2. Download the appropriate update package.

3. Copy the update package to the root directory of an SD card (using a host computer).
4. Remove the battery.
5. Install the SD card.
6. Replace the battery and battery door.
7. Connect the MC31XX to AC power. See [Chapter 2, Accessories](#).
8. Using Windows Explorer, navigate to the SD card folder.
9. Open the OSUpdate folder.
10. Double tap on the file: 3100c60Ben_SD.lnk
11. When the Update Loader application finds the appropriate file, it loads the package onto the MC31XX. A progress bar displays until the update completes.
12. When complete, the MC31XX re-boots.
13. The calibration screen appears.

Bootloader

Use Bootloader to download hex files to the MC31XX from an SD card or from a host computer via USB.

Loading Files From SD Card

To load the hex files on to the mobile computer using an SD card:

1. Copy the files to the root directory of an SD card.
2. Remove the battery.
3. Insert the SD card into the MC31XX.
4. Install the battery.
5. Simultaneously press the **Power** button and the **1** and **9** keys.
6. Immediately, as soon as the device starts to boot, press and hold the left scan button or trigger.
7. Continue to hold the scan button or trigger while releasing the **1**, **9** and **Power** keys until the Bootloader screen appears.
8. When the **Bootloader** screen appears, release the scan button or trigger.

```
Select required operation
Download from SD card
Download from USB
Exit

Bootloader 1.09.3010
```

Figure 4-4 *Bootloader Menu*



CAUTION To ensure a successful download, do not remove power from the mobile computer while in Bootloader.

1. Use the up and down scroll buttons to select **Download from SD card**, then press **Enter**.
2. The Bootloader displays the hex files available on the SD card.

```
a:\
All Done
3100c60XenMO06109xx.hex
3100c60XenMO06109xx.hex
3100c60XenMO06109xx.hex
3100c60XenMO06109xx.hex
3100c60XenMO06109xx.hex

Bootloader 1.09.3010
```

Figure 4-5 *Hex File List*

1. Use the up and down scroll buttons to select a hex file, then press **Enter**.
2. The hex file is downloaded to the device.

```

Splash screen
#### (20)      100%
Download complete
in - 0.042 seconds
(1854142 bytes/second)

Hit Enter to Acknowledge

Bootloader 1.09.3010

```

Figure 4-6 *Download Complete Screen*

3. On completion, press **ENT** to return to the Bootloader menu to select the next file to download.
4. To exit Bootloader, select **Exit** from the Bootloader main screen and press **ENT**.

Loading Files via USB

Use Bootloader to download customized flash file system partitions to the mobile computer and load hex files to the flash memory of the mobile computer.

To load the hex files on to the mobile computer using USB:

1. Download the USBDownload application from the Support Central web site. Follow the installation instructions with the application.
2. Connect the MC31XX to a host computer using the Single Slot Serial/USB Cradle or USB Cradle Cable.
3. On the host computer, launch the USBDownload application.

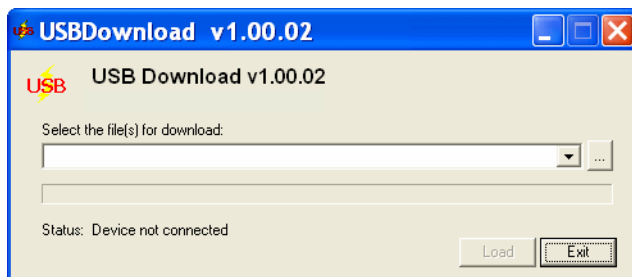

Figure 4-7 *USB Download Window*

4. Simultaneously press the **Power** button and the **1** and **9** keys.
5. Immediately, as soon as the device starts to boot, press and hold the left scan button or trigger.
6. Continue to hold the scan button or trigger while releasing the **1**, **9** and **Power** keys until the Bootloader screen appears.
7. When the **Bootloader** screen appears, release the scan button or trigger.

```

Select required operation
Download from SD card
Download from USB
Exit

Bootloader 1.09.3010

```

Figure 4-8 *Bootloader Menu*



CAUTION To ensure a successful download, do not remove power from the mobile computer while in Bootloader.

1. Use the up and down scroll buttons to select **Download from USB**, then press **ENT**.
2. The Bootloader displays the following:

```

Waiting for input. . .

Bootloader 1.09.3010

```

Figure 4-9 *Waiting for Input*

1. On the host computer, locate the hex files to download.



NOTE One hex file or multiple hex files can be selected. To select multiple files, press the **Ctrl** key while selecting files.

If selecting multiple files to download, USBDownload reads the header of the file and identifies the file type. If the Partition table file is among the files selected, then USBDownload downloads that file first. Similarly, USBDownload downloads the CPLD file last.

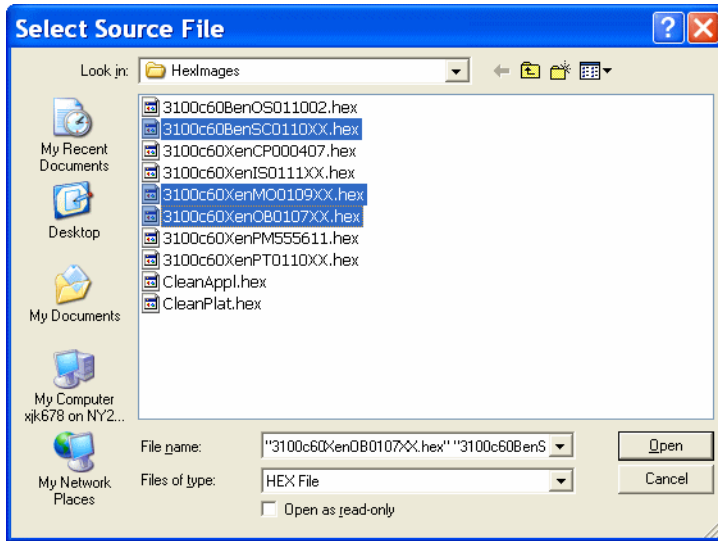

Figure 4-10 Select Source File Window

2. Select the hex files and the click **Open**.

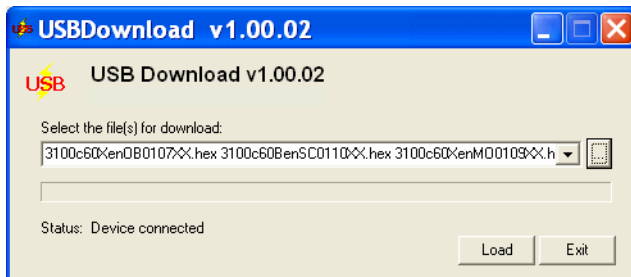

Figure 4-11 Select Hex File(s)

3. Click the **LOAD** button. The hex file(s) is downloaded to the device.

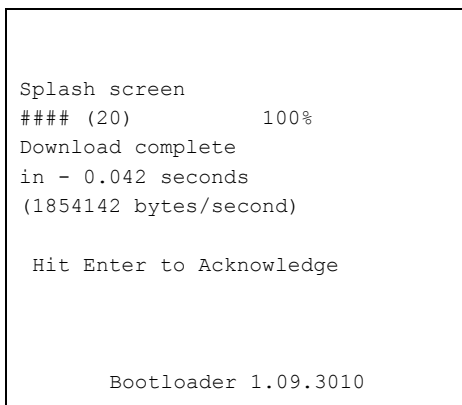

Figure 4-12 Download Complete Screen

4. On completion, press **ENT** to return to the Bootloader main screen to select the next file to download.
5. To exit Bootloader, select **Exit** from the Bootloader main screen and press **ENT**.

Bootloader Error Detection

While receiving data, Bootloader performs many checks on the data to ensure that the data is received correctly. If an error is detected, Bootloader immediately aborts the download, and reports the error on an error screen.

This error message screen displays until a key is pressed. Once the screen is acknowledged, Bootloader returns to the main menu to wait for a new selection.

To find the probable cause of the error, use the error number and/or the error text displayed on the screen to look up the error in [Table 4-1](#).

Table 4-1 *Bootloader Errors*

Error Text	Error Number	Probable Cause
Unknown error	-1	A general error occurred. Retry the download. If the failure persists, it is most likely due to a hardware failure; the mobile computer requires servicing.
Cancelled by user	-2	The user cancelled the download.
Can't open the source	-7	An error occurred opening the source device (either USB or SDMMC). Check source device connectivity and retry.
Can't open the destination	-8	An error occurred opening the destination device (either NAND, RAM, Power Micro, IST, Keyboard Controller or CPLD). Retry the download. If the failure persists, it is most likely due to a hardware failure; the mobile computer requires servicing.
Can't read from the source device	-9	The source device (either USB or SDMMC) could not be read from. Check source device connectivity and retry.
Can't write to the destination device	-10	The destination device (either NAND, RAM, Power Micro, IST, Keyboard Controller or CPLD) could not be written to. Retry the download. If the failure persists, it is most likely due to a hardware failure; the mobile computer requires servicing.
Transmission checksum error	-11	An error occurred during transmission from the source device (either USB or SDMMC) and the checksum check failed. Check source device connectivity and retry.
Readback checksum error	-12	A checksum, generated from reading back data that was written to the destination device, was incorrect. An error during transmission or a write error to the destination device could cause this.
There is no more heap space available	-14	There is no more heap space available for the download procedure. Restart Bootloader and retry the download. If the failure persists, contact service with details of what is being downloaded.
Invalid data in verify file	-19	The file contains invalid data. Check that the file is suitable for downloading on this terminal.
Insufficient memory for buffering data	-20	There is no more heap space available for the download procedure. Restart Bootloader and retry the download. If the failure persists, contact service with details of what is being downloaded.

Table 4-1 *Bootloader Errors (Continued)*

Error Text	Error Number	Probable Cause
Insufficient data available to complete record	-21	A HEX file download was attempted but the HEX file is invalid. Ensure the file is in proper HEX file format.
Invalid Symbol HEX file	-23	A HEX file download was attempted but the HEX file is invalid. Ensure the file is in proper HEX file format.
Unrecognized or unsupported HEX record	-24	The HEX file being downloaded contains an invalid or unrecognized HEX record. Ensure the file is in proper HEX file format.
Invalid data in HEX file	-25	The HEX file being downloaded contains invalid data. Ensure the file is in proper HEX file format with valid HEX data.
Exceeded max size	-26	The download file is too large to fit into the space allocated for it. Either make the file smaller or increase the space allocated for it by altering the partition table.
Partition is not valid on this device	-27	The downloaded file specifies a partition entry that does not exist on the device. Only download files that are valid for this device, or change the partition table so that the new file is valid on the device.
Wrong destination code	-28	A specific partition was chosen from the <i>Bootloader</i> main menu but the file selected for download was for another partition. Ensure that the partition selected from the <i>Bootloader</i> main menu matches the file selected for download.
Non-contiguous record found	-30	A HEX file download was attempted but the HEX file is invalid. Ensure the file is in proper HEX file format.
Timed Out - No data	-31	Bootloader was waiting for data from the source device but timed out before receiving any. Check the source device connectivity and retry.
Invalid file format	-33	The file format is invalid. Only HEX files are supported by Bootloader.
Partition Table not Valid	-34	The size of flash memory is different than that described in the partition table. Retry the download with the correct partition table file.
Invalid data in file	-35	The .bin or .sig file being downloaded contains invalid data. Ensure the file is in proper file format.
File cannot be loaded to this unit	-38	The file contains valid data that indicates it cannot be loaded onto the device.
File validation failed	-40	The file has either been signed incorrectly, or contains data that indicates that it cannot be loaded onto the terminal.

Mobility Services Platform

The MSP 3 Client Software is a set of software components that come pre-installed on the MC31XX. The MSP 3 Client software consists of the following components:

The RD Client provides support for MSP 3 Staging functionality, provides support for the MSP 3 Legacy Staging process, and provides support for backward-compatible legacy MSP 2.x Legacy Staging functionality.

The MSP 3 Agent provides MSP 3 Provisioning functionality and Control functionality when used with MSP 3.2 Control Edition.

Refer to the *Mobility Services Platform 3.2 User's Guide*, p/n 72E-100158-06, for instructions for using the Rapid Deployment and MSP3 Agent clients.

Creating a Splash Screen

A custom splash screen can be created and loaded onto the MC31XX. To create a custom splash screen:

1. Create a .bmp file using a graphic program with the following specifications:
 - Size: 320 (W) x 240 (H).
 - Colors: 256.
2. Modify the bitmap file and save.

To load the splash screen on the MC31XX Windows CE device:

1. Convert the bmp file into a hex file using the OSUpdate Package Builder that is part of MSP.
2. Copy the hex file to the MC31XX using BootLoader. See [Bootloader on page 4-10](#).

Chapter 5 Application Deployment for Windows Mobile

Introduction

This chapter describes new features in Windows Mobile 6.1 including new security features, how to package applications, and procedures for deploying applications onto the MC31XX.

Application Design Considerations

To ensure application compatibility of a 320 x 320 display in Windows Mobile, some applications will need to be recompiled with the Microsoft WM6 SDK.

Security

The MC31XX implement a set of security policies that determine whether an application is allowed to run and, if allowed, with what level of trust. To develop an application, you must know the security configuration of the device, and how to sign an application with the appropriate certificate to allow the application to run (and to run with the needed level of trust).

Application Security

Application security controls the applications that can run on the MC31XX.

- Trusted - All applications must be digitally signed by a certificate on the MC31XX.
- Prompted - User is prompted to allow unsigned applications to run.
- Open - All applications run.

Developers can include their own certificates and provision the device to “trusted.”

Digital Signatures

Digital signatures provide a way to authenticate the author of EXEs, DLLs, and packages. Digitally signed applications give users confidence that an application comes from where they think it comes from. For example, if an end-user downloads an update package from the internet that is digitally signed with Zebra's software

certificate, they are assured that the package is authentic and that it was created by Zebra. By enforcing the use of digital signatures, users can also prevent malicious applications from executing on the MC31XX. For example, users can provision the MC31XX to only execute “trusted” applications (digitally signed).

Zebra ships all Windows Mobile 6.1 based products in an “open” state, which means all signed and unsigned applications should work. However, customers can still reconfigure their MC31XXs to operate in the “trusted” mode. This means that only applications signed with a certificate from the Privileged Execution Trust Certificate Store can run.

To support the broadest number of deployments, third-party software developers should perform the following when releasing software for a Windows Mobile 6.1 devices:

- Sign all their EXEs & DLLs with their private key
- Provide the corresponding public certificate to end-users so that it can be installed into Privileged Execution Trust Certificate Store.

If the software is installed via a .CAB file, developer should also:

- Sign the .CAB file with their private key
- Provide the corresponding public certificate to end-users so that it can be installed into SPC Certificate Store.

Locking Down a Mobile Computer

Like most configuration options in Windows Mobile 6.1, security settings are set via XML provisioning. For example, to enforce the “trusted” model and only allow applications signed with a privileged certificate to run, use the following provisioning document:

```
<wap-provisioningdoc>
  <characteristic type="SecurityPolicy">
    <!-- Disallow unsigned apps -->
    <parm name="4102" value="0"/>

    <!-- No Prompt -->
    <parm name="4122" value="1"/>
  </characteristic>
</wap-provisioningdoc>
```

For more information on various security options, refer to the Security Policy Settings topic in the latest Windows Mobile documentation.

Installing Certificates

Use XML provisioning to query and delete certificates from certificate stores. To add a new certificate the Privileged Execution Trust Certificate Store, use the following sample provisioning document:

```
<wap-provisioningdoc>
<characteristic type= "CertificateStore">
<characteristic type= "Privileged Execution Trust Authorities">
<characteristic type= "657141E12FA45786F6A57CA6464032D4B3A55475">
<parm name= "EncodedCertificate" value= "
This is sample text. This is sample text. This is sample text. This is sample text.
This is sample text. This is sample text. This is sample text. This is sample text.
This is sample text. This is sample text. This is sample text. This is sample text. = "/>
</characteristic>
</characteristic>
</characteristic>
</wap-provisioningdoc>
```

To create your own provisioning document with real certificate information:

1. Obtain a certificate from a security provider such as VeriSign.
2. Double-click on the certificate file (.CER) to open it.
3. Click on the *Details* tab and locate the *Thumbprint* field.
4. Copy the contents of the *Thumbprint* field and replace the value in the XML example above.
5. Click the **Copy to File...** button.
6. Click **Next** to start the Certificate Export Wizard.
7. Select *Base-64 encoded X.509 (.CER)* and then click **Next**.
8. Set the File Name to CertOutput.xml and click **Next**.
9. Click **Finish** to export the certificate.
10. Open the exported file, CertOutput.xml, in a text editor (i.e., NotePad).
11. Copy the contents of the file (excluding the first line, last line, and CR/LF) and replace the value of the *"EncodedCertificate"* parameter in the xml example above.

Device Management Security

You can control access to certain device settings and security levels, such as installing applications and changing security settings. Refer to the *Windows Mobile Version 6 Help* file for information on device management security.

Remote API Security

The Remote API (RAPI) enables applications that run on a desktop to perform actions on a remote device. RAPI provides the ability to manipulate the file system on the remote device, including the creation and deletion of files and directories. By default, Zebra ships with RAPI in the restricted mode. Certain tools, such as RAPIConfig, may

not work properly. Refer to the *Windows Mobile Version 6 Help* file for finding information on Remote API security policies.

XML Provisioning

To configure the settings on an MC31XX, use XML provisioning. To install an XML provisioning file on the MC31XX, create a Cabinet Provisioning File (CPF). A CPF file is similar to a CAB file and contains just one file: `_setup.xml`. Like a CAB file, the CPF extension is associated with `WCEload.EXE`. Opening a CPF extracts the XML code and uses it to provision and configure the MC31XX. The user receives an e-mail notification indicating success or failure.

XML provisioning provides the ability to configure various features of the MC31XX (i.e., registry and file system). However, some settings require security privileges. To change registry settings via a CPF file, you must have certain privileges (roles). Some registry keys require you to simply be an *Authenticated User*, while other registry keys require you to be a *Manager*. Refer to the *Microsoft Windows Mobile 6 Help* file, *Metabase Settings for Registry Configuration Service Provider* section, for the default role settings in Windows Mobile 6.1.

For those registry settings that require the *Manager* role, the CPF file must be signed with a privileged certificate installed on the device. Refer to the *Microsoft Windows Mobile 6 Help* file and the *Windows Mobile 6 SDK* for instructions and sample test certificates.

Creating an XML Provisioning File

To create a `.cpf` file:

1. Create a valid provisioning XML file named `_setup.xml` using an XML editor or the tools supplied with Visual Studio 2005. (For example, use the `SampleReg.xml` sample created in the *RegMerge* section and rename it `_setup.xml`.) Ensure the file contains the required parameters for the operation. Refer to the *Microsoft Windows Mobile 6 Help* file for information.
2. In the Windows Mobile 6.1 tools directory on the desktop computer (typically `\Program Files\Windows CE Tools\wce500\Windows Mobile 6 Pocket PC SDK\Tools`), run the `Makecab.exe` utility, using the following syntax to create a `.cpf` file from the `_setup.xml` file:

```
MakeCab.exe /D COMPRESS=OFF _setup.xml myOutCpf
```

✓ **NOTE** COMPRESS=OFF is required for backward compatibility with Pocket PC.

3. Optionally, use the `Authenticode` tools to sign the `.cpf` file.
4. Tap the filename to install.
5. Certain applications and settings require a cold boot to take affect. In these cases, cold boot the MC31XX. Refer to the *Windows Mobile Version 6 Help* file for more information.

XML Provisioning vs. RegMerge and Copy File

Prior to Windows Mobile 6.1, Zebra used two drivers (`RegMerge` and `CopyFiles`) to update the registry and to copy files during a cold boot. With Mobile 6.1, Zebra recommends using XML provisioning instead. `RegMerge` and `CopyFiles` are supported for backward compatibility but Zebra may eliminate support in the future. The following sections provide examples of how `RegMerge` and `CopyFiles` were used, and how to perform the same function using XML provisioning.

RegMerge

RegMerge.dll is a built-in driver that allows updating the registry during a clean boot. RegMerge runs very early in the boot process and looks for registry files (.reg files) in certain Flash File System folders (i.e., \Application) during a clean boot. It then merges the registry changes into the system registry located in RAM.

The following example uses RegMerge to set a registry key:

SampleReg.reg

```
[HKEY_LOCAL_MACHINE\Hardware\DeviceMap\Backlight]
"BacklightIntensity"=dword:00000036
```

The following example uses XML provisioning to perform the same task:

SampleReg.xml

```
<wap-provisioningdoc>
  <characteristic type= "Registry">
    <characteristic type= "HKLM\Hardware\DeviceMap\Backlight">
      <parm name= "BacklightIntensity" value= "54" datatype= "integer" />
    </characteristic>
  </characteristic>
</wap-provisioningdoc>
```

CopyFiles

CopyFiles copies files from one folder to another on a clean boot. During a clean boot CopyFiles looks for files with a .CPY extension in the root of the Application FFS partition. These files are text files containing the source and destination for the desired files to copy, separated by ">".

The following example uses CopyFiles to copy a file from the \Application folder to the \Windows folder:

SampleCpy.cpy

```
\Application\example.txt > \Windows\example.txt
```

The following example uses XML provisioning to perform the same task:

SampleCpy.xml

```
<wap-provisioningdoc>
  <characteristic type= "FileOperation">
    <characteristic type= "\Windows" translation= "filesystem">
      <characteristic type= "MakeDir"/>
      <characteristic type= "example.txt" translation= "filesystem">
        <characteristic type= "Copy">
          <parm name= "Source" value= "\Application\example.txt" translation= "filesystem"/>
        </characteristic>
      </characteristic>
    </characteristic>
  </characteristic>
</wap-provisioningdoc>
```

Packaging

Packaging combines an application's executable files into a single file, called a package. This makes it easier to deploy and install an application to the MC31XX. Package new applications and updates, such as new DLL files, as CAB files, then deploy them to the MC31XX. Refer to the *Microsoft Windows Mobile 6 Help* file for information on CAB files.

Software Installation on Development PC

To develop applications to run on the mobile computer, use the Developer Kit (EMDK) for C

The EMDK for C is a development tool used to create native C and C++ applications for all Zebra mobile computers. It includes documentation, header files (.H), and library files (.LIB) for native code application development that targets Zebra value-add APIs.

The software requirements to use the EMDK for C are:

- Microsoft Windows XP 32-bit Edition or Microsoft Windows Vista 32-bit Edition
- Microsoft ActiveSync 4.5 or higher. (only for Windows XP, Windows Vista has its own Mobile Device Center)
- If developing applications for Windows Mobile 6.X or Windows CE 6.0
 - Microsoft® Visual Studio 2005
 - Microsoft® Visual Studio 2005 Service Pack1
- (or)
- Microsoft® Visual Studio 2008
- Microsoft® Visual Studio 2008 Service Pack1
- One or more of the following Platform SDK's:
 - Windows Mobile 6 Professional and Standard Software Development Kits Refresh
- For Windows CE embedded development use the Zebra Platform SDK (PSDK) for your specific device. The PSDK can be found on the device download page at <http://www.zebra.com/support>

EMDK for C

To download and install the EMDK for C:

1. Download the EMDK from the Support Central web site, <http://www.zebra.com/support>.
 - a. Select *Mobile Computers*. The *Mobile Computer Products* page displays.
 - b. Select *MC3100*. The *MC3100 Product* page displays.
 - c. On the *MC3100 Product* page, select the appropriate *Developer Kit for C* from the *Software Downloads* section. The *Developer Kit for C* page displays.
 - d. Select the latest version, and save the .exe file to the development computer.
2. Locate the .exe file on the development computer, double-click the executable file and follow the install screen prompts.
3. Once installed, access the components of the EMDK for C from the *Developer Kit for C* program group of the *Windows Start* menu.
4. The sample applications provide examples of how to interface with the Zebra API functions. To build a sample application, open the *Samples* folder from the *Windows Start* menu. Open the folder for the desired sample and then open the project file. The project file has an extension of VCP. Microsoft Visual C++ v4.0 automatically launches. Select *WinCE* as the Active WCE Configuration. Select *Win32 (WCE ARMV4) Debug* as the active configuration.

✓ **NOTE** If both Microsoft Visual C++ v3.0 and Microsoft Visual C++ v4.0 are installed on the development computer, ensure Microsoft Visual C++ v4.0 launches.

Installing Other Development Software

Developing applications for the mobile computer may require installing other development software, such as application development environments, on the development PC. Follow the installation instructions provided with the software.

Software Updates

Download updates to the EMDK for C from the Support Central web site at: <http://www.zebra.com/support>. Check this site periodically for important updates and new software versions.

Windows Mobile File Storage

Windows Mobile 6.1 contains three types of file storage:

- Random Access Memory (RAM)
- Persistent Storage
- Application folder.

Random Access Memory

Executing programs use RAM to store data. Data stored in RAM is lost upon a warm boot. RAM also included a volatile file storage area called *Cache Disk*.

Volatile File Storage (Cache Disk)

Windows Mobile 6.1 memory architecture uses persistent storage for all files, registry settings, and database objects to ensure data is retained even after a power failure. Persistent storage is implemented using Flash memory technology which is generally slower than volatile RAM memory. In certain situations the speed of the operation is more important than the integrity of the data. For these situations, Zebra has provided a small volatile File Storage volume, accessed as the *Cache Disk* folder. Disk operations to the *Cache Disk* folder are much faster than to any of the persistent storage volumes, but data is lost across warm boots and power interruptions. Note that a backup battery powers RAM memory, including the *Cache Disk*, when you remove the main battery for a short period of time.

The MC31XX uses the *Cache Disk* for temporary data that can be restored from other sources, for example, for temporarily “caching” HTML web pages by a browser or generating formatted files to send to a printer. Both situations benefit from the increased speed of the cache disk, but you can restore the data if needed.

DO NOT use the *Cache Disk* as a method to improve application performance. Analyze applications that perform slower in persistent storage to optimize disk access. Common areas for optimization include minimizing the number of reads and writes to a file, removing unneeded debug logging, and minimizing file flushing or closing files.

Persistent Storage

Windows Mobile 6.1 protects all data and applications from power-related loss. Because Windows Mobile 6.1 mounts the entire file system and registry in persistent storage (rather than using RAM), MC31XX devices provide a reliable storage platform even in the absence of battery power.

Persistent storage provides application developers with a reliable storage system available through the standard file system and registry APIs. Persistent storage is optimized for large reads and writes; therefore, applications reading and writing data in large chunks tend to outperform those applications reading and writing small blocks of data. Data in persistent storage is lost upon a clean boot.

Persistent storage contains all the directories under the root directory except for Application, Cache Disk, and Storage Card (if a storage card is installed). Persistent storage is approximately 60 MB (formatted).

Application Folder

The Application folder is a super-persistent storage that is persistent even after a clean boot. Accessing data in the Application folder is slower than accessing persistent storage. The Application folder is used for deployment and device-unique data. For example, network profiles can be stored in the Application folder so that connection to the network is available after a cold boot. The Application folder is approximately 20 MB (formatted).

Deployment

This section provides information about installing software and files on the MC31XX.

Software deployment can be performed by:

- Copying files from a host computer
- Installing programs
- Updating images.

Copying Files from a Host Computer

To copy files from a host computer to the MC31XX:

1. Ensure that ActiveSync is installed on the host computer and that a partnership was created. For more information see, [Chapter 3, ActiveSync](#).
2. Connect the mobile computer to the host computer using a Single Slot Serial/USB cradle or an appropriate cable. See, [Chapter 2, Accessories](#) for connection information.
3. On the host computer, select **Start > Programs > ActiveSync**.

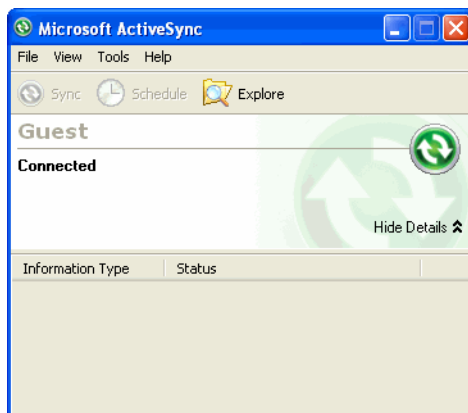

Figure 5-1 ActiveSync Connected Window

4. Select *Explore*.

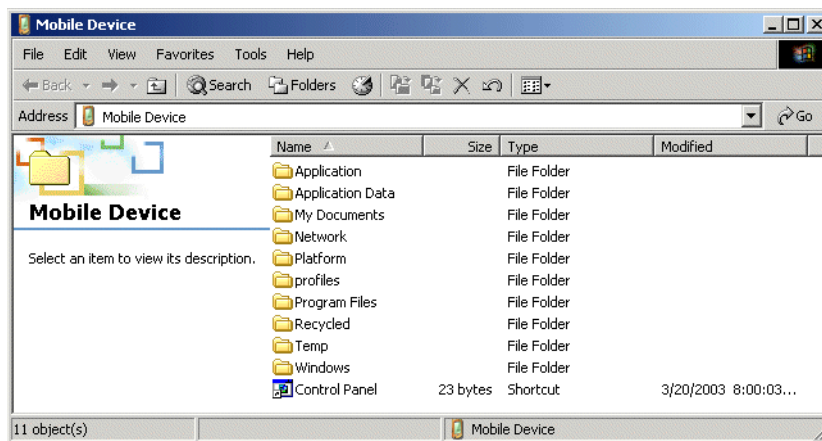

Figure 5-2 ActiveSync Explorer

5. Double-click the folder to expand the folder contents.

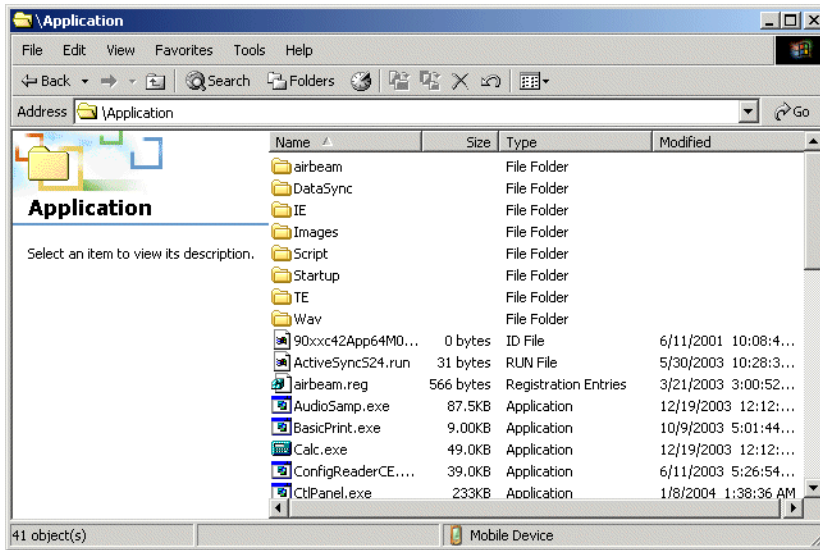

Figure 5-3 Application Folder Contents

- Use Explorer to locate the host computer directory that contains the file to download. Tap that directory in the left pane to display its contents in the right pane.
- Drag the desired file(s) from the host computer to the desired mobile device folder.

Adding Programs

Install the appropriate software on the host computer before installing it on the mobile computer:

- Download the program to the host computer (or insert the CD or disk that contains the program into the host computer). The program may consist of a single *.xip file, *.exe file, a *.zip file, or a Setup.exe file.
- Read any installation instructions, ReadMe files, or documentation that comes with the program. Many programs provide special installation instructions.
- Connect the mobile computer to the host computer using an accessory described in [Chapter 2, Accessories](#).
- Ensure that a connection is established.
- Double-click the executable file on the host computer.

If the file is an installer, the installation wizard begins. Follow the directions on the window. Once the software is installed on the host computer, the installer transfers the software to the mobile computer.

If the file is not an installer, an error message states that the program is valid but is designed for a different type of computer. Copy this file to the mobile computer. Follow the installation instructions for the program in the ReadMe file or documentation, or use ActiveSync Explore to copy the program file to the Program Files folder on the mobile computer as described in [Copying Files from a Host Computer on page 5-9](#). For more information on copying files using ActiveSync, refer to ActiveSync Help.

- When installation is complete, tap **Start > Programs** on the mobile computer, then tap the program icon.

Adding a Program from the Internet

- Download the program to the mobile computer from the Internet using **Internet Explorer**.

2. Read any installation instructions, Read Me files, or documentation that comes with the program. Many programs provide special installation instructions.
3. Tap the file, such as a .xip or .exe file, to launch the installation wizard. Follow the directions on the window.

Updating Images

The MC31XX contains tools that update all operating system components. All updates are distributed as packages. Update packages can contain either partial or complete updates for the operating system. Zebra distributes the update packages on the Support Central Web Site, <http://www.zebra.com/support>.

Update an operating system component using one of the following:

- MSP. See *Mobility Services Platform on page 5-12* for information.
- Update Loader on Windows Mobile devices.

Windows Mobile Update Loader

Packages can be downloaded to the MC31XX using the MC31XX temp directory or an SD card.

Using MC31XX Temp Directory

To initiate an update using the temp directory:

1. Go to the Support Central web site, <http://www.zebra.com/support> and download the appropriate update package.
2. Connect the MC31XX to a host computer using the Single Slot Serial/USB Cradle or USB Communication Cable. See *Chapter 2, Accessories*.
3. Using ActiveSync, copy the update package to the \temp directory on the MC31XX.
4. Simultaneously press the **Power** button and the **1** and **9** keys.
5. Immediately, as soon as the device starts to boot, press and hold the left scan button or the trigger.
6. When the update loader screen appears, release the left scan button or trigger.
7. When the Update Loader application finds the appropriate file, it loads the package onto the MC31XX. A progress bar displays until the update completes.
8. When complete, the MC31XX re-boots.
9. The calibration screen appears.

Using SD Card

To initiate an update using an SD card:

1. Go to the Support Central web site, <http://www.zebra.com/support>.
2. Download the appropriate update package.
3. Copy the update package to the root directory of an SD card.
4. Remove the battery.
5. Install the SD card in the MC31XX.

6. Replace the battery and battery door.
7. Connect the MC31XX to AC power. See [Chapter 2, Accessories](#).
8. Simultaneously press the **Power** button and the **1** and **9** keys.
9. Immediately, as soon as the device starts to boot, press and hold the left scan button or the trigger.
10. When the update loader screen appears, release the left scan button or trigger.
11. When the Update Loader application finds the appropriate file, it loads the package onto the MC31XX. A progress bar displays until the update completes.
12. When complete, the MC31XX re-boots.
13. The calibration screen appears.

Mobility Services Platform

The MSP 3 Client Software is a set of software components that come pre-installed on the MC31XX. The MSP 3 Client software consists of the following components:

The RD Client provides support for MSP 3 Staging functionality, provides support for the MSP 3 Legacy Staging process, and provides support for backward-compatible legacy MSP 2.x Legacy Staging functionality.

The MSP 3 Agent provides MSP 3 Provisioning functionality and Control functionality when used with MSP 3.2 Control Edition.

Refer to the *Mobility Services Platform 3.2 User's Guide*, p/n 72E-100158-06, for instructions for using the Rapid Deployment and MSP3 Agent clients.

Creating a Splash Screen

A custom splash screen can be created and loaded onto the MC31XX. To create a custom splash screen:

1. Create a .bmp file using a graphic program with the following specifications:
 - Size: 320 (W) x 240 (H).
 - Colors: 256.
2. Modify the bitmap file and save.

To load the splash screen on the MC31XX Windows Mobile device:

1. Create a text file named pkgs.lst which contains the name of the bmp file. For example, *mysplash.bmp*.
2. Copy the bmp file and the pkgs.lst file to one of the following:
 - MC31XX's \temp directory
 - MC31XX's \Windows directory.
3. Perform a cold boot.
4. Press the trigger or side scan button for 5 seconds while booting to invoke the Update Loader and install the splash screen.

Chapter 6 Wireless Applications

Introduction

Wireless Local Area Networks (LANs) allow mobile computers to communicate wirelessly and send captured data to a host device in real time. Before using the MC3100 on a WLAN, the facility must be set up with the required hardware to run the wireless LAN and the MC3100 must be configured. Refer to the documentation provided with the access points (APs) for instructions on setting up the hardware.

- ✓ **NOTE** 802.11d is enabled by default. When enabled, the AP must be configured the same in order to connect.

To configure the MC3100, a set of wireless applications provide the tools to configure and test the wireless radio in the MC3100. Refer to the *Wireless Fusion Suite User Guide for Version 3.00* for information on configuring wireless profiles. Go to <http://www.zebra.com/support> for the latest version of this guide. See [Software Versions on page xii](#) to determine the Fusion version on the MC3100.

- ✓ **NOTE** Select the Country for the MC3100's country of operation. The access point prompts for the correct country code on the first login. A warning message also displays stating an incorrect country setting may result in illegal radio operation. Selecting the correct country is central to legally operating the access point. Each country has its own regulatory restrictions concerning electromagnetic emissions and the maximum RF signal that can be transmitted. To ensure compliance with national and local laws, set the country accurately. MC3100 users cannot configure their access point until a two character country code (for example, United States - us) is set. The Country setting drop-down list in the US version of the MC3100 only contains "US" in the list. The Country setting drop-down list in the WW version does not contain "US" in the list.

Tap the **Signal Strength** icon to display the **Wireless Launcher** menu.

- ✓ **NOTE** On devices with Windows Mobile 6.5.3, access the Wireless launcher from the Home screen. Select the Fusion plug-in and then tap the **Fusion Menu** button. See [Home Screen on page C-1](#) for more information.



Signal Strength Icon

Figure 6-1 *Wireless Application Menu*

Many of the items in the menu invoke one of the Fusion applications. These menu items and their corresponding applications are summarized below:

- Find WLANs – Invokes the Find WLANs application which displays a list of the WLANs active in your area. The **Wireless Application** menu on the task tray provides the following wireless applications:
- Manage Profiles – Invokes the Manage Profiles application (which includes the Profile Editor Wizard) to manage and edit your list of WLAN profiles.
- Manage Certs – Invokes the Certificate Manager application which allows you to manage certificates used for authentication.
- Manage PACs – Invokes the PAC Manager application which helps you manage the list of Protected Access Credentials used with EAP-FAST authentication.
- Options – Invokes the Options application which allows you to configure the Fusion option settings.
- Wireless Status – Invokes the Wireless Status application which allows you to view the status of the current wireless connection.
- Wireless Diagnostics – Invokes the Wireless Diagnostics application which provides tools with which to diagnose problems with the wireless connection.
- Log On/Off – Invokes the Network Login dialog which allows you to log on to a particular profile or to log off from the currently active profile.







Additional Wireless Launcher menu entries include:

- Enable/Disable Radio
- Hide Menu
- Exit.

Signal Strength Icon

The **Signal Strength** icon in the task tray indicates the mobile computer's wireless signal strength as follows:

Table 6-1 *Signal Strength Icons Descriptions*

Icon	Status	Action
	Excellent signal strength	Wireless LAN network is ready to use.
	Very good signal strength	Wireless LAN network is ready to use.
	Good signal strength	Wireless LAN network is ready to use.
	Fair signal strength	Wireless LAN network is ready to use. Notify the network administrator that the signal strength is only "Fair".
	Poor signal strength	WLAN network is ready to use. Performance may not be optimum. Notify the network administrator that the signal strength is "Poor".
	Out-of-network range (not associated)	No WLAN network connection. Notify the network administrator.
	The WLAN radio is disabled.	WLAN radio is disabled. To enable, choose Enable Radio from the Wireless Applications menu.
None	The Wireless Launcher application was exited.	The Wireless Launcher application has been closed.

Turning Off the Radio

On Device with Windows CE 6.0

To turn off the WLAN radio tap the **Signal Strength** icon on the task tray and select **Disable Radio**. A red X appears across the icon indicating that the radio is disabled (off).

**Figure 6-2** *Wireless Connection Status Icon*

To turn the radio back on, tap the **Signal Strength** icon on the task tray and select **Enable Radio**. The red X disappears from the icon indicating that the radio is enabled (on).

On Device with Windows Mobile 6.1

Windows Mobile 6.1 devices include **Wireless Manager**, which provides a simple method of enabling, disabling the WLAN radio.

To open **Wireless Manager**, tap the **Connectivity** icon.

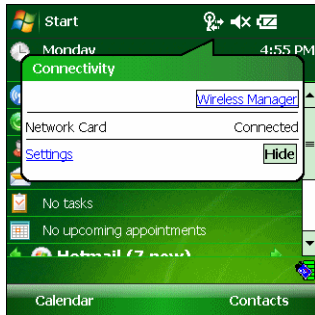

Figure 6-3 *Opening Wireless Manager*

Select **Wireless Manager**.



Figure 6-4 *Wireless Manager Window*

To enable or disable the WLAN radio, tap the **Wi-Fi** bar.

Chapter 7 Interactive Sensor Technology Configuration

Introduction

This chapter provides information for configuring the Interactive Sensor Technology (IST) settings. IST settings can be accessed:

- Tap **Start > Settings > System > IST Settings** icon.
- Tap the **IST Settings** icon in the Command bar.



Figure 7-1 *IST Settings Icon*

IST Menu

Tap the **IST Settings** icon to open the menu. This menu lists IST configuration settings.

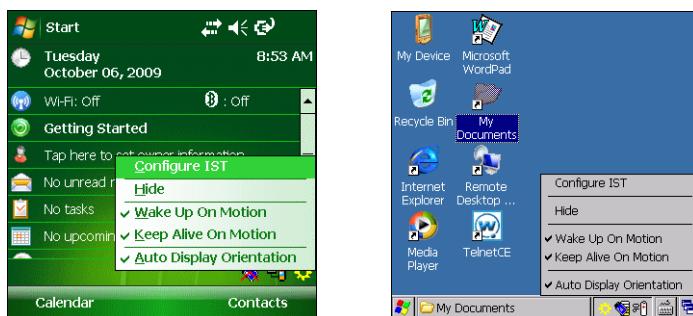

Figure 7-2 *IST Settings Icon Menu*

Use this menu to access the configuration settings listed in [Table 7-1](#). An enabled options is indicated with a check mark next to the option.

Table 7-1 IST Tray Icon Menu Items

Menu Item	Description
Configure IST	Opens the IST Settings window.
Hide	Removes IST Settings icon from the Command bar.
Wake Up On Motion	Wakes the MC31XX from suspend mode if it was placed in suspend mode due to inactivity.
Keep Alive On Motion	Prevents going into suspend mode motion is detected. See Keep Alive On Motion on page 7-3 for more information.
Auto Display Orientation	Enables auto display orientation. See Display Tab on page 7-4 for more information.

General Tab

Use the **General** tab to view IST software information and control the display of the **IST Setting** icon.

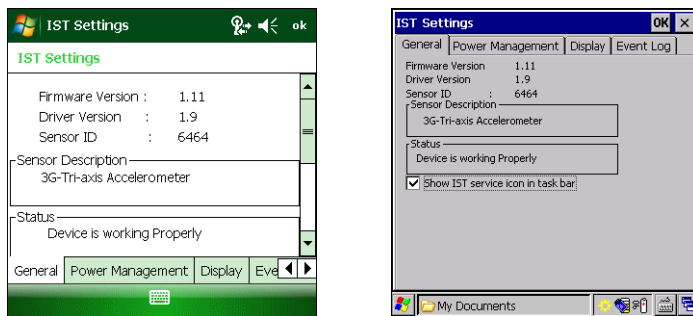
**Figure 7-3** General Tab**Table 7-2** IST General Tab Information

Item	Description
Firmware Version	Displays the version information of IST device firmware.
Driver Version	Displays the version information of IST driver.
Sensor ID	Displays identification tag of the sensor.
Sensor Description	Displays a description of the sensor.
Status	Displays status information of the IST device. If the IST is not working properly it displays the error message. Device working Properly - Normal state. IST Hardware not present - When there is no response from IST hardware. Please contact service department. Need calibration - Device is not calibrated. Contact your system administrator.
Show IST service icon in task bar	Enables the IST Setting icon to display in the Command bar.

Power Management Tab

Use the **Power Management** tab to configure power management settings.

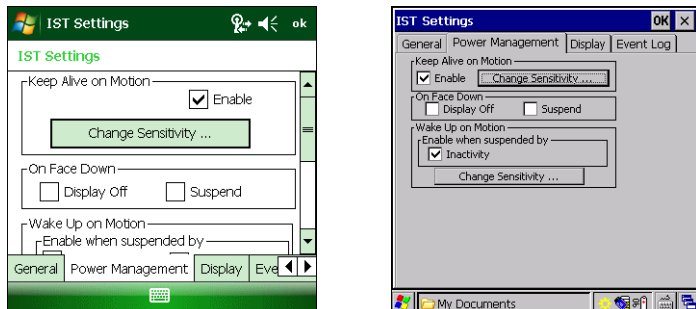

Figure 7-4 Power Management Tab

Keep Alive On Motion

Select the **Enabled** checkbox to prevent the MC31XX from going into suspend mode while it is in motion. The motion sensitivity is configurable. To set the sensitivity, tap the **Change Sensitivity...** button.

- ✓ **NOTE** There is no time out defined for suspend due to IST inactivity. To aggressively manage power, while there is no motion, set the MC31XX suspend time out to a very short time using system power settings. This setting suspends the MC31XX when there is no motion activity or any other activity within this set time out.

On Face Down

The **On Face Down** section provides configurable options to control what happens when the MC31XX is placed with the display face down.

Select the **Display Off** checkbox to turn off the backlight when the MC31XX is placed face-down. The backlight automatically powers on when the MC31XX is tuned face-up.

Select the **Suspend** checkbox to suspend the MC31XX when it placed face-down. To wake the MC31XX use the controls listed in the **Wake Up on Motion** section below.

Wake Up on Motion

The **Wake Up on Motion** section provides configurable options for waking the MC31XX from suspend mode by shaking the MC31XX.

Select **Inactivity** checkbox to allow IST to wake the MC31XX when it was suspended due to inactivity.

Use the **Change Sensitivity...** button to configure the sensitivity settings.

Setting Sensitivity

Use the slider to set the sensitivity. A low setting indicates that a harder shake (faster movement) is required for the IST to initiate a wake up action. The sensitivity can be set from “0” to “10” and when the sensitivity is set to lower values a simple shake/motion can be detected by IST. A high setting allows IST to issue a wake up action when an easier movement to the MC31XX is detected. Shake the MC31XX to test the set sensitivity. An audio sound is heard and a message is displayed on screen when the shaking level reaches the set sensitivity level.

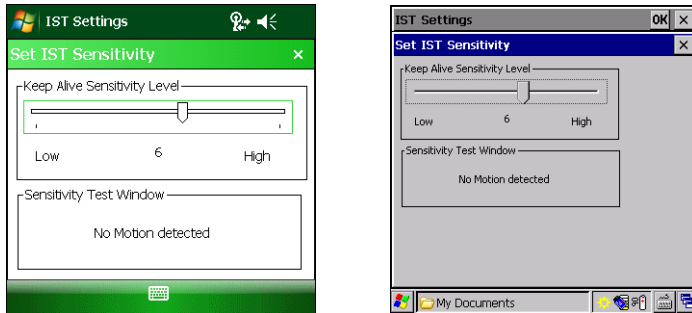

Figure 7-5 Set IST Sensitivity Window

Display Tab

Use the **Display** tab configure display interaction settings.

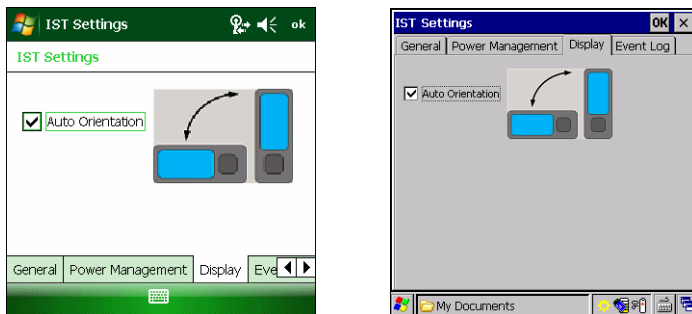

Figure 7-6 Display Tab

The Auto Orientation parameter controls the display rotation according to the MC31XX orientation. Select the **Auto Orientation** checkbox to enable this feature. Auto orientation is disabled by default.

Event Log Tab

Use the **Event Log** tab to display the event details. This feature in IST mainly focuses on abuse by dropping the device.

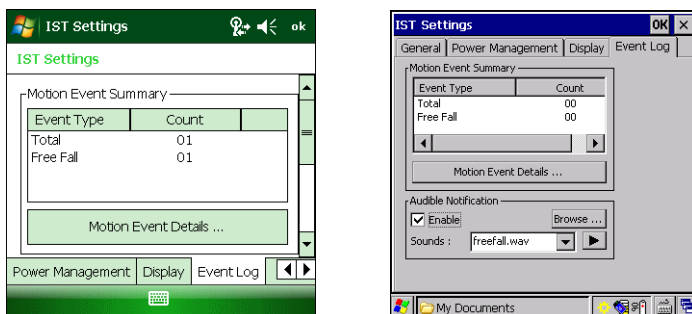

Figure 7-7 Event Log Tab

The **Motion Event Summary** list displays a summary of the event report. To view the full report tap the **Motion Event Details...** button.

Use the Audible Notification panel to enable playing of a wave file when the MC31XX is dropped. Select a desired .wav file from the Sounds: drop-down list.

Motion Event Details

The **Motion Event Detail** list displays the date and time, duration and the type of the drop event. This event list can display up to last 32 motion events. A drop event is registered when the MC31XX drops 1.07 m (42 in.) in normal operation and 1.27 m (50 in.) in suspend mode.

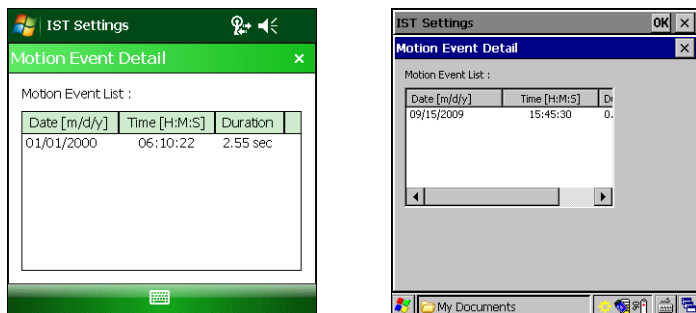

Figure 7-8 Motion Event Detail Window

Chapter 8 Maintenance & Troubleshooting

Introduction

This chapter includes instructions on cleaning and storing the mobile computer, and provides troubleshooting solutions for potential problems during mobile computer operation.

Maintaining the Mobile Computer

For trouble-free service, observe the following tips when using the mobile computer:

- Do not scratch the screen of the mobile computer. When working with the mobile computer, use the supplied stylus or plastic-tipped pens intended for use with a touch-sensitive screen. Never use a pen or pencil or other sharp object on the surface of the mobile computer screen.
- Although the mobile computer is water and dust resistant, do not expose it to rain or moisture for an extended period of time. In general, treat the mobile computer as a pocket calculator or other small electronic instrument.
- The touch-sensitive screen of the mobile computer is glass. Do not drop the mobile computer or subject it to strong impact.
- Protect the mobile computer from temperature extremes. Do not leave it on the dashboard of a car on a hot day, and keep it away from heat sources.
- Do not store or use the mobile computer in any location that is extremely dusty, damp, or wet.
- Use a soft lens cloth to clean the mobile computer. If the surface of the mobile computer screen becomes soiled, clean it with a soft cloth moistened with a diluted window-cleaning solution.

Battery Safety Guidelines



WARNING! Failure to follow these guidelines may result in fire, explosion, or other hazard.

- The area in which the units are charged should be clear of debris and combustible materials or chemicals. Particular care should be taken where the device is charged in a non commercial environment.
- Follow battery usage, storage, and charging guidelines found in the user's guide.
- Improper battery use may result in a fire, explosion, or other hazard.
- Do not use a tool to remove the battery from the mobile computer or battery charging accessory.
- To charge the mobile device battery, the battery and charger temperatures must be between +32°F and +104°F (0°C and +40°C)
- Do not use incompatible batteries and chargers. Use of an incompatible battery or charger may present a risk of fire, explosion, leakage, or other hazard. If you have any questions about the compatibility of a battery or a charger, contact Zebra support.
- For devices that utilize a USB port as a charging source, the device shall only be connected to products that bear the USB-IF logo or have completed the USB-IF compliance program.
- To enable authentication of an approved battery, as required by IEEE1725 clause 10.2.1, all batteries will carry a Zebra hologram. Do not fit any battery without checking it has the Zebra authentication hologram.
- Do not disassemble or open, crush, bend or deform, puncture, or shred.
- Severe impact from dropping any battery-operated device on a hard surface could cause the battery to overheat.
- Do not short circuit a battery or allow metallic or conductive objects to contact the battery terminals.
- Do not modify or remanufacture, attempt to insert foreign objects into the battery, immerse or expose to water or other liquids, or expose to fire, explosion, or other hazard.
- Do not leave or store the equipment in or near areas that might get very hot, such as in a parked vehicle or near a radiator or other heat source. Do not place battery into a microwave oven or dryer.
- Battery usage by children should be supervised.
- Please follow local regulations to promptly dispose of used re-chargeable batteries.
- Do not dispose of batteries in fire.
- Seek medical advice immediately if a battery has been swallowed.
- In the event of a battery leak, do not allow the liquid to come in contact with the skin or eyes. If contact has been made, wash the affected area with large amounts of water and seek medical advice.
- If you suspect damage to your equipment or battery, contact Zebra support to arrange for inspection.

Storage

When storing the MC31XX for long periods it is recommended to remove the main battery and place the device in storage mode. This disconnects the backup battery preventing it from completely discharging while being stored.

1. Ensure that the backup battery is fully charged.
2. Remove the main battery.
3. Simultaneously press the **1**, **9** and **Power** keys for three seconds.

The backup battery charge level should be verified at least once a year and charged to full charge.

Cleaning



CAUTION Always wear eye protection.

Read warning label on compressed air and alcohol product before using.

If you have to use any other solution for medical reasons please contact Zebra for more information.



WARNING! Avoid exposing this product to contact with hot oil or other flammable liquids. If such exposure occurs, unplug the device and clean the product immediately in accordance with these guidelines.

Materials Required

- Alcohol wipes
- Lens tissue
- Cotton tipped applicators
- Isopropyl alcohol
- Can of compressed air with a tube.

Cleaning the MC31XX

Housing

Using the alcohol wipes, wipe the housing including keys and in-between keys.

Display

The display can be wiped down with the alcohol wipes, but care should be taken not to allow any pooling of liquid around the edges of the display. Immediately dried the display with a soft, non-abrasive cloth to prevent streaking.

Scanner Exit Window

Wipe the scanner exit window periodically with a lens tissue or other material suitable for cleaning optical material such as eyeglasses.

Connector

1. Remove the main battery from mobile computer.
2. Close battery door.
3. Dip the cotton portion of the cotton tipped applicator in isopropyl alcohol.
4. Rub the cotton portion of the cotton tipped applicator back-and-forth across the connector on the bottom of the MC31XX. Do not leave any cotton residue on the connector.
5. Repeat at least three times.
6. Use the cotton tipped applicator dipped in alcohol to remove any grease and dirt near the connector area.
7. Use a dry cotton tipped applicator and repeat steps 4 through 6.

8. Spray compressed air on the connector area by pointing the tube/nozzle about ½ inch away from the surface. CAUTION: Do not point nozzle at yourself and others, ensure the nozzle or tube is away from your face.
9. Inspect the area for any grease or dirt, repeat if required.

Cleaning Cradle Connectors

To clean the connectors on a cradle:

1. Remove the DC power cable from the cradle.
2. Dip the cotton portion of the cotton tipped applicator in isopropyl alcohol.
3. Rub the cotton portion of the cotton tipped applicator along the pins of the connector. Slowly move the applicator back-and-forth from one side of the connector to the other. Do not let any cotton residue on the connector.
4. All sides of the connector should also be rubbed with the cotton tipped applicator.
5. Spray compressed air in the connector area by pointing the tube/nozzle about ½ inch away from the surface. CAUTION: do not point nozzle at yourself and others, ensure the nozzle or tube is pointed away from your face.
6. Ensure that there is no lint left by the cotton tipped applicator, remove lint if found.
7. If grease and other dirt can be found on other areas of the cradle, use lint free cloth and alcohol to remove.
8. Allow at least 10 to 30 minutes (depending on ambient temperature and humidity) for the alcohol to air dry before applying power to cradle.

If the temperature is low and humidity is high, longer drying time is required. Warm temperature and dry humidity requires less drying time.

Cleaning Frequency

The cleaning frequency is up to the customer's discretion due to the varied environments in which the mobile devices are used. They may be cleaned as frequently as required. However when used in dirty environments it may be advisable to periodically clean the scanner exit window to ensure optimum scanning performance.

Troubleshooting

Mobile Computer

Table 8-1 Troubleshooting the Mobile Computer

Problem	Cause	Solution
Mobile computer does not turn on.	Main battery not charged.	Charge or replace the main battery in the mobile computer.
	Main battery not installed properly.	Ensure the battery is installed properly. For more information see, Install Main Battery on page 1-7 .
	System crash.	Perform a warm boot. If the mobile computer still does not turn on, perform a cold boot. For more information see, Resetting the Mobile Computer on page 1-11 .
Battery did not charge.	Battery failed.	Replace battery. If the mobile computer still does not operate, try a warm boot, then a cold boot. For more information see, Resetting the Mobile Computer on page 1-11 .
	Mobile computer removed from cradle while battery was charging.	Insert mobile computer in cradle and begin charging. The Standard Battery requires up to five hours to recharge fully and the Extended Life Battery requires up to eight hours to recharge fully.
	Extreme battery temperature.	Battery does not charge if ambient temperature is below 32°F (0°C) or above 104°F (40°C).
Cannot see characters on screen.	Mobile computer not powered on.	Press the Power button.
During data communication, no data was transmitted, or transmitted data was incomplete.	Mobile computer removed from cradle or unplugged from host computer during communication.	Replace the mobile computer in the cradle, or reattach the cable and re-transmit.
	Incorrect cable configuration.	See Chapter 2, Accessories for cable configurations.
	Communication software was incorrectly installed or configured.	Perform communication setup as described in Chapter 3, ActiveSync .
Mobile computer does not emit sound.	Volume setting is low or turned off.	Mobile computer may be a beeper only configuration or incorrect setting is programmed into device.

Table 8-1 Troubleshooting the Mobile Computer (Continued)

Problem	Cause	Solution
Mobile computer turns itself off.	Mobile computer is inactive.	The mobile computer turns off after a period of inactivity. This period can be set from one to five minutes, in one-minute intervals.
	Battery is depleted.	Recharge or replace the battery.
	Battery is not inserted properly.	Insert the battery properly. For more information see, Install Main Battery on page 1-7 .
Tapping the window buttons or icons does not activate the corresponding feature.	Touch screen not calibrated correctly.	Re-calibrate the screen. From the mobile computer, Demo window double-tap the Ctl Panel icon and double-tap on Touch Calibrate . Follow the screen prompts.
	The system crashed.	Warm boot the system. To perform a warm boot, see Resetting the Mobile Computer on page 1-11 .
A message appears stating that the mobile computer memory is full.	Too many files stored on the mobile computer.	Delete unused memos and records. If necessary, save these records on the host computer.
	Too many applications installed on the mobile computer.	Remove unused installed applications from the mobile computer to recover memory.
The mobile computer does not accept scan input.	Scanning application is not loaded.	Verify that the mobile computer is loaded with a scanning application.
	Unreadable bar code.	Ensure the symbol is not defaced.
	Distance between scan window and bar code is incorrect.	Ensure the mobile computer is within proper scanning range.
	Mobile computer is not programmed for the bar code type.	Ensure the mobile computer is programmed to accept the type of bar code scanned.
	Mobile computer is not programmed to generate a beep.	If a beep on a good decode is expected and a beep is not heard, check that the application is set to generate a beep on good decode.
	Battery is low.	Check the battery level. When the battery is low, the mobile computer automatically goes into suspend mode.

Single Slot Serial/USB Cradle

Table 8-2 Troubleshooting the Single Slot Serial/USB Cradle

Problem	Cause	Solution
Mobile computer amber Charge LED Indicator does not light when mobile computer inserted.	Cradle is not receiving power.	Ensure the power cable is connected securely to both the cradle and to AC power.
	Mobile computer is not correctly seated.	Remove and re-insert the mobile computer into the cradle, ensuring it is correctly seated.
Spare Battery Charging LED does not light when spare battery is inserted.	Spare battery is not correctly seated.	Remove and re-insert the spare battery into the charging slot, ensuring it is correctly seated.
Mobile computer battery is not charging.	Mobile computer was removed from cradle or cradle was unplugged from AC power too soon.	Ensure cradle is receiving power. Ensure the mobile computer is seated correctly. If the mobile computer battery is fully depleted, it can take up to five hours to fully recharge a Standard Battery and it can take up to eight hours to fully recharge an Extended Life Battery.
	Battery is faulty.	Verify that other batteries charge properly. If so, replace the faulty battery.
	The mobile computer is not fully seated in the cradle.	Remove and re-insert the mobile computer into the cradle, ensuring it is correctly seated.
Spare battery is not charging.	Battery not fully seated in charging slot.	Remove and re-insert the spare battery into the cradle, ensuring it is correctly seated.
	Battery inserted incorrectly.	Ensure the contacts are facing down and toward the back of the cradle.
	Battery is faulty.	Verify that other batteries charge properly. If so, replace the faulty battery.
During data communication, no data was transmitted, or transmitted data was incomplete.	Mobile computer removed from cradle during communication.	Replace mobile computer in cradle and retransmit.
	Incorrect cable configuration.	See Chapter 2, Accessories for cable configurations.
	Communication software is not installed or configured properly.	Perform communication setup as described in Chapter 3, ActiveSync .

Four Slot Charge Only Cradle

Table 8-3 Troubleshooting the Four Slot Charge Only Cradle

Problem	Cause	Solution
Mobile computer amber Charge LED Indicator does not light when mobile computer inserted.	Cradle is not receiving power.	Ensure the power cable is connected securely to both the cradle and to AC power.
	Mobile computer is not correctly seated.	Remove and re-insert the mobile computer into the cradle, ensuring it is correctly seated.

Table 8-3 Troubleshooting the Four Slot Charge Only Cradle (Continued)

Problem	Cause	Solution
Mobile computer battery is not charging.	Mobile computer was removed from cradle or cradle was unplugged from AC power too soon.	Ensure cradle is receiving power. Ensure mobile computer is seated correctly. If the mobile computer battery is fully depleted, it can take up to five hours to fully recharge a Standard Battery and it can take up to eight hours to fully recharge an Extended Life Battery.
	Battery is faulty.	Verify that other batteries charge properly. If so, replace the faulty battery.
	The mobile computer is not fully seated in the cradle.	Remove and re-insert the mobile computer into the cradle, ensuring it is correctly seated.

Four Slot Ethernet Cradle

Table 8-4 Troubleshooting the Four Slot Ethernet Cradle

Problem	Cause	Solution
Mobile computer amber Charge LED Indicator does not light when mobile computer inserted.	Cradle is not receiving power.	Ensure the power cable is connected securely to both the cradle and to AC power.
	Mobile computer is not correctly seated.	Remove and re-insert the mobile computer into the cradle, ensuring it is correctly seated.
Mobile computer battery is not charging.	Mobile computer was removed from cradle or cradle was unplugged from AC power too soon.	Ensure cradle is receiving power. Ensure mobile computer is seated correctly. If the mobile computer battery is fully depleted, it can take up to five hours to fully recharge a Standard Battery and it can take up to eight hours to fully recharge an Extended Life Battery.
	Battery is faulty.	Verify that other batteries charge properly. If so, replace the faulty battery.
	The mobile computer is not fully seated in the cradle.	Remove and re-insert the mobile computer into the cradle, ensuring it is correctly seated.
During data communication, no data was transmitted, or transmitted data was incomplete.	Mobile computer removed from cradle during communication.	Replace mobile computer in cradle and retransmit.
	Incorrect cradle setup.	See Chapter 2, Accessories for cradle setup.
	Ethernet connection error. Link LED is not lit (see Link LED on page 2-13).	Troubleshoot the Ethernet connection.

Four Slot Spare Battery Charger

Table 8-5 Troubleshooting the Four Slot Spare Battery Charger

Problem	Cause	Solution
Spare Battery Charging LED does not light when spare battery is inserted.	Spare battery is not correctly seated.	Remove and re-insert the spare battery into the charging slot, ensuring it is correctly seated.
Battery not charging.	Charger is not receiving power.	Ensure the power cable is connected securely to both the charger and to AC power.
	Battery is not correctly seated.	Remove and re-insert the battery into the charger, ensuring it is correctly seated.
	Battery was removed from charger or charger was unplugged from AC power too soon.	Ensure charger is receiving power. Ensure the battery is seated correctly. If a battery is fully depleted, it can take up to five hours to fully recharge a Standard Battery and it can take up to eight hours to fully recharge an Extended Life Battery.
	Battery is faulty.	Verify that other batteries charge properly. If so, replace the faulty battery.

UBC Adapter

Table 8-6 Troubleshooting the UBC Adapter

Problem	Cause	Solution
Spare battery Charging LED does not light when spare battery is inserted.	Spare battery is not correctly seated.	Remove and re-insert the spare battery into the charging slot, ensuring it is correctly seated.
Battery not charging.	Charger is not receiving power.	Ensure the power cable is connected securely to both the charger and to AC power.
	Spare battery is not correctly seated.	Remove and re-insert the spare battery into the charger, ensuring it is correctly seated.
	Battery was removed from charger or charger was unplugged from AC power too soon.	Ensure charger is receiving power. Ensure the battery is seated correctly. If a battery is fully depleted, it can take up to five hours to fully recharge a Standard Battery and it can take up to eight hours to fully recharge an Extended Life Battery.
	Battery is faulty.	Verify that other batteries charge properly. If so, replace the faulty battery.

Cables

Table 8-7 Troubleshooting the Cables

Problem	Cause	Solution
Mobile computer amber Charge LED Indicator does not light when mobile computer attached.	Cable is not receiving power.	Ensure the power cable is connected securely to both the cable and to AC power.
	Mobile computer is not seated correctly in the cable.	Remove and re-insert the mobile computer into the MC31XX connector, ensuring it is correctly seated.
Mobile computer battery is not charging.	Mobile computer was detached from cable or cable was unplugged from AC power too soon.	Ensure the cable is receiving power. Ensure mobile computer is seated correctly. If the mobile computer battery is fully depleted, it can take up to five hours to fully recharge a Standard Battery and it can take up to eight hours to fully recharge an Extended Life Battery.
	Battery is faulty.	Verify that other batteries charge properly. If so, replace the faulty battery.
	The mobile computer is not fully seated in the cable.	Remove and re-insert the mobile computer into the cable, ensuring it is correctly seated.
During data communication, no data was transmitted, or transmitted data was incomplete.	Cable removed from mobile computer during communication.	Reattach cable to mobile computer and retransmit.
	Incorrect cable configuration.	See Chapter 2, Accessories for cable configurations.
	Communication software is not installed or configured properly.	Perform communication setup as described in Chapter 3, ActiveSync .

Appendix A Technical Specifications

Mobile Computer and Accessory Technical Specifications

[Table A-1](#) summarizes the mobile computer technical specifications and intended operating environments.

[Table A-2](#) summarizes the accessory technical specifications and the intended operating environments.

Table A-1 MC31XX Technical Specifications

Item	Description
Physical Characteristics	
Dimensions	MC31XXS: 7.49 in L x 3.25 in W x 1.77 in D (190.4 mm L x 82.6 mm W x 45.2 mm D) At grip: 2.40 in. W x 1.44 in. D/61.2 mm x 36.8 mm MC31XXR: 8.55 in L x 3.25 in W x 1.57 in D (217.12 mm L x 82.6 mm W x 39.9 mm D) At grip: 2.40 in. W x 1.14 in. D/61.2 mm x 29 mm MC3190G: 7.5 in L x 3.2 in W x 6.5 in D (193 mm L x 80.8 mm W x 166 mm H)
Weight (including battery, stylus, and handstrap)	MC31XXR (with standard battery)* - 13.52 oz (384 g) MC31XXS (with extended battery)* - 14.95 oz (424 g) MC3190G (with extended battery)* - 18.34 oz (520 g)
Display	3.0 inch Color (TFT) (320 x 320) display with backlight
Touch Panel	Analog resistive touch
Backlight	LED backlight

Table A-1 MC31XX Technical Specifications (Continued)

Item	Description
Battery	Standard: Rechargeable Lithium-Ion 2740 mAh minimum (3.7V) Extended Life: Rechargeable Lithium-Ion 4800 mAh minimum (3.7V)
Expansion Slot	User accessible SD/MMC slot up to 8 GB; approved for memory expansion only
Network Connections	High-speed USB client, full-speed USB host, Bluetooth and WiFi. USB host mode available with appropriate cables only.
Notification	Programmable LEDs; Audio notifications
Keypad Options	28-key Numeric 38-key Shifted Alpha (calculator-style integrated numeric keypad) 48-key Alpha-Numeric (calculator-style integrated numeric keypad)
Audio	Speaker, receiver, microphone, software support for full duplex capability, Bluetooth stereo.
Performance Characteristics	
CPU	Marvell PXA320 processor at 624 MHz
Operating System	Microsoft® Windows CE .NET 6.0 Professional Microsoft® Windows Mobile 6.1 or 6.5.3 Classic
Memory	128 MB RAM/256MB Flash, 128 MB RAM/512 MB Flash, 256 MB RAM/512 MB Flash or 256 MB RAM/1 GB Flash
Output Power	USB: 5 VDC @ 400 mA max.
User Environment	
Operating Temperature	-20°C to 50°C (-4°F to 122°F)
Storage Temperature	-40° to 70°C (-40° to 158°F) without battery
Charging Temperature	0° C to 40° C (32°F to 104°F)
Humidity	5 - 95% non-condensing
Drop Specification	Multiple 1.2 m (4 ft.) drops to concrete across the operating temperature range, Multiple 1.5 m (5 ft.) drops to concrete at ambient temperature 23° C (73° F); meets and exceeds MIL-STD 810G.
Tumble	500 1.64 ft./0.5 m tumbles (1,000 drops) at room temperature per IEC 68-2-32 tumble specification.
Electrostatic Discharge (ESD)	+/-15 kV air discharge +/- 8 kV direct discharge +/- 8 kV indirect discharge
Sealing	IP54 category 2; meets applicable EN 60529 sealing specifications.

Table A-1 MC31XX Technical Specifications (Continued)

Item	Description
Wireless LAN Data and Voice Communications	
Wireless Local Area Network (WLAN) radio	Tri-mode IEEE® 802.11a/b/g
Data Rates Supported	1, 2, 5.5, 6, 9, 11, 12, 18, 24, 36, 48, and 54 Mbps
Operating Channels	Chan 1-13 (2412-2472 MHz), Chan 14 (2484 MHz) Japan only; actual operating channels/frequencies depend on regulatory rules and certification agency
Security	WPA2 (Personal or Enterprise); 802.1x; EAP-TLS; TTLS (CHAP, MS-CHAP, MS-CHAPv2, PAP or MD5); PEAP (TLS, MSCHAPv2, EAP-GTC); LEAP, EAP-FAST (TLS, MS-CHAPv2, EAP-GTC); CCXv4 certified; support for IPv6; FIPS140-2 Certified
Spreading Technique	Direct Sequence Spread Spectrum (DSSS) and Orthogonal Frequency Division Multiplexing (OFDM)
Antenna	Internal antenna w/diversity
Voice Communication	Voice-over-IP ready, Wi-Fi™-certified, IEEE 802.11a/b/g direct sequence wireless LAN, Wi-Fi Multimedia™ (WMM), Zebra Voice Quality Manager (VQM)
Wireless PAN Data and Voice Communications	
Bluetooth	Class II, v2.1 with Enhanced Data Rate (EDR); integrated antenna
Regulatory	
Electrical Safety	Certified to UL60950-1, CSA C22.2 No. 60950-1, EN60950/IEC 60950-1
Environmental	RoHS-compliant
WLAN and Bluetooth (PAN)	USA: FCC Part 15.247, 15.407 Canada: RSS-210 EU: EN 300 328, EN 301 893 Japan: ARIB STD T33, T66, T70, T71 Australia: AS/NZS 4268s
RF Exposure	USA: FCC Part 2, FCC OET Bulletin 65 Supplement C Canada: RSS-102 EU: EN 62311 Australia: Radio communications Standard 2003
EMI/RFI Radio Version	USA: FCC Part 15 Canada: RSS210 Class B EU: EN 301 489-1, 489-17

Table A-1 MC31XX Technical Specifications (Continued)

Item	Description
EMI/RFI Batch Version	USA: FCC Part 15 Canada: ICES 003 Class B EU: EN55022 Class B EN55024 Japan: CISPR 22, Class B Australia: AS3548
Laser Safety	IEC Class2/FDA Class II in accordance with IEC60825-1/EN60825-1
Data Capture Specifications	
Options	1D laser scanner 2D imager
Laser 1D Scanner (SE950) Specifications	
Range on 100% UPCA	Near: 3.8 cm (1.5 in.) Far: 60 cm (24 in.)
Optical Resolution	0.004 in. minimum element width
Roll	+/- 35° from vertical
Pitch Angle	+/- 65° from normal
Skew Tolerance	+/- 50° from normal
Ambient Light	10,000 ft. candles/107,640 lux
Scan Rate	104 (+/- 12) scans/sec (bidirectional)
Scan Angle	47° ± 3° default; configurable narrow angle: 35° ± 3°
2D Imager Engine (SE4500-SR) Specifications	
Range on 100% UPCA at 30 ft./candles	Near: 6.35 cm (2.5 in.) Far: 36.07 cm (14.2 in.)
Field of View	Horizontal - 38° Vertical - 25°
Optical Resolution	752 x 480 pixels
Roll	360°
Pitch Angle	+/- 60° from normal
Skew Tolerance	+/- 60° from normal
Ambient Light	9,000 ft. candles (96,900 Lux)
Focal Distance from Front of Engine	Near: 4 cm (1.6 in.) Far: 38 cm (15 in.)
Aiming Element (VLD)	655 nm +/- 10 nm
Illumination Element (LED)	625 nm +/- 5 nm

Table A-1 MC31XX Technical Specifications (Continued)

Item	Description
2D Imager Engine (SE4500-HD) Specifications	
Range on 100% UPCA at 30 ft./candles	Near: 6.65 cm (2.62 in.) Far: 15.49 cm (6.1 in.)
Field of View	Horizontal - 39° Vertical - 25°
Optical Resolution	752 x 480 pixels
Roll	360°
Pitch Angle	+/- 60° from normal
Skew Tolerance	+/- 60° from normal
Ambient Light	9,000 ft. candles (96,900 Lux)
Focal Distance from Front of Engine	Near: 4 cm (1.6 in.) Far: 17 cm (6.8 in.)
Aiming Element (VLD)	655 nm +/- 10 nm
Illumination Element (LED)	625 nm +/- 5 nm
Zebra Interactive Sensor Technology	
Motion-sensor	3-axis accelerometer that enables motion-sensing applications on dynamic screen orientation, power management and free-fall detects

Table A-2 Accessory Technical Specifications

	Single Slot Serial/USB Cradle	Cables	Four Slot Charge Only and Four Slot Ethernet Cradles	Four Slot Spare Battery Charger	Universal Battery Charger (UBC) Adapter
Operating Temperature	32° to 122°F (0° to +50°C)			32° to 104°F (0° to +40°C)	
Storage Temperature	-40° to 158°F (-40° to 70°C)				
Battery Charging Temperature	32° to 104° F (0° to +40° C) ambient temperature				
Humidity	5% to 95% non-condensing				
Size (L x D x H)	4.4 in x 5.7 in x 4.7 in (11.2 cm x 14.5 cm x 12 cm)	6 feet (1.83 m)	18 in x 4 in x 5 in (45.7 cm x 10.1 cm x 12 cm)	8.25 in x 6.0 in x 1.7 in (20.96 cm x 15.24 cm x 4.32 cm)	2.5 in x 6.1 in x 1.5 in (6.4 cm x 15.5 cm x 3.8 cm)

Table A-2 Accessory Technical Specifications (Continued)

	Single Slot Serial/USB Cradle	Cables	Four Slot Charge Only and Four Slot Ethernet Cradles	Four Slot Spare Battery Charger	Universal Battery Charger (UBC) Adapter
Weight	0.60 lbs (0.27 kg)	N/A	Charge only: 2.25 lbs (1.02 kg) Ethernet: 2.38 lbs (1.08 kg)	13.6 oz (386 g)	0.25 lbs (0.11 kg)
Power	12 V, 3.3 A	5.4 V, 3 A	12 V, 9 A	12 V, 3.3 A	15 V, 1.5 A
Drop	30 inches (76.2 centimeter) to vinyl covered concrete				
Electrostatic Discharge (ESD)	+/-15 kV air discharge, +/- 8 kV direct discharge, +/- 8 kV indirect discharge				

Mobile Computer Pin-Outs

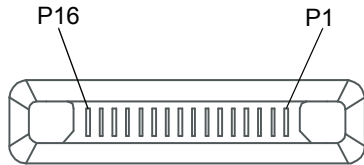

Figure A-1 MC3100 Connector

Table A-3 MC3100 Pin-Outs

PIN Number	Signal Name	Function
1	GND	Ground/Return
2	CRADLE_IN*	When grounded, the mobile computer detects it is in the cradle.
3	DCD	RS232 DCD (into mobile computer)
4	USB_N	USB negative
5	USB_P	USB positive
6	GND	Ground/Return
7	BOTG_VBUS2	USB power out
8	USB_P2_7_SCTR	USB ID
9	U1_TXD_RS232	RS232 TXD (out of mobile computer)
10	U1_RXD_RS232	RS232 RXD (into mobile computer)
11	U1_RTS_RS232	RS232 RTS (out of mobile computer)

Table A-3 MC3100 Pin-Outs (Continued)

PIN Number	Signal Name	Function
12	U1_CTS_RS232	RS232 CTS (into mobile computer)
13	U1_DTR_RS232	RS232 DTR (out of mobile computer)
14	U1_DSR_RS232	RS232 DSR (into mobile computer)
15	VCC5_CAM	5V power to RS232 accessories
16	POWER_JACK_ACC	Power into mobile computer.

Appendix B Special Software Configurations

Battery Usage Threshold Setting

By default the Battery Usage Threshold value is set to a pre-defined value (400 by default). To change the threshold value, a registry key must be created to allow changing this value.

A battery becomes unhealthy when the *Battery Usage Indication* reach a predefined threshold (end of usable life).



NOTE The point at which a battery becomes unhealthy may vary depending upon the environment and charging conditions

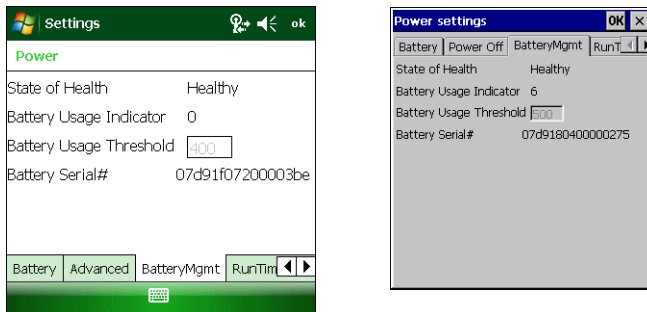

Figure B-1 Power BatteryMgmt Tab

Registry Setting

Create the following registry key:

```
[HKEY_LOCAL_MACHINE\ControlPanel\Power]
```

```
“EnableCycleCntThresholdEdit”=DWORD:0
```

where:

```
 dword:0 = Enable threshold change
```

Warm boot the MC31XX to have the registry setting take effect.

1. Tap **Start** > **Settings** > **Power** > **BatteryMgmt** tab.

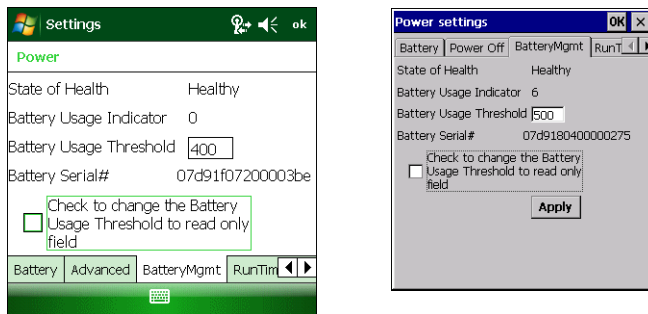

Figure B-2 BatteryMgmt Tab with Threshold Change Checkbox

2. In the **Battery Usage Threshold** text box, enter a new value.
3. Select the **Check to change the Battery Age Threshold to read only field** checkbox.
4. Tap **Apply**.
5. Tap **ok**. The new value is set and then the registry key is deleted.

Bluetooth Configuration Setting

The MC31XX supports both the Microsoft Bluetooth stack and the StoneStreet One Bluetooth stack. Only one Bluetooth stack can be used at a time. By default, the Microsoft Bluetooth stack is enabled. A registry key on the MC31XX can be modified to disable the Microsoft stack and enable the StoneStreet One stack.

Using a registry editor, navigate to the following:

[HKEY_LOCAL_MACHINE\Software\SymbolBluetooth]

Edit the following key:

"SSStack"=dword:1

where:

- 0 = enable Microsoft stack and disable StoneStreet One stack (default)
- 1 = enable StoneStreet One stack and disable Microsoft stack

After setting the registry key, warm boot the MC31XX.

Sample Applications and StartUpCtl Configuration

The MC31XX with Windows CE 6.0 contains a set of sample applications that can be installed on the device. As part of the installation, an application called StartUpCtl is also installed.

On the desktop, double-tap the **Install Samples** icon.

The Sample Applications and StartUpCtl application installs on the device and the Sample Applications window appears.

After a warm or cold boot, the **Sample Applications** window appears automatically.

StartUpCtl Application Configuration

StartUpCtl application can be used to automatically launch any application whenever a warm or cold boot is performed.

Refer to the StartUpCtl instruction available with the StartUpCtl software download available on the Support Central web site: <http://www.zebra.com/support>.

Removing Sample Applications and StartUpCtl Application

To remove the installed applications (before a cold boot is performed):

1. Tap **Start > Setting > Control Panel > Remove Programs** icon.
2. Select **Zebra Samples.C** from the list.
3. Tap the **Remove** button.
4. Tap the **Yes** button.
5. Select **Zebra startUpCtl** from the list.
6. Tap the **Remove** button.
7. Tap the **Yes** button.
8. Tap **OK**.

To remove the installed applications (after a cold boot is performed):

1. Tap **Start > Programs > Windows Explorer**.
2. Open the **Application** folder.
3. Delete the **Sample.C** folder and its contents.
4. Delete the **StartUpCtl** folder and its contents.
5. Delete the **Samples.C** file.
6. Open the **StartUp** folder.
7. Delete the **StartUpCtl** file.

After a cold boot the **Install Samples** icon appears on the desktop.

Appendix C Windows Mobile 6.5

Introduction

This chapter describes the new features in the latest version of the operating system, OEM version, with Windows Mobile 6.5. These include:

- Finger scrolling functionality
- New Home screen
- New Start menu
- New Lock screen
- RS507 support
- Battery Swapping
- USB Configuration.

Finger Scrolling

Windows Mobile 6.5 adds finger scrolling capabilities to the display. Finger scrolling can be used to scroll up and down web pages, documents, and lists such as the contacts list, file list, message list, calendar appointments list, and more.

When finger scrolling, swipe or flick your finger on the screen.

To scroll down, swipe your finger upward on the screen. To scroll up, swipe your finger downward on the screen.

To auto-scroll, flick your finger upward or downward on the screen. Touch the screen to stop scrolling.

Home Screen

The default home screen on the MC3100 is the Windows Mobile Home screen. The Home screen contains a Status Bar at the top of the screen and a Tile Bar at the bottom of the screen.

The Home screen is scrollable and contains a list of application plug-ins and an Information Status bar. The Information Status bar highlights the application plug-in that is under it and provides additional information.



Figure C-1 Windows Mobile Home Screen

Touch and hold the screen with your finger and move the Home screen up and down. As the application names move under the Information Status bar, information relevant to that application appear in the bar.



Figure C-2 Moving Home Screen

You can also touch and hold the Information Status bar and move it up and down over an application name. Remove your finger and the Information Status bar and application name center in the screen.

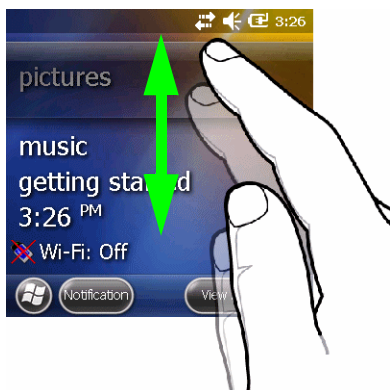

Figure C-3 Moving Information Status Bar

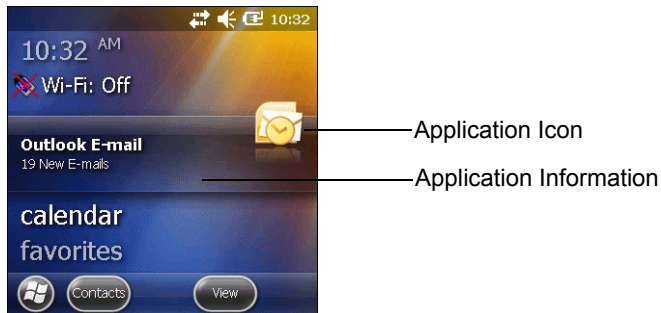

Figure C-4 Information Bar Example

To customize the Home screen, tap > **Settings** > **Home**. On the horizontal scroll, use **Appearance** to customize the background and the **Items** to change the display format.

Classic Today Screen

The user can change to the classic Today screen layout that is used in Windows Mobile 6.1.

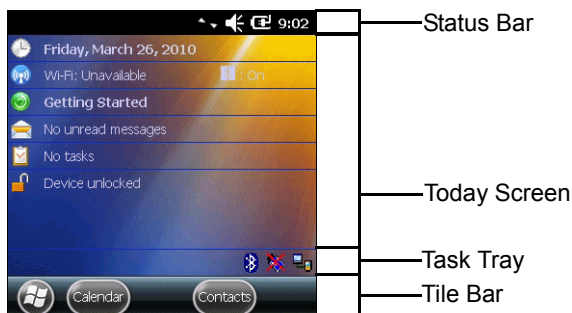

Figure C-5 Classic Today Screen

To change to the classic view tap > **Settings** > **Home** > **Items**.

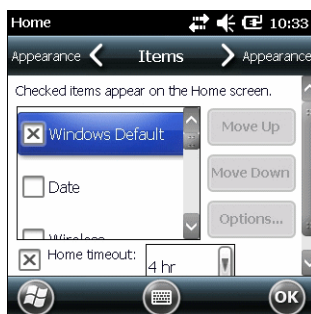







Figure C-6 Home Screen Settings

Deselect the **Windows Default** checkbox and select any of the other checkboxes.

Tap .

The task bar at the bottom of the screen can contain the task tray icons listed in [Table C-1](#).

Table C-1 Task Tray Icons

Icon	Name	Description
	Wireless connection status	Wireless connection status icon. Indicates WLAN signal strength and opens the Wireless Applications menu.
	Bluetooth Enabled	The Bluetooth Enabled icon appears in the task tray and indicates that the Bluetooth radio is on (Displays only if the StoneStreet One Bluetooth stack is enabled).
	Bluetooth Disabled	The Bluetooth Disabled icon appears in the task tray and indicates that the Bluetooth radio is off (Displays only if the StoneStreet One Bluetooth stack is enabled).
	Bluetooth Communication	The Bluetooth Communication icon appears in the task tray and indicates that the mobile computer is communicating with another Bluetooth device (Displays only if the StoneStreet One Bluetooth stack is enabled).
	IST	Opens the IST control panel.
	ActiveSync	The ActiveSync icon appears in the task tray and indicates an active serial connection between the mobile computer and the development computer.

Status Bar

The **Status Bar** at the top of the screen displays the status icons listed in [Table C-2](#).

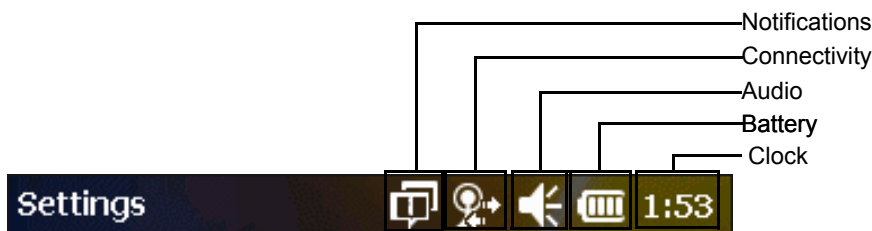

Figure C-7 Status Bar Icons

Table C-2 Status Bar Icons



















Icon	Description	Icon	Description
Notifications			
	Indicates a reminder of an upcoming calendar event.		Notification that one or more instant messages were received.
	Notification that one or more e-mail/text messages were received.		There are more notification icons than can be displayed.

Table C-2 Status Bar Icons (Continued)





Icon	Description	Icon	Description
Connectivity			
	Connection is active.		Connection is not active.
	Synchronization is occurring.		Wi-Fi available.
	Wi-Fi in use.		
Audio			
	All sounds are on.		All sounds are off.
	Vibrate is on.		
Battery			
	Battery is charging.		Battery has a full charge.
	Battery has a high charge.		Battery has a medium charge.
	Battery has a low charge.		Battery has a very low charge.

Tap the Status Bar to display an icon bar. Tap an icon to get additional notification or status information.



Figure C-8 Icon Bar

Table C-3 *Icon Bar Icons*

Icon	Name	Description
	Magnify	Enlarges the screen.
	Connectivity	Displays the Connectivity dialog box.
	Volume	Displays the Volume dialog box.
	Power	Displays the Power window.
	Clock & Alarms	Opens the Clocks & Alarms window.

Tile Bar

The **Tile Bar**, located at the bottom of the screen, contains the **Start** tile  to open the **Start Menu**. It also displays tiles that vary depending upon the open application.

**Figure C-9** *Tile Bar Examples*

Start Screen

To open the **Start** screen, tap  at the bottom left corner of the screen, or press the START key on the keypad.

Swipe upward to view more program and folder icons.

You can move often-used program and folder icons anywhere on the Start screen for easy access. Press and hold the icon that you want to move. Drag the icon to a new location and release.

[Table C-4](#) lists the default icons available on the Start screen.

Table C-4 Programs on the Start Screen























Icon	Name	Description	Icon	Name	Description
	ActiveSync	Synchronize information between the MC3100 and a host computer or the Exchange Server.		Calendar	Keep track of appointments and create meeting requests.
	Contacts	Keep track of friends and colleagues.		File Explorer	Organize and manage files on your device.
	Messenger	Use this mobile version of Windows Live Messenger.		Pictures & Videos	View and manage pictures, animated GIFs, and video files.
	E-mail	Send an Email.		Windows Media Player Mobile	Play back audio and video files.
	Getting Started	Launch the Getting Started application.		Marketplace	Purchase applications from the Marketplace.
	Internet Explorer Mobile	Browse Web and WAP sites as well as download new programs and files from the Internet.		Windows Live	Use this mobile version of Windows Live™ to find information on the web.
	Microsoft My Phone	Synchronizes the MC3100's contacts, calendar, tasks, text messages, music, photos videos and documents with a Microsoft My Phone account.		MSN Money	Keep track of your finances.
	MSN Weather	Check the local weather.		Calculator	Perform basic arithmetic and calculations, such as addition, subtraction, multiplication, and division.
	Games	Play games.		Text	Send an SMS text message.
	Notes	Create handwritten or typed notes, drawings, and voice recordings.		Home	Displays the Home screen.
	Tasks	Keep track of your tasks.		Settings	Opens the Settings folder.

Table C-4 Programs on the Start Screen















Icon	Name	Description	Icon	Name	Description
	Internet Sharing	Connect a notebook computer to the Internet using the MC3100's data connection.		Help	Access on-line Help topics.
	Task Manager	Enables viewing of memory and CPU allocations and stops running processes. Refer to the <i>Microsoft Applications for Windows Mobile 6 User Guide</i> for more information.		Wireless Companion Folder	Open the Wireless Companion folder.
	Search Phone	Search contacts, data, and other information on the MC3100. Refer to the <i>Microsoft Applications for Windows Mobile 6 User Guide</i> for more information.		AirBEAM Client	Allows specially designed software packages to be transferred between a host server and the MC3100. Refer to the <i>MC3100 Integrator Guide</i> for more information.
	BT Information	Display information about the Bluetooth radio and generate a Bluetooth address bar code.		Remote Desktop Mobile	Log onto Windows NT server type computers and use all of the programs that are available on that computer from the MC3100.
	Modem Link	Enables the MC3100 to be used as a modem.		Battery Swap	
	MSP Agent	Interacts with MSP agents to collect monitoring and asset information to enable the configuration, provisioning, monitoring and troubleshooting of the MC3100. Refer to the <i>MC3100 Integrator Guide</i> for more information.		Rapid Deployment Client	Facilitates software downloads from a Mobility Services Platform Console FTP server to the MC3100. Refer to the <i>MC3100 Integrator Guide</i> for more information.

Table C-4 Programs on the Start Screen

Icon	Name	Description	Icon	Name	Description
	Alarms	Set the device clock to the date and time of your locale or to a visiting time zone when you're traveling. Alarms can also be set at specified days and times of a week.		Office Mobile	Use the suite of Microsoft® Office applications for your mobile device; Excel Mobile, OneNote Mobile, PowerPoint Mobile and Word Mobile.
	BTScannerCtl Panel			BTEplorer	Manages StoneStreet One Bluetooth connections.
	SwitchUSB				

Speaker Icon

You can adjust the system volume using the **Speaker** icon.

1. Tap the Status Bar and then tap the **Speaker** icon. The **Volume** dialog box appears.



Figure C-10 Volume Dialog Box

2. Tap and move the slide bar to adjust the volume.
3. Select the **On** or **Off** radio button to turn the volume on or off.

✓ **NOTE** Use can also adjust the system volume using the **Sounds & Notifications** window or by using the keypad.

Battery Icons

The **Battery** icon in the Status Bar indicates the battery power level. To view or change power settings, tap the Status Bar. Tap the BAattery icon to display the **Power** window.

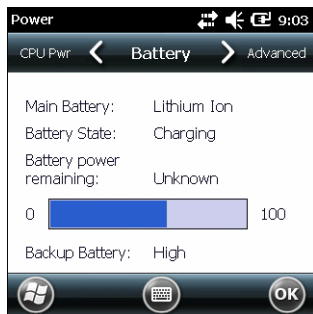

Figure C-11 Power Window

Connectivity Icon

The **Connectivity** icon indicates the communication status of the terminal when it's connecting to the internet or host computer. Tap the Status Bar and then tap the **Connectivity** icon.

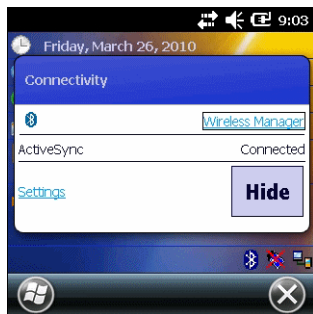

Figure C-12 Connectivity Dialog Box

Clock Icon

The **Clock** icon displays the current time. To change the current time, tap the Status Bar and then tap the **Clock** icon.

Locking the MC3100

You can lock the MC3100 by disabling key presses and screen tap or by requiring a password or finger swipe. There are two types of locking features available; the standard Microsoft lock and the Zebra lock.

✓ **NOTE** You can make emergency calls even when the MC3100 is locked.

Microsoft Locking

Locking the MC3100 turns off keyboard and touch screen functionality. This is helpful when the MC3100 is turned on and you want to prevent accidental key presses.

To lock the device, tap  > .

The lock screen appears.

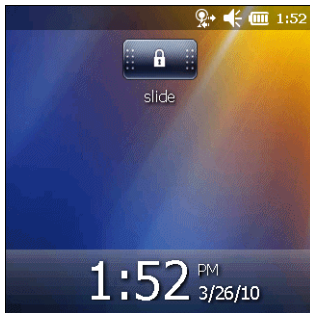



Figure C-13 Lock Screen

Drag  to either the right or left side of the screen.

If a password is set up, enter the password and then tap  to unlock and display the Home screen, tap  to unlock and display the Contacts window, tap  to unlock and display the Messaging window.

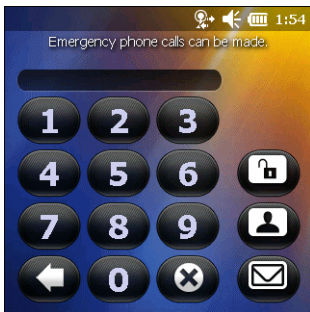

Figure C-14 Password Window

Password Locking

Use the **Password** window to set a password to disable unauthorized access to the MC3100.

- ✓ **NOTE** If the device is configured to connect to a network, use a strong (difficult to figure out) password to help protect network security. Password cracking tools continue to improve and the computers used to crack passwords are more powerful than ever.

1. Tap  > **Settings** > **Lock** > **Password**.

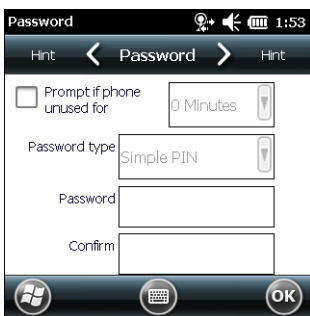





Figure C-15 Password Window

2. Select **Prompt if device unused for** check box to enable password protection.
3. From the drop-down list, select a time value for the protection to take affect after non-use.

4. From the **Password type:** drop-down list, select either **Simple PIN** or **Strong alphanumeric**.
5. For a simple password, enter a four-digit password in the **Password** field.
For a stronger password:
 - a. Enter a seven character password in the **Password:** field. A strong password must contain at least seven characters and contain at least three of the following: uppercase and lowercase letters, numerals, and punctuation.
 - b. Re-enter the password in the **Confirm:** field.
6. Tap .
7. In the horizontal scroll, select **Hint**. Enter a hint to remember the password if you forget it.
8. Tap .
9. In the text box, enter a hint for a password reminder.
10. Tap .

When the MC3100 is not used for a period of time and the user tries to access the device, the Lock window appears.

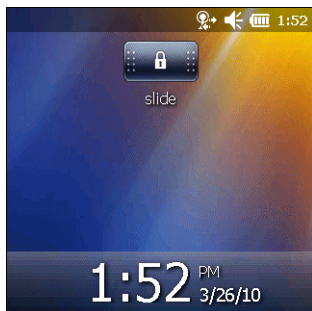

Figure C-16 Lock Window

1. Slide the Lock button to the left or right.
2. Enter the password to un-lock the device.

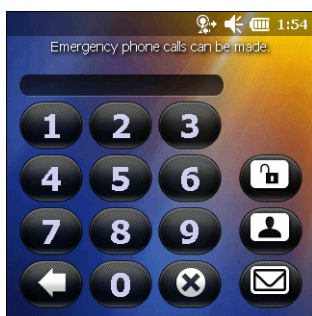

Figure C-17 Enter Password Window

3. Tap the **Unlock** icon.

Using the RS507 Hands-free Imager

An RS507 Hands-free Imager can be used with the MC3100 to capture bar code data.

To set up the RS507:

1. Tap **Start > Programs > BTScannerCtlPanel** icon.
2. If required, select the **BT Scanner** checkbox and then select the appropriate Com port from the drop-down list.
3. Tap **Save and Exit**.
4. Tap **Start > Programs > BD Address** icon. A bar code displays.
5. Point the RS507 to the bar code. The RS507 reads the bar code and begins pairing with the MC55.

Refer to the *RS507 Hands-free Imager Product Reference Guide* for more information.

Removing the Battery

OEM version 02.27.000 provides an application that assists when suspending the MC3100 or when removing the battery.

Battery Removal

To remove the battery:

1. If the MC3100 is in suspend mode, press the red Power button to wake the device.
2. Press the red Power button to suspend the MC3100. The **Power Key Action** screen appears.

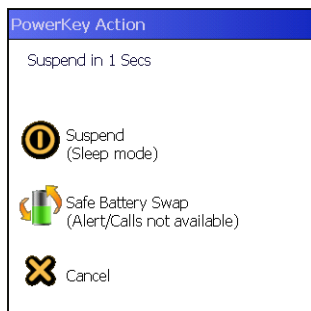

Figure C-18 *PowerKey Action Window*

3. Tap **Safe Battery Swap** icon.
4. Wait for the red decode LEDs to turn on and then turn off.
5. Remove the battery.

Suspend Mode

To place the MC3100 in suspend mode:

1. Press the red Power button to suspend the MC3100. The **Power Key Action** screen appears.



Figure C-19 *PowerKey Action Window*

2. Tap **Suspend** icon.
3. The MC3100 goes into suspend mode.

USB Configuration

The MC3100 can be placed into any of the following USB modes:

- USB Client
- USB Host
- USB On-the-Go.

To place the MC3100 into one of these modes:

1. Tap **Start > Settings > System > USBConfig**.
2. Select one of the radio buttons.
3. Tap .

Glossary

Numeric

802.11/802.11abg. A radio protocol that may be used by the Zebra radio card.

A

Access Point. Access Point (AP) refers to Zebra's Ethernet Access Point. It is a piece of communications equipment that manages communications between the host computer system and one or more wireless terminals. An AP connects to a wired Ethernet LAN and acts as a bridge between the Ethernet wired network and IEEE 802.11 interoperable radio-equipped mobile units, such as a mobile computer. The AP allows a mobile user to roam freely through a facility while maintaining a seamless connection to the wired network.

AirBEAM® Manager. AirBEAM® Manager is a comprehensive wireless network management system that provides essential functions that are required to configure, monitor, upgrade and troubleshoot the wireless network and its components (including networked mobile computers). Some features include event notification, access point configuration, diagnostics, statistical reports, auto-discovery, wireless proxy agents and monitoring of access points and mobile units.

AirBEAM® Smart Client. AirBEAM® Smart Client is part of Zebra's AirBEAM® suite, which also includes AirBEAM® Safe and AirBEAM® Manager. The AirBEAM® Smart Client system uses the network accessible host server to store software files that are to be downloaded to the mobile computers. The AirBEAM® Smart Client provides the mobile computers with the "smarts" to request software from the host. It allows them to request, download and install software, as well as to upload files and status data. The AirBEAM® Smart Client uses the industry standard FTP or TFTP file transfer protocols to check the host system for updates, and if necessary, to transfer updated software. Most often, AirBEAM® Smart Client is used with wireless networks, but any TCP/IP connection can be used. For more information, refer to the AirBEAM® Smart Windows® CE Client Product Reference Guide (p/n 72-63060-xx).

AP. See **Access Point**.

Aperture. The opening in an optical system defined by a lens or baffle that establishes the field of view.

ASCII. American Standard Code for Information Interchange. A 7 bit-plus-parity code representing 128 letters, numerals, punctuation marks and control characters. It is a standard data transmission code in the U.S.

Autodiscrimination. The ability of an interface controller to determine the code type of a scanned bar code. After this determination is made, the information content is decoded.

B

Bar. The dark element in a printed bar code symbol.

Bar Code. A pattern of variable-width bars and spaces which represents numeric or alphanumeric data in machine-readable form. The general format of a bar code symbol consists of a leading margin, start character, data or message character, check character (if any), stop character, and trailing margin. Within this framework, each recognizable symbology uses its own unique format. See **Symbology**.

Bar Code Density. The number of characters represented per unit of measurement (e.g., characters per inch).

Bar Height. The dimension of a bar measured perpendicular to the bar width.

Bar Width. Thickness of a bar measured from the edge closest to the symbol start character to the trailing edge of the same bar.

Bit. Binary digit. One bit is the basic unit of binary information. Generally, eight consecutive bits compose one byte of data. The pattern of 0 and 1 values within the byte determines its meaning.

Bits per Second (bps). Bits transmitted or received.

Bit. Binary digit. One bit is the basic unit of binary information. Generally, eight consecutive bits compose one byte of data. The pattern of 0 and 1 values within the byte determines its meaning.

bps. See **Bits Per Second**.

Byte. On an addressable boundary, eight adjacent binary digits (0 and 1) combined in a pattern to represent a specific character or numeric value. Bits are numbered from the right, 0 through 7, with bit 0 the low-order bit. One byte in memory is used to store one ASCII character.

boot or boot-up. The process a computer goes through when it starts. During boot-up, the computer can run self-diagnostic tests and configure hardware and software.

C

CDRH. Center for Devices and Radiological Health. A federal agency responsible for regulating laser product safety. This agency specifies various laser operation classes based on power output during operation.

CDRH Class 1. This is the lowest power CDRH laser classification. This class is considered intrinsically safe, even if all laser output were directed into the eye's pupil. There are no special operating procedures for this class.

CDRH Class 2. No additional software mechanisms are needed to conform to this limit. Laser operation in this class poses no danger for unintentional direct human exposure.

Character. A pattern of bars and spaces which either directly represents data or indicates a control function, such as a number, letter, punctuation mark, or communications control contained in a message.

Character Set. Those characters available for encoding in a particular bar code symbology.

Check Digit. A digit used to verify a correct symbol decode. The scanner inserts the decoded data into an arithmetic formula and checks that the resulting number matches the encoded check digit. Check digits are required for UPC but are optional for other symbologies. Using check digits decreases the chance of substitution errors when a symbol is decoded.

Codabar. A discrete self-checking code with a character set consisting of digits 0 to 9 and six additional characters: (“-”, “\$”, “:”, “/”, “,” and “+”).

Code 128. A high density symbology which allows the controller to encode all 128 ASCII characters without adding extra symbol elements.

Code 3 of 9 (Code 39). A versatile and widely used alphanumeric bar code symbology with a set of 43 character types, including all uppercase letters, numerals from 0 to 9 and 7 special characters (“-”, “:”, “/”, “+”, “%”, “\$” and space). The code name is derived from the fact that 3 of 9 elements representing a character are wide, while the remaining 6 are narrow.

Code 93. An industrial symbology compatible with Code 39 but offering a full character ASCII set and a higher coding density than Code 39.

Code Length. Number of data characters in a bar code between the start and stop characters, not including those characters.

Cold Boot. A cold boot restarts the mobile computer and erases all user stored records and entries.

COM port. Communication port; ports are identified by number, e.g., COM1, COM2.

Continuous Code. A bar code or symbol in which all spaces within the symbol are parts of characters. There are no intercharacter gaps in a continuous code. The absence of gaps allows for greater information density.

Cradle. A cradle is used for charging the terminal battery and for communicating with a host computer, and provides a storage place for the terminal when not in use.

D

Dead Zone. An area within a scanner's field of view, in which specular reflection may prevent a successful decode.

Decode. To recognize a bar code symbology (e.g., UPC/EAN) and then analyze the content of the specific bar code scanned.

Decode Algorithm. A decoding scheme that converts pulse widths into data representation of the letters or numbers encoded within a bar code symbol.

Decryption. Decryption is the decoding and unscrambling of received encrypted data. Also see, **Encryption** and **Key**.

Depth of Field. The range between minimum and maximum distances at which a scanner can read a symbol with a certain minimum element width.

Discrete Code. A bar code or symbol in which the spaces between characters (intercharacter gaps) are not part of the code.

Discrete 2 of 5. A binary bar code symbology representing each character by a group of five bars, two of which are wide. The location of wide bars in the group determines which character is encoded; spaces are insignificant. Only numeric characters (0 to 9) and START/STOP characters may be encoded.

E

EAN. European Article Number. This European/International version of the UPC provides its own coding format and symbology standards. Element dimensions are specified metrically. EAN is used primarily in retail.

Element. Generic term for a bar or space.

EMDK. Developer's Kit.

Encoded Area. Total linear dimension occupied by all characters of a code pattern, including start/stop characters and data.

ESD. Electro-Static Discharge

ESN. Electronic Serial Number. The unique hardware number associated with a cellular device, which is transmitted to the system when the device communicates with the cellular system.

Ethernet. Ethernet communication port. Allows a wired interface to a radio network.

F

Flash Memory. Flash memory is nonvolatile, semi-permanent storage that can be electronically erased in the circuit and reprogrammed. Some mobile computers use Flash memory to store the operating system (ROM-DOS), the terminal emulators, and the Citrix ICA Client for DOS.

FTP. See **File Transfer Protocol**.

Flash Memory. Flash memory is responsible for storing the system firmware and is non-volatile. If the system power is interrupted the data is not be lost.

G

Gateway Address. An IP address for a network gateway or router. A mobile computer may be part of a subnet as specified by its IP address and Netmask. It can send packets directly to any node on the same subnet. If the destination node is on a different subnet, then the terminal sends the packet to the gateway first. The gateway determines how to route the packet to the destination subnet. This field is an option used by networks that require gateways.

H

Hard Reset. See **Cold Boot**.

Hz. Hertz; A unit of frequency equal to one cycle per second.

Host Computer. A computer that serves other terminals in a network, providing such services as computation, database access, supervisory programs and network control.

I

IDE. Intelligent drive electronics. Refers to the solid-state hard drive type.

IEC. International Electrotechnical Commission. This international agency regulates laser safety by specifying various laser operation classes based on power output during operation.

IEC (825) Class 1. This is the lowest power IEC laser classification. Conformity is ensured through a software restriction of 120 seconds of laser operation within any 1000 second window and an automatic laser shutdown if the scanner's oscillating mirror fails.

Interleaved 2 of 5. A binary bar code symbology representing character pairs in groups of five bars and five interleaved spaces. Interleaving provides for greater information density. The location of wide elements (bar/spaces) within each group determines which characters are encoded. This continuous code type uses no intercharacter spaces. Only numeric (0 to 9) and START/STOP characters may be encoded.

imaging scanning . Mobile computers with an integrated imager use digital camera technology to take a digital picture of a bar code, store the resulting image in memory and execute state-of-the-art software decoding algorithms to extract the data from the image.

Intercharacter Gap. The space between two adjacent bar code characters in a discrete code.

Interleaved Bar Code. A bar code in which characters are paired together, using bars to represent the first character and the intervening spaces to represent the second.

Interleaved 2 of 5. A binary bar code symbology representing character pairs in groups of five bars and five interleaved spaces. Interleaving provides for greater information density. The location of wide elements (bar/spaces) within each group determines which characters are encoded. This continuous code type uses no intercharacter spaces. Only numeric (0 to 9) and START/STOP characters may be encoded.

Internet Protocol Address. See **IP**.

IP. Internet Protocol. The IP part of the TCP/IP communications protocol. IP implements the network layer (layer 3) of the protocol, which contains a network address and is used to route a message to a different network or subnetwork. IP accepts "packets" from the layer 4 transport protocol (TCP or UDP), adds its own header to it and delivers a "datagram" to the layer 2 data link protocol. It may also break the packet into fragments to support the maximum transmission unit (MTU) of the network.

IP Address. (Internet Protocol address) The address of a computer attached to an IP network. Every client and server station must have a unique IP address. A 32-bit address used by a computer on a IP network. Client workstations have

either a permanent address or one that is dynamically assigned to them each session. IP addresses are written as four sets of numbers separated by periods; for example, 204.171.64.2.

L

LAN. Local area network. A radio network that supports data communication within a local area, such as within a warehouse of building.

laser scanner. A type of bar code reader that uses a beam of laser light.

LASER. Light Amplification by Stimulated Emission of Radiation. The laser is an intense light source. Light from a laser is all the same frequency, unlike the output of an incandescent bulb. Laser light is typically coherent and has a high energy density.

Laser Diode. A gallium-arsenide semiconductor type of laser connected to a power source to generate a laser beam. This laser type is a compact source of coherent light.

LED Indicator. A semiconductor diode (LED - Light Emitting Diode) used as an indicator, often in digital displays. The semiconductor uses applied voltage to produce light of a certain frequency determined by the semiconductor's particular chemical composition.

Light Emitting Diode. See **LED**.

M

MC. Mobile Computer.

MIL. 1 mil = 1 thousandth of an inch.

MIN. Mobile Identification Number. The unique account number associated with a cellular device. It is broadcast by the cellular device when accessing the cellular system.

Misread (Misdecode). A condition which occurs when the data output of a reader or interface controller does not agree with the data encoded within a bar code symbol.

Mobile Computer. In this text, *mobile computer* refers to the Zebra wireless handheld computer. It can be set up to run as a stand-alone device, or it can be set up to communicate with a network, using wireless radio technology.

N

Nominal. The exact (or ideal) intended value for a specified parameter. Tolerances are specified as positive and negative deviations from this value.

Nominal Size. Standard size for a bar code symbol. Most UPC/EAN codes are used over a range of magnifications (e.g., from 0.80 to 2.00 of nominal).

NVM. Non-Volatile Memory.

P

Parameter. A variable that can have different values assigned to it.

PDT. Portable Data Terminal.

Percent Decode. The average probability that a single scan of a bar code would result in a successful decode. In a well-designed bar code scanning system, that probability should approach near 100%.

Q

Quiet Zone. A clear space, containing no dark marks, which precedes the start character of a bar code symbol and follows the stop character.

R

RAM. Random Access Memory. Data in RAM can be accessed in random order, and quickly written and read.

Reflectance. Amount of light returned from an illuminated surface.

Resolution. The narrowest element dimension which is distinguished by a particular reading device or printed with a particular device or method.

RF. Radio Frequency.

ROM. Read-Only Memory. Data stored in ROM cannot be changed or removed.

ROM-DOS. The name of the licensed Disk Operating System loaded into the terminal's flash file system.

Router. A device that connects networks and supports the required protocols for packet filtering. Routers are typically used to extend the range of cabling and to organize the topology of a network into subnets. See **Subnet**.

RS232. An Electronic Industries Association (EIA) standard that defines the connector, connector pins, and signals used to transfer data serially from one device to another.

S

Scan Area. Area intended to contain a symbol.

Scanner. An electronic device used to scan bar code symbols and produce a digitized pattern that corresponds to the bars and spaces of the symbol. Its three main components are:

1. Light source (laser or photoelectric cell) - illuminates a bar code.
2. Photodetector - registers the difference in reflected light (more light reflected from spaces).
3. Signal conditioning circuit - transforms optical detector output into a digitized bar pattern.

Scanning Mode. The scanner is energized, programmed and ready to read a bar code.

Scanning Sequence. A method of programming or configuring parameters for a bar code reading system by scanning bar code menus.

SDK. Software Development Kit

Self-Checking Code. A symbology that uses a checking algorithm to detect encoding errors within the characters of a bar code symbol.

Shared Key. Shared Key authentication is an algorithm where both the AP and the MU share an authentication key.

SID. System Identification code. An identifier issued by the FCC for each market. It is also broadcast by the cellular carriers to allow cellular devices to distinguish between the home and roaming service.

Soft Reset. See **Warm Boot.**

Space. The lighter element of a bar code formed by the background between bars.

Specular Reflection. The mirror-like direct reflection of light from a surface, which can cause difficulty decoding a bar code.

Start/Stop Character. A pattern of bars and spaces that provides the scanner with start and stop reading instructions and scanning direction. The start and stop characters are normally to the left and right margins of a horizontal code.

STEP. Symbol Terminal Enabler Program.

Subnet. A subset of nodes on a network that are serviced by the same router. See **Router.**

Subnet Mask. A 32-bit number used to separate the network and host sections of an IP address. A custom subnet mask subdivides an IP network into smaller subsections. The mask is a binary pattern that is matched up with the IP address to turn part of the host ID address field into a field for subnets. Default is often 255.255.255.0.

Substrate. A foundation material on which a substance or image is placed.

SVTP. Symbol Virtual Terminal Program.

Symbol. A scannable unit that encodes data within the conventions of a certain symbology, usually including start/stop characters, quiet zones, data characters and check characters.

Symbol Aspect Ratio. The ratio of symbol height to symbol width.

Symbol Height. The distance between the outside edges of the quiet zones of the first row and the last row.

Symbol Length. Length of symbol measured from the beginning of the quiet zone (margin) adjacent to the start character to the end of the quiet zone (margin) adjacent to a stop character.

Symbology. The structural rules and conventions for representing data within a particular bar code type (e.g. UPC/EAN, Code 39, PDF417, etc.).

T

Tolerance. Allowable deviation from the nominal bar or space width.

U

UPC. Universal Product Code. A relatively complex numeric symbology. Each character consists of two bars and two spaces, each of which is any of four widths. The standard symbology for retail food packages in the United States.

V

Visible Laser Diode (VLD). A solid state device which produces visible laser light.

W

WAN. Wide-Area Network. A radio network that supports data communication beyond a local area. That is, information can be sent across a city, state, or even nationwide.

Warm Boot. A warm boot restarts the mobile computer by closing all running programs. All data that is not saved to flash memory is lost.

Wireless Local Area Network (WLAN). See **LAN**.

Wireless Wide Area Network (WWAN). See **WAN**.

WNMP. (Wireless Network Management Protocol) This is a proprietary MAC layer protocol used for inter access point communication and other MAC layer communication.

Index

A

accessories	1-1
four slot charge only cradle	2-8
battery charging	2-8
LED indicators	2-9
setup	2-8
troubleshooting	8-7, 8-8
four slot Ethernet cradle	2-10
four slot spare battery charger	
battery charging	2-17
LED indicators	2-18
setup	2-17
troubleshooting	8-9
MC3000 communication/charge cables	
battery charging	2-20
LED indicators	2-20
setup	2-20
troubleshooting	8-10
SD card	1-6
single slot serial/USB cradle	2-4
battery charging	2-5
communication setup	2-7
LED indicators	2-6
setup	2-5
troubleshooting	8-7
stylus	2-3
UBC adapter	
battery charging	2-21
LED indicators	2-22
setup	2-21
troubleshooting	8-9
ActiveSync	xvi, 3-1, C-7
icon	C-4
installing	3-1
setting up a connection	3-3
adding programs	

from Internet	4-8, 5-10
using BootLoader	4-10, 4-12
AirBEAM	C-8
application deployment	4-1, 5-1
application folder	5-8
application packaging	4-1, 5-6
application security	5-1
attaching handstrap	1-18

B

battery	
charging	1-8
temperature range	1-8, A-5
installing	1-6
battery chargers	
four slot spare battery charger	
battery charging	2-17
LED indicators	2-18
MC3000 communication/charge cables	
battery charging	2-20
LED indicators	2-20
UBC adapter	
battery charging	2-21
LED indicators	2-22
battery charging	
backup battery	1-8
four slot charge only cradle	2-8
four slot spare battery charger	2-17
MC3000 communication/charge cables	2-20
UBC adapter	2-21
battery icon	C-5
bluetooth	
communicating icon	C-4
disabled icon	C-4
enabled icon	C-4
boot	

clean	1-13
cold	1-12
warm	1-12
BootLoader	4-5, 4-6
error messages	4-15
bullets	xv

C

CAB files	5-4
deployment via image update	4-9, 5-11
cables	2-19
communication setup	2-20
setup	2-20
troubleshooting	8-10
cache disk	5-8
calculator	C-7
calendar	C-7
calibrating the screen	1-10
calibration screen	1-10
certificates	5-3
charge LED indicator	1-2, 1-4
charging	
backup battery	1-8
battery	1-8
spare batteries	1-9
temperature range	1-8, A-5
clean boot	1-13
cleaning	8-1
cold boot	1-12
command bar	
icons	C-4
communication	2-24
communication setup	
MC3000 communication/charge cables	2-20
single slot serial/USB cradle	2-7
communication/charge cables	
communication setup	2-20
setup	2-20
troubleshooting	8-10
configuration	xii
connector	A-6
Contacts	C-7
contacts	C-7
conventions	
notational	xv
copyfile	5-5
cpf file	5-4
cradle mounting bracket	2-14
cradles	
communication setup	2-7
Ethernet drivers	2-10, 2-11
four slot charge only cradle	2-8
battery charging	2-8

LED indicators	2-9
setup	2-8
four slot Ethernet	2-10
charging	2-12
charging indicators	2-13
setup	2-10
single slot serial/USB cradle	2-4
battery charging	2-5
LED indicators	2-6
setup	2-5
troubleshooting	8-9
creating a splash screen	4-17, 5-12
creating cpf file	5-4

D

data capture	xii
DCP	4-1, 5-6
deployment	4-1, 5-1
Device Configuration Package, see DCP	
digital signatures	5-1
display	xii
documentation updates	xvi

E

electro-static discharge	
EMDK	4-1, 4-2, 5-6, 5-7
error messages	4-15
ESD	1-6

F

fabric holster	2-4
file explorer	C-7
file update	4-6
flash file system	4-4
copyfile	5-5
downloading partitions	4-6
non-FFS partitions	4-5
BootLoader	4-5
splash screen	4-5
partitions	4-4
copyfile	4-5
regmerge	4-4
regmerge	5-5
flash storage	4-4
four slot charge only cradle	2-1, 2-8
battery charging	2-8
LED indicators	2-9
setup	2-8
troubleshooting	8-7, 8-8
four slot Ethernet cradle	2-1, 2-10
charging	2-12

charging indicators	2-13
drivers	2-10, 2-11
setup	2-10
four slot spare battery charger	2-1
battery charging	2-17
LED indicators	2-18
setup	2-17
troubleshooting	8-9

H

handstrap	
attaching	1-18
handstrap removal	1-18
hard reset	1-11, 1-12, 1-13
headset jack	1-3
holster, fabric	2-4
holster, plastic	2-4

I

icon bar icons	C-6
icons	
ActiveSync	C-4
battery	C-5
bluetooth communicating	C-4
bluetooth disabled	C-4
bluetooth enabled	C-4
icon bar	C-6
status	C-4
task tray	C-4
wireless applications	C-4
wireless status	C-4
image update	
deploying CAB files	4-9, 5-11
indicator LED bar	1-2, 1-4
information, service	xvi
installation	
communication	2-24
development tools	4-3, 5-7
Internet Explorer Mobile	C-7
internet sharing	C-8

K

keypads	xii
---------	-----

L

LED charge indicators	1-9
locking EDA	5-2
locking the MC9500-K keypad	C-10

M

main battery	
charging	1-6
temperature range	1-8, A-5
inserting	1-6
installing	1-6
maintenance	8-1
MC3000 communication/charge cables	2-19
battery charging	2-20
communication setup	2-20
LED indicators	2-20
setup	2-20
troubleshooting	8-10
MC3000 connector	A-6
MC3000R parts	1-3
MC3000S parts	1-3
Media Player	C-7
memory	xii
messaging	C-7
microphone	1-2
mobile computer	
cold boot	1-12, 1-13
hard reset	1-11, 1-12
reset	1-11
soft reset	1-11
starting	1-10
warm boot	1-11, 1-12
Monarch printer cable	2-2, 2-19
mounting bracket for cradle	2-14
MSP Agent	C-8

N

navigation bar	
icons	C-4
notes	C-7

O

O'Neil printer cable	2-2, 2-19
operating	
environment	A-1
operating system	xii

P

packaging	4-1, 5-6
partition update	4-6
partitions	
downloading	4-6
FFS	4-4
non-FFS	4-5
BootLoader	4-5

- splash screen 4-5
- parts 1-2, 1-3, 1-4, 1-5
- passwords C-11
- persistent storage 5-8
- pictures C-7
- pin-outs A-6
 - mobile computer A-6
- plastic holster 2-4
- Platform SDK 4-2
- platform SDK xv
- power supply 2-2
- programs
 - adding from Internet 4-8, 5-10
 - adding using BootLoader 4-10, 4-12
 - flash file system 4-4
- provisioning 4-16, 5-12
- PSDK 4-1

R

- radios xii
- RAM 5-7
- random access memory 5-7
- RAPI 5-3
- rapid deployment C-8
- receiver 1-2
- regmerge 5-5
- RegMerge.dll 4-4
- remote API 5-3
- remove battery 1-15, 1-16
- remove the handstrap 1-18
- reset
 - hard 1-12, 1-13
 - soft 1-12
- resetting 1-11
- rotating scan head 1-2
- rotating scan turret 1-3
- RS232 charge cable 2-2, 2-19

S

- scan buttons 1-2, 1-4
- scan LED indicators 1-2, 1-4
- scan window 1-3
- screen
 - calibration 1-10
- SD card 1-6
 - installation 1-6
- secure device card 1-6
- security 5-1
 - application 5-1
 - certificates 5-3
 - device management 5-3
 - digital signatures 5-1

- locking device 5-2
- remote API 5-3
- serial charge cable 2-19
- service information xvi
- setting up a partnership
 - partnership 3-4
- setup
 - four slot charge only cradle 2-8
 - four slot spare battery charger 2-17
 - MC3000 communication/charge cables 2-20
 - single slot serial/USB cradle 2-5
 - UBC adapter 2-21
- single slot cradle RS232 cable 2-2
- single slot cradle USB cable 2-2
- single slot serial/USB cradle 2-1, 2-4
 - battery charging 2-5
 - communication setup 2-7
 - LED indicators 2-6
 - setup 2-5
 - troubleshooting 8-7
- soft reset 1-11, 1-12
- software installation 4-16, 5-12
 - BootLoader 4-10, 4-12
- spare battery
 - charging 1-9
- splash screen 1-10, 4-5
 - creating 4-17, 5-12
- starting the mobile computer 1-6, 1-10
- status icon C-4
 - battery C-5
- storage 5-7
 - application folder 5-8
 - cache disk 5-8
 - persistent 5-8
 - volatile 5-8
- strap/door assembly 1-3, 1-4
- stylus 1-3, 1-10, 2-3
- stylus holder 1-3

T

- task tray icons C-3
- tasks C-7
- technical specifications A-1
- temperature A-2
 - battery charging A-5
- troubleshooting 8-5
 - cables 8-10
 - four slot charge only cradle 8-7, 8-8
 - four slot spare battery charger 8-9
 - mobile computer 8-5
 - single slot serial/USB cradle 8-7
 - UBC adapter 8-9

U

UBC adapter	2-1
battery charging	2-21
LED indicators	2-22
setup	2-21
troubleshooting	8-9
universal battery charger adapter	2-1
unpacking	1-1
updates, documentation	.xvi
USB client charge cable	2-2, 2-19

V

videos	C-7
volatile storage	5-8

W

wakeup conditions	1-13
wall mount bracket	2-14
warm boot	1-11, 1-12
Windows Live	C-7
Windows Live Messenger	C-7
Wireless	6-3
Wireless Manager	6-3
wireless status	C-4
WLAN 802.11a/b/g	xii
WPAN Bluetooth	xii

X

XML provisioning	5-4
certificates	5-3

Z

Zebra printer cable	2-2, 2-19
---------------------	-----------



Zebra Technologies Corporation
Lincolnshire, IL U.S.A.
<http://www.zebra.com>

Zebra and the Zebra head graphic are registered trademarks of ZIH Corp. The Symbol logo is a registered trademark of Symbol Technologies, Inc., a Zebra Technologies company.

© 2015 Symbol Technologies, Inc.