

METTLER TOLEDO Weight/price scales 8442

NETWORK

User manual



METTLER TOLEDO

INTRODUCTION

Your new 8442 unit is among the finest precision digital computing scales available. It is simple to use and requires minimum maintenance. These scales come from a proud tradition that has made METTLER TOLEDO the worldwide symbol of the highest quality in precision weighing equipment.

Please read these instructions carefully. You will find operating the unit is very simple. In the unlikely event you should experience difficulties, contact your authorized METTLER TOLEDO SERVICE OFFICE listed in the yellow pages of your telephone directory.

Properly used and maintained, your new scale will provide years of accurate weighing which will protect your profits and your customers. Please handle your scale as you would any fine electronic equipment.

FCC Notice

This device complies with Part 15 of the FCC Rules and the Radio Interference Requirements of the Canadian Department of Communications. Operation is subject to the following conditions: (1) this device may not cause harmful interference, and (2) this device must accept any interference received, including interference that may cause undesired operation.

This equipment has been tested and found to comply with the limits for a Class A digital device, pursuant to Part 15 of FCC Rules. These limits are designed to provide reasonable protection against harmful interference when the equipment is operated in a commercial environment. This equipment generates, uses, and can radiate radio frequency energy and, if not installed and used in accordance with the instruction manual, may cause harmful interference to radio communications. Operation of this equipment in a residential area is likely to cause harmful interference in which case the user will be required to correct the interference at his own expense.

©Mettler-Toledo, Inc. 2000

No part of this manual may be reproduced or transmitted in any form or by any means, electronic or mechanical, including photocopying and recording, for any purpose without the express written permission of Mettler-Toledo, Inc.



U.S. Government Restricted Rights: This documentation is furnished with Restricted Rights.

**METTLER TOLEDO RESERVES THE RIGHT TO MAKE REFINEMENTS OR
CHANGES WITHOUT NOTICE.**

PRECAUTIONS

READ this manual BEFORE operating or servicing this equipment.

FOLLOW these instructions carefully.

	 WARNING
	<p>ONLY PERMIT QUALIFIED PERSONNEL TO SERVICE THIS EQUIPMENT. EXERCISE CARE WHEN MAKING CHECKS, TESTS AND ADJUSTMENTS THAT MUST BE MADE WITH POWER ON. FAILING TO OBSERVE THESE PRECAUTIONS CAN RESULT IN BODILY HARM.</p>

SAVE this manual for future reference.

	 WARNING
	<p>FOR CONTINUED PROTECTION AGAINST SHOCK HAZARD CONNECT TO PROPERLY GROUNDED OUTLET ONLY. DO NOT REMOVE THE GROUND PRONG.</p>

DO NOT allow untrained personnel to operate, clean, inspect, maintain, service, or tamper with this equipment.

	 WARNING
	<p>DISCONNECT ALL POWER TO THIS UNIT BEFORE INSTALLING, SERVICING, CLEANING, OR REMOVING THE FUSE. FAILURE TO DO SO COULD RESULT IN BODILY HARM AND/OR PROPERTY DAMAGE.</p>

ALWAYS DISCONNECT this equipment from the power source before cleaning or performing maintenance.

 CAUTION
<p>BEFORE CONNECTING/DISCONNECTING ANY INTERNAL ELECTRONIC COMPONENTS OR INTERCONNECTING WIRING BETWEEN ELECTRONIC EQUIPMENT ALWAYS REMOVE POWER AND WAIT AT LEAST THIRTY (30) SECONDS BEFORE ANY CONNECTIONS OR DISCONNECTIONS ARE MADE. FAILURE TO OBSERVE THESE PRECAUTIONS COULD RESULT IN DAMAGE TO OR DESTRUCTION OF THE EQUIPMENT OR BODILY HARM.</p>

CALL METTLER TOLEDO for parts, information, and service.

 CAUTION
<p>OBSERVE PRECAUTIONS FOR HANDLING ELECTROSTATIC SENSITIVE DEVICES.</p>



















Contents

Generalities	5
Keyboard	5
Programming membrane	5
Preparatory actions	7
Presentation of the "DATA ENTRY" menu	7
PLU definition	8
Price change	9
Define presets	10
Tare entry	11
Vendor preset key configuration	12
Increase/decrease key configuration	13
Instructions for special offers	14
Choice the print paper(ticket or label)	15
Sales mode	16
Mode switching	16
Register(with printing on customer ticket)	17
Void	18
Register(with printing on label)	18
Tare	19
Turn on and off the backlight of display	19
Prepacking	20
Select the prepacking mode	20
Procedure	20
Large sales mode	21
Maintenance	22
Replacing the thermal paper roll	22
Cleaning the print head	22
Appendix A: Network configuration	23
Appendix B: Error message	25
Appendix C: Fonts table	27





Generalities

Keyboard

Meaning of the function keys



	Free entry of a price per piece		Continue
	Vendor, clerk		Go back
	Numeric keypad		Tare
	Clear		Zero
	Customer total		Code and switching
	Manual entry of a price per piece to add		Mode and switching
	Manual entry of a price per piece to subtract		Paper feed
	Multiplication		
	Fixed unit price / fixed tare		
	Change back		
	Void		

Special functions keys

	to		preset key
	to		vender key
			increase/decrease key

Note:For type 8442-XX10 or 8442-XX10H, the left 77 keys are preset keys which can store 154 PLUs, V2-V4 are vender keys,[Discount] is increase/decrease key.















Remark :

* to  can be configured as preset key or vender key ,but one function is available at one time.

* can be configured as preset key or vender key or increase/decrease key ,but only one function is available at one time.

Programming membrane

Meaning of the 'programming" keyboard keys.

-  Go to beginning of text
-  Go to end of text
-  move the cursor one position left in the text edit mode
-  move the cursor one position right in the text edit mode
-  Go to next sub-menu
-  Return to previous sub-menu
-  get upper case characters in text edit mode
or select a key's 2nd function
-  Alternate : special characters in text edit mode
-  Select font size
-  Backspace (delete the character left of the cursor)
-  Delete (delete the character on the cursor)
-  Insert (insert a character on the cursor)
-  Centerize the text in text edit mode
-  Carriage return (next line)
-  Selection of a menu

Preparatory actions





Presentation of the "DATA ENTRY" menu

 CODE 1 * Call the "DATA ENTRY" menu



Select desired menu with ↓ ↑ or enter preset code and activate with * key.

PLU definition

    Call the "DATA ENTRY" menu

DATA ENTRY

↓

02 CREATE PLU

*

→ **PLU NUMBER** 0

↓

ART. NO. 0

↓

ENTER TEXT 1

↓

ENTER TEXT 2

↓

ARTICLEGROUP 0

↓

UNITPRICE 0,00

↓

VAT NUMBER 0

↓

TARE NUMBER 0

↓

BEST BEF.OFFSET 0

↓

SELL BY OFFSET 0

↓

PIECE NO 0/1

↓

FIX WEIGHT 0

↓

NO INCREASE/DECREASE 0/1

↓

FREE PRICE NO 0/1

↓

CODE CODE

0,00 0,00 0,00

Press the  key twice or enter the preset code 02.

Enter the PLU number.(1~999999)

Enter the article number (up to 13 figures).

Enter the commodity text 1(up to 70 characters)

Enter the commodity text 2(up to 70 characters)

Enter the article group number.(1~20)

Enter the unitprice.(0~9999.99)

0=no vat
1~8=vat number

0=no tare
1~16=tare number

Input the days of BEST BEFORE

Input the days of SELL BY

Is it an article per piece or a weighed article ?
0 = weighed article
1 = article per piece

Input the FIX WEIGHT for article per piece





0=no increase/decrease
1=enable increase/decrease

0=price can't be changed
1=price can be changed by # key
Press  to enter or change other PLU.

Press the  key twice to return to the weighing mode.

Note:Each option can be selected or hided through "code 66666".

Price change

    Call the menu "PRICE CHANGE"

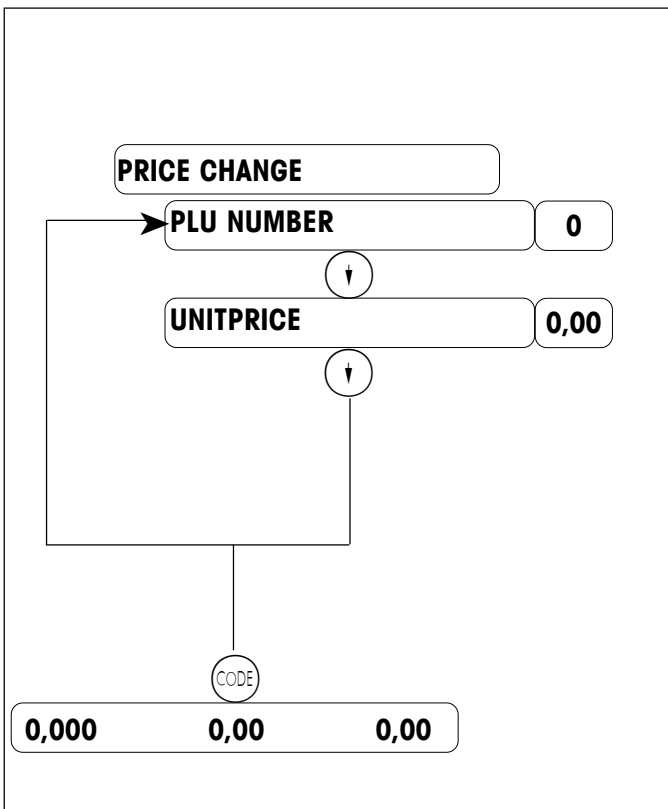

Enter price change





Enter PLU number.(up to 6 digits)

Enter the unitprice.

Press  for other price changes.

Press  to return to weighing mode.

Define presets

    Call the menu "DATA ENTRY"

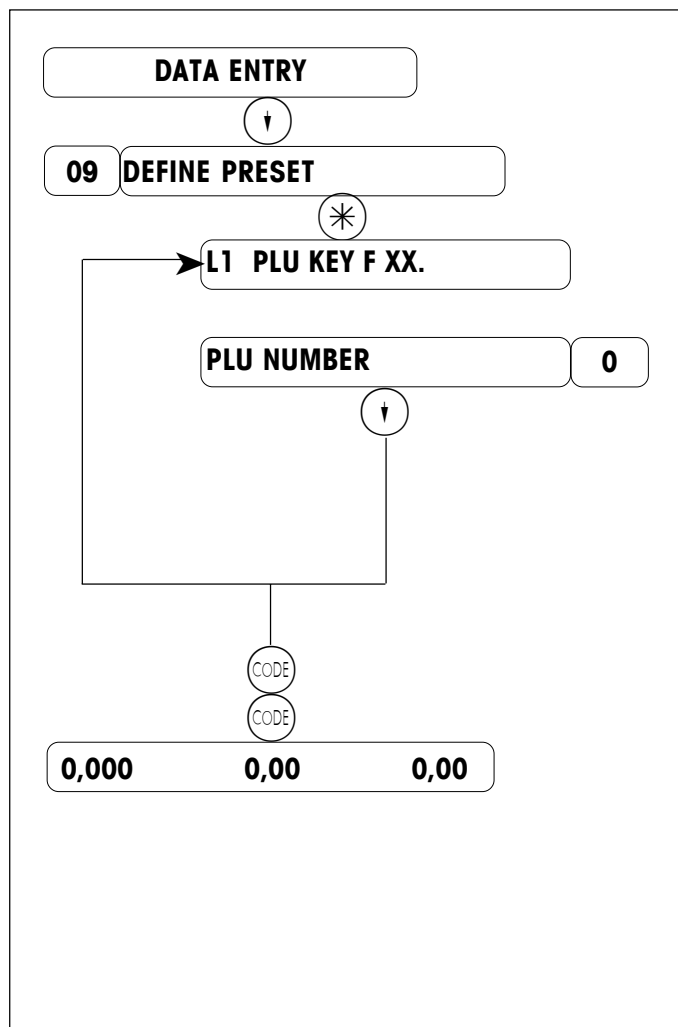

enter preset code 09.

*Press the desired PLU preset key
(Shift L1 and L2 by the key )

Enter PLU number.(up to 6 digits)

Press  to enter or modify another
PLU preset.

Press  2 times to return to weighing
mode.

Remark :

*Type 8442-XX00 scale can store 56 preset keys which are divided into two levels L1 and L2. L1 can store P1~P28 and L2 can store P29~P56. Type 8442-XX10 or 8442-XX10H can store 157 preset keys which are divided into two levels L1 and L2. L1 can store P1~P77 and L2 can store P78~P154.

Shift L1 and L2 by the key .

Tare entry

    Call the "DATA ENTRY" menu

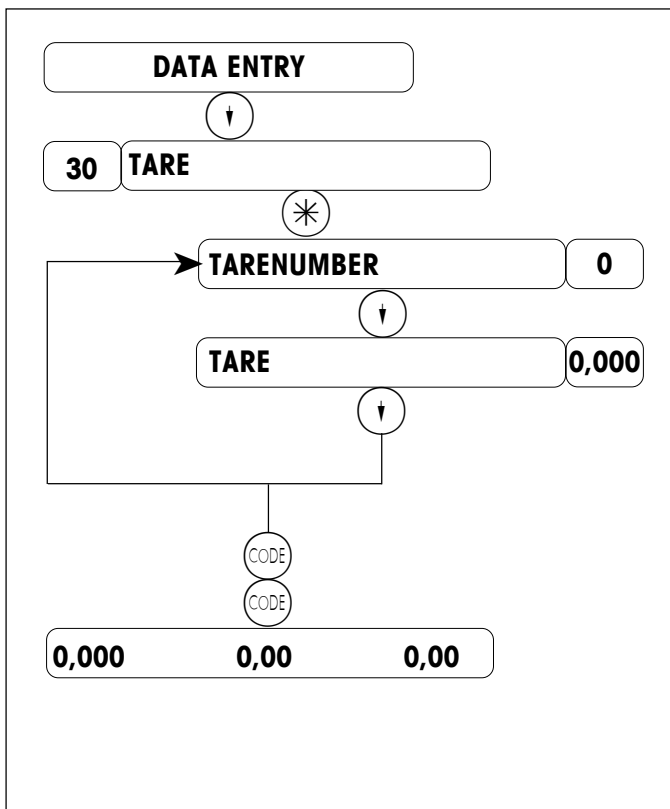

Enter the preset code 30

Enter the tare number (1-16).





Enter the tare weight in grams *) or put the empty recipient on the scale, then validate with the tare key .

Press  to affect the next tare memory.

Press the  key twice to return to the weighing mode.

*) Respect the increment (1 g, 2 g or 5 g, depending on the weighing range)

Create EAN code

    Call the "DATA ENTRY" menu

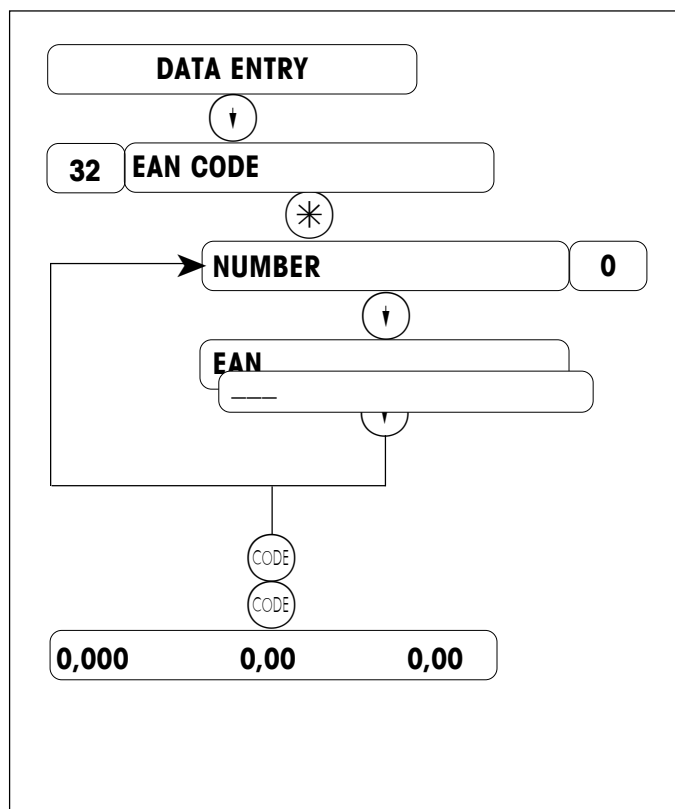

Enter the preset code 32

Enter the EAN number (1-8).

Enter the EAN CODE such as 22AAAAAABBBBB etc.

Press  to affect the next EAN code memory.

Press the  key twice to return to the weighing mode.

Legend of Barcode Identifications

A = Item number	4 - 12 figures
B = Total Price	4/5/6 figures
C = Check digit	1 figures
D = Date	2/4/6 figures
N = Ticket number	4 figures
P = PLU code	4/5/6 figures
Q = Weight/Quantity	4/5 figures
W = Group number	2 figures
0-9 Figures	1 - 12 figures

Examples:

OAAAAAAAAA (UPC, Ten digit Item Number)

2AAAAACBBBB (UPC, 5-D Item/Price Check Digit/4-D Price)
 2AAAAA0BBBB (UPC, 5-D Item/Zero Fixed/4-D Price)
 2AAAAAABBBB (UPC, 6-D Item/No Price Check/4-D Price)
 2AAAAABBBBB (UPC, 5-D Item/No Price Check/5-D Price)
 2AAAAACQQQQ (UPC, 5-D Item/Wgt Check Digit/4-D Wgt)
 2AAAAA0QQQQ (UPC, 5-D Item/Zero Fixed/4-D Wgt)
 2AAAAAQQQQ (UPC, 6-D Item/No Price Check/4-D Wgt)
 2AAAAQQQQQ (UPC, 5-D Item/No Price Check/5-D Wgt)
 21AAAAAABBBB (EAN, 6-D Item/4-D Price)
 21AAAAABBBB (EAN, 5-D Item/5-D Price)
 21AAAABBBBB (EAN, 4-D Item/6-D Price)
 21AAAAACBBBB (EAN, 5-D Item/Price Check Digit/4-D Price)
 21AAAAACBBBB (EAN, 4-D Item/Price Check Digit/5-D Price)
 21AAAAQQQQQ (EAN, 5-D Item/5-D Wgt)
 21AAAAACQQQQ (EAN, 4-D Item/Wgt Check Digit/5-D Wgt)

Vendor preset key configuration

- Vendor name edit

 **CODE** 1 * Call the "DATA ENTRY" menu

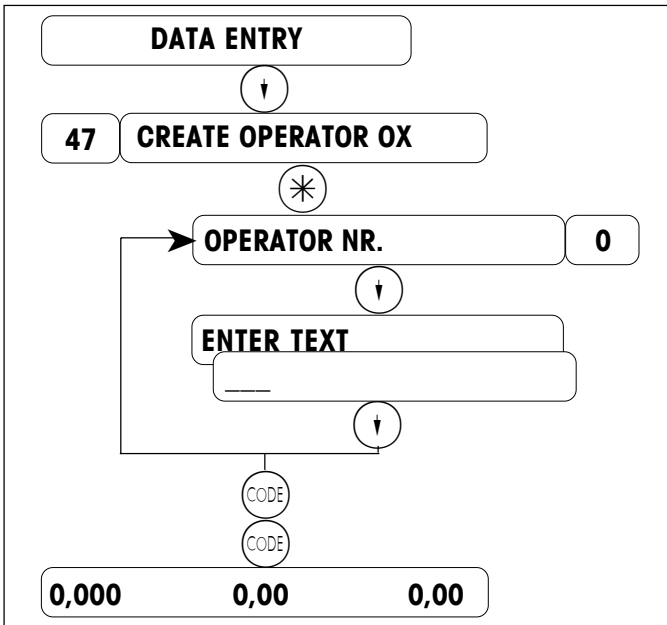

Enter preset code 47.

Enter the number of the desired vendor.

Enter the name of the vendor.

Press  to enter or modify another vendor's number.

Press the  key twice to return to the weighing mode.

- Vendor preset key permission

 **CODE** 4 4 5 5 6 6 * Call the "KEYBOARD CONFIGURATION" menu

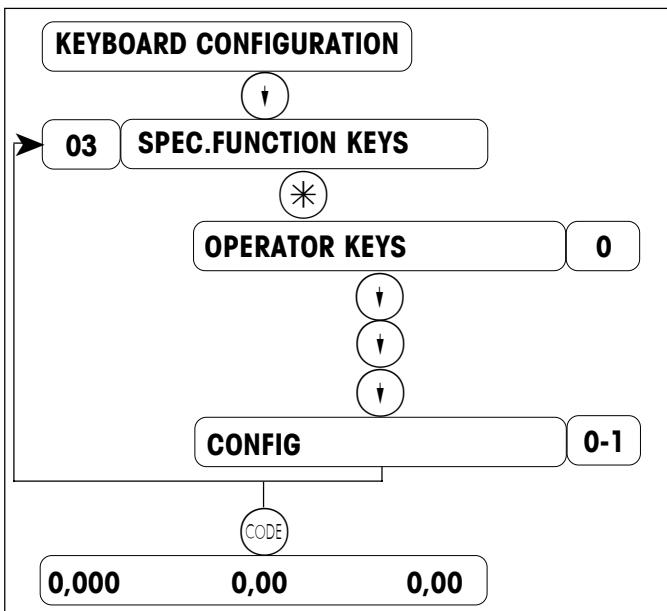

Enter preset code 03.

Enter number of operator keys.(1~4)

0=Don't storage the configuration.
1=Storage the configuration.

Press the  key to return to the weighing mode.

- Log in and log out an operator

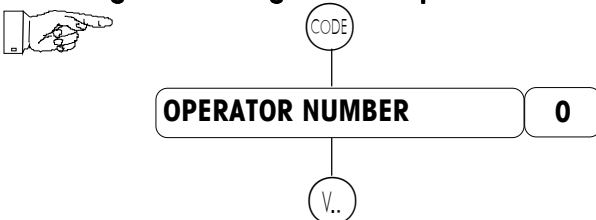





Enter the number of the desired vendor.

Then press one vendor key to assign this key to this vendor.If the key had been assigned before this operation,previous assignment will be cancelled.



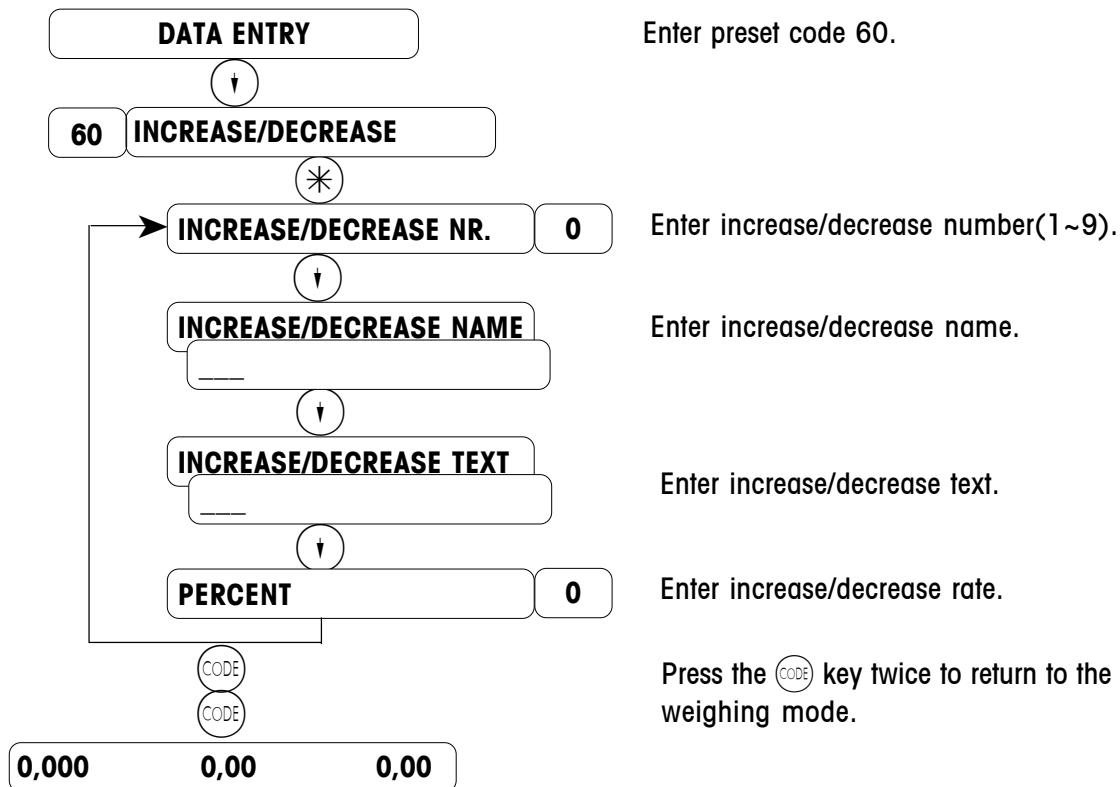

Increase/decrease key configuration

• Increase/decrease rate edit

    Call the "DATA ENTRY" menu



• Increase/decrease permission

     Call the "INCREASE/DECREASE" menu

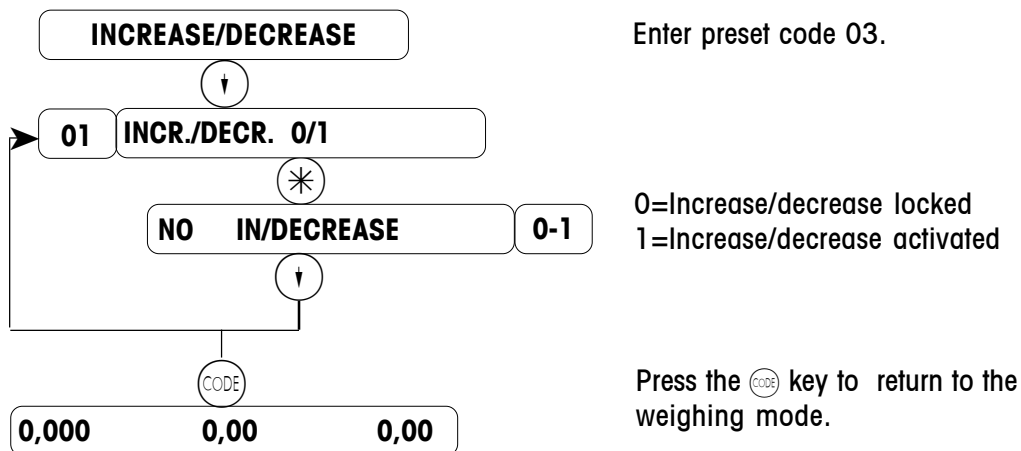

• **Log in increase/decrease key**

 **CODE** 4 4 5 5 6 6 * Call the "KEYBOARD CONFIGURATION" menu

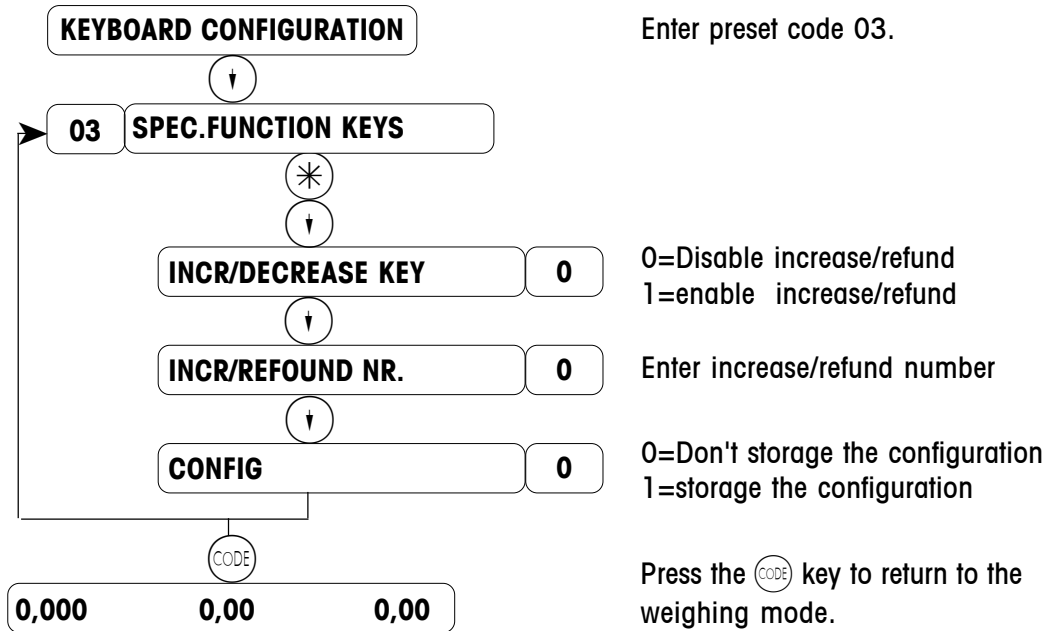

Instructions for special offers

• **Define a special offer**

 **CODE** 1 * Call the "DATA ENTRY" menu

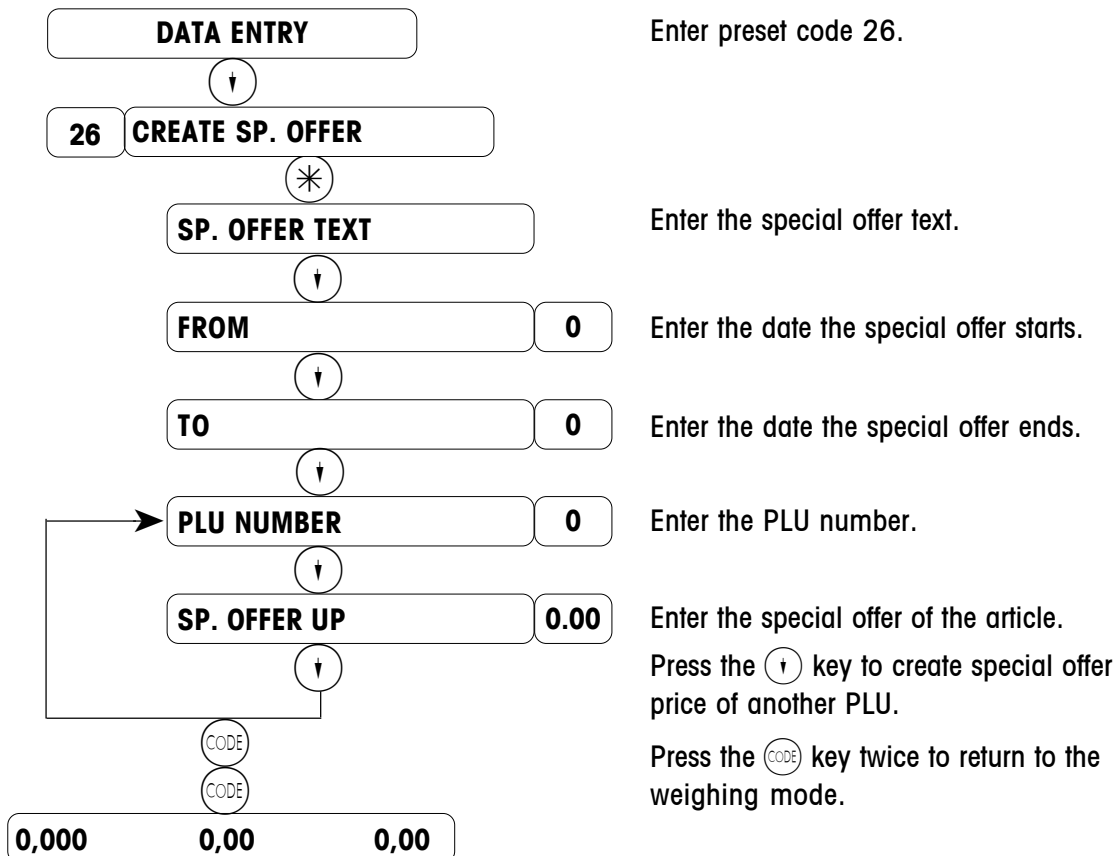

• **Cancel a special offer**

 **CODE** 1 * Call the "DATA ENTRY" menu

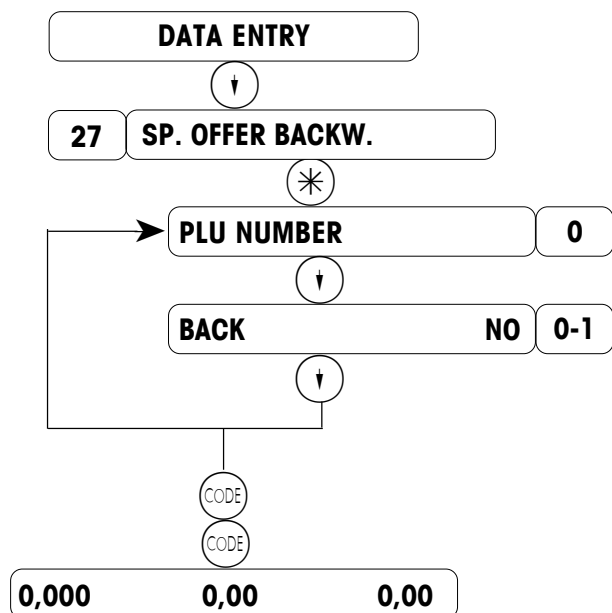

Enter preset code 27.

Enter the PLU number.

0=No prohibition
1=Prohibit SP. OFFER for this PLU

Press the  key to prohibit special offer price of another PLU.

Press the **CODE** key twice to return to the weighing mode.

Choose the print paper(ticket or label)

 **CODE** 4 4 4 4 * Call the "OPERATOR CONFIG" menu

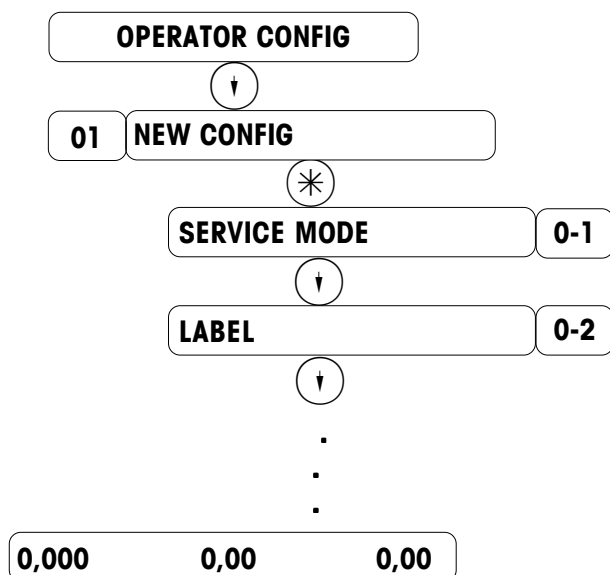

Enter preset code 01.

Select the status of service mode or prepack mode when open the scale
0=service mode; 1=prepack mode

0=cust. ticket; 1=label; 2=label+total label



Press the  key until return to the weighing mode.

Sales mode

Mode switching

 **MODE** Call the menu "Mode switching"

MODE CHANGE		↓
00	SERVICE	↓
01	VOID OPER.	↓
02	PREPACK	↓
03	CODE-MODE	↓
04	TRAINING-MODE	↓
08	LARGE SALES	↓
09	MENU END	↓

With   select the desired sub-menu, or enter the preset code.

Select/return to service mode.



Select/return to void operation mode.

Select/return to prepack mode.

Select/return to code mode.

Select/return to training mode.

Select/return to large sales mode.

Press  to continue or  to return to weighing mode.

With   or the preset code, select the corresponding menu item, then activate it with the  key.

Service mode

-For all weighing functions, registering, data entry and sales reporting

Code mode

-Enter the code functions

Training mode

-Learning and practical exercises on the device, without the realized turnover being memorized.

-The display reads "TRAINING"

Void oper. mode

-VOID OPERATION AFTER CHECK OUT means the ticket or label has been printout, and these transactions will be deleted from the statistics data.

Prepack mode

-For packing fieldwork of the supermarket. In this application, only print label, the small variety but large quantity print-work.

Large sales mode

-When the article is too big to weigh, operator can enter this mode by inputting the article weight and count price.

Register (with printing on customer ticket)

1. Weighed PLU/ PLU per piece / overwriting of a defined price per piece

- Put the article on the scale.
- Press a direct PLU preset key or enter the PLU code.
(Overwriting of a defined price per piece :
The defined price per piece can eventually be overwritten by the current article, by pressing (#)).
or press (#) key first to enter a weighed price for an article per piece, first press (+) or (-) to entry the temporary price.
- Register the transaction with your personal (V..) key.
- Register the next article.
- Conclude the sale and print off the customer ticket by pressing the (*) key, followed by your personal (V..) key.

2. Subtotal

Displaying the subtotals of all the vendors

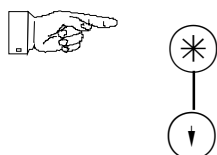

By repeatedly pressing the (↓) key, check the subtotal of every vendor.

Displaying the subtotal of vendor x

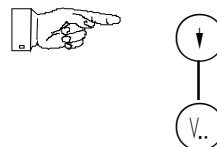

3. Calculating the change

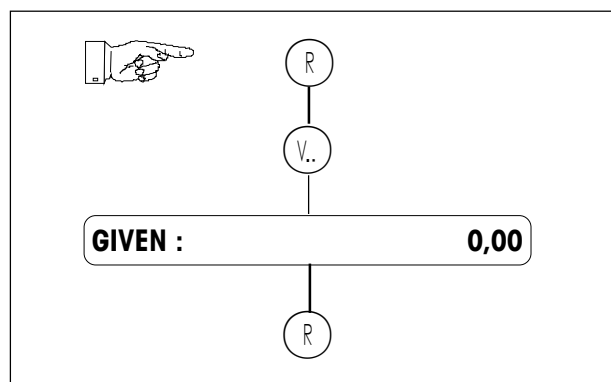

To use the "Calculating the change function", you only have to conclude the sale by the following sequence of keystrokes, the key [R] replaces the key (*)

Enter the amount received by the client.

The cashregister opens automatically.

Void

a) The last operation



b) one of the previous operations



Remarks : With you have an overview of the different transactions printed on the ticket.

Register (with printing on label)

1. Weighed PLU/ PLU per piece / overwriting of a defined price per piece

- Put the article on the scale.
- Press a direct PLU preset key or enter the PLU code.
(Overwriting of a defined price per piece :
The defined price per piece can eventually be overwritten by the current article, by pressing).
or press key first to enter a weighed price. for an article per piece, first press or to entry the temporary price.
- With your personal key , start printing the label.

Tare



a) Compensation of a weighed tare (tare an empty recipient)

- Place the empty recipient.
- Press the  key.
- Put the full recipient and register the transaction.
- The tare weight is cleared from the moment the transaction is registered and the scale is cleared.

b) Plu specific tare weight

the tare is linked with plu, recall the plu to recall it.



c) Fixed tare compensation

- Put tare weight on the scale.
- Press the  key.
- Press the  key.

d) Recall an operator specific tare weight



The tare has to be logged in before recall. The way to log in is as follow:

- Place the empty recipient.
- Press the  key.
- Press the  key.

Turn on and off the backlight of display



Turn on the backlight.



Turn off the backlight.

Prepacking

Select the prepacking mode

 **MODE** Call the menu "Mode switching"

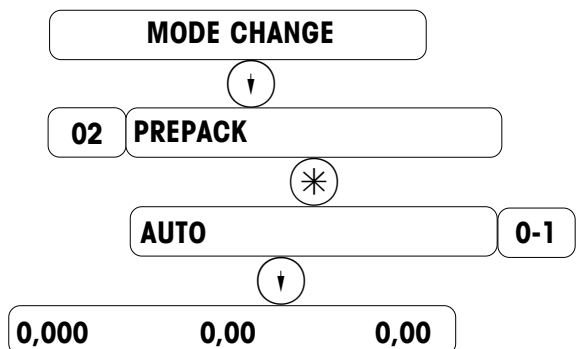

Enter preset code 02.

Select/return to prepack mode

Select the print triggering mode:
0=print after stabilizing; 1=print by pressing the vendor key.

Procedure

- Select the PLU
- Place the article
- Using the vendor key, start label printing (if "manu" is chosen) or start label printing by varying the load (if "auto" is chosen).
- Remove the label
- Weight the next article

Print a batch of prepack labels for the article by Count PLU

This function can be in prepack mode only, it is in effect under auto-print status. And only for the articles by Count PLU.

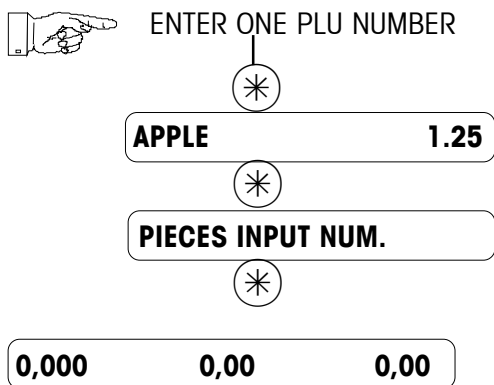

Before you call a plu, you must empty the platter of scale.

Active batch print function

Display the price of the PLU, you can enter number follow X key for more than one.

Enter print quantity (max. 999 pcs)

After the previous label is taken away, then print the next label.

NOTE: Press the key **MODE** twice can quickly switch prepack mode and service mode.

Large sales mode



Call the menu "Mode switching"

MODE CHANGE

Enter preset code 08.



08

LARGE SALES



enter large sales mode

0,000

0,00

0,00

After entering large sales mode, operator shall first input the called PLU ,if the parameter of "price shall be entered via key (#) has been configured " . Then press the key (#) , enter large sales weight and register this transaction. If the price is required to input temporarily, operator shall first press the key (#), then enter the temporal price , again press the key (#) , input large sales weight and register this transaction at last.

Maintenance

Replacing the thermal paper roll

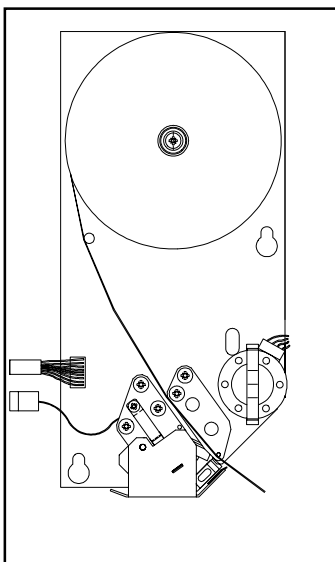

- Open the door of printer housing on the right side of the scale, pull out printer.
- Remove the empty reel.
- Press down the green lever.
The print head (A) flips out of his housing.
- Insert the new thermal paper roll in accordance with the drawing.
- The extremity of the paper being on the left side of the roll.
- Pull out the paper until correct tension is reached.
- Push back the print head until it clicks.
- Tear off the paper that sticks out.
- Close the weighing plate.

Cleaning the print head

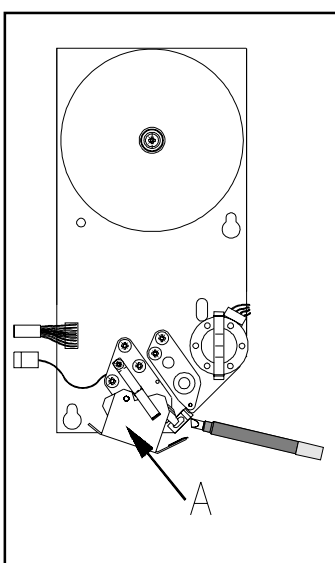

- Switch off the scale.
- open the door of printer holder on the right side of the scale.
- pull out the printer.
- Press down the green lever.
The print head (A) flips out of his housing.
- Take off the cap from the cleaning pen.
- Clean the print head with the moist tip of the pen.
- Push back the print head until it clicks.
- Put on the cap of the cleaning pen.
- Pull back the printer, close the door.
- Switch on the scale.



Use only the cleaning pen, for cleaning the print head. The cleaning pen be enclosed with the scale. Other cleaning materials will destroy the print head.

Appendix A: Network Configuration

Call the menu "Technical service "

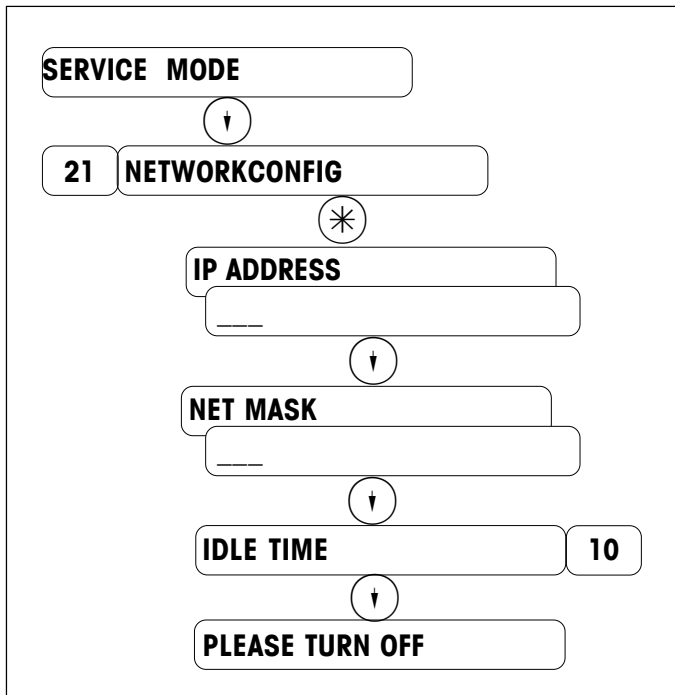

Enter the preset code 21.

Enter network configure

Input IP address

Input NET MASK address

Input IDLE TIME

Turn off power and power up again, complete setup.

After completing setup, please check IP address, if necessary. (whether address is duplicate?). The operation as follows:

Call the menu "Technical service "

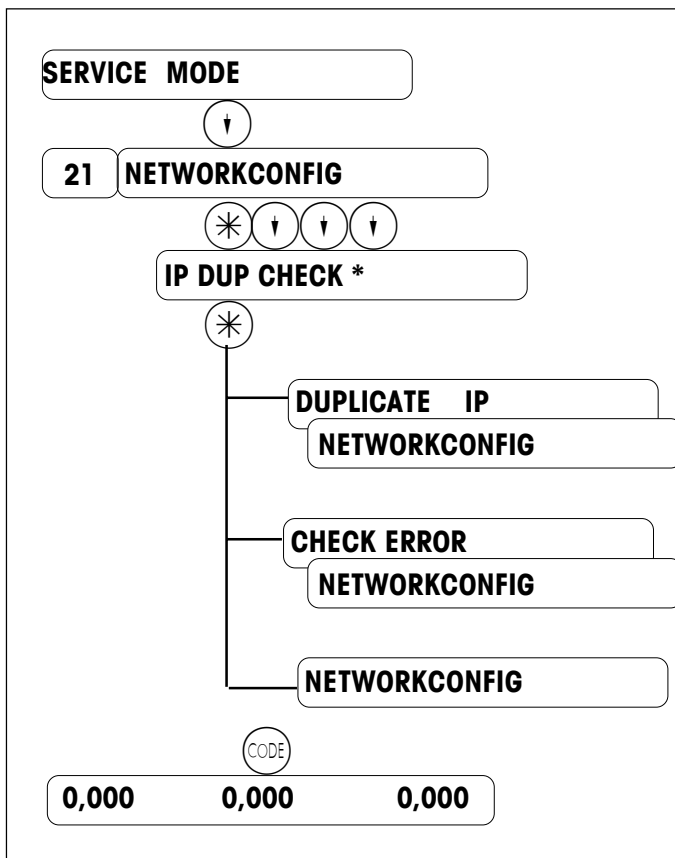

Enter the preset code 21.

Enter IP DUPCHECK sub-menu

If IP duplicate, then show this message, reset IP address.

If at that time can not check whether IP is duplicate or not, this message will show. (maybe the scale is in process of communication or network card is wrong. If not found IP address duplication, will show as left display.

Press to exit.

For Type 8442-X6XX and 8442-X6XXH

 **CODE** 2 4 6 8 1 3 5 7 * Call the menu "Technical service "

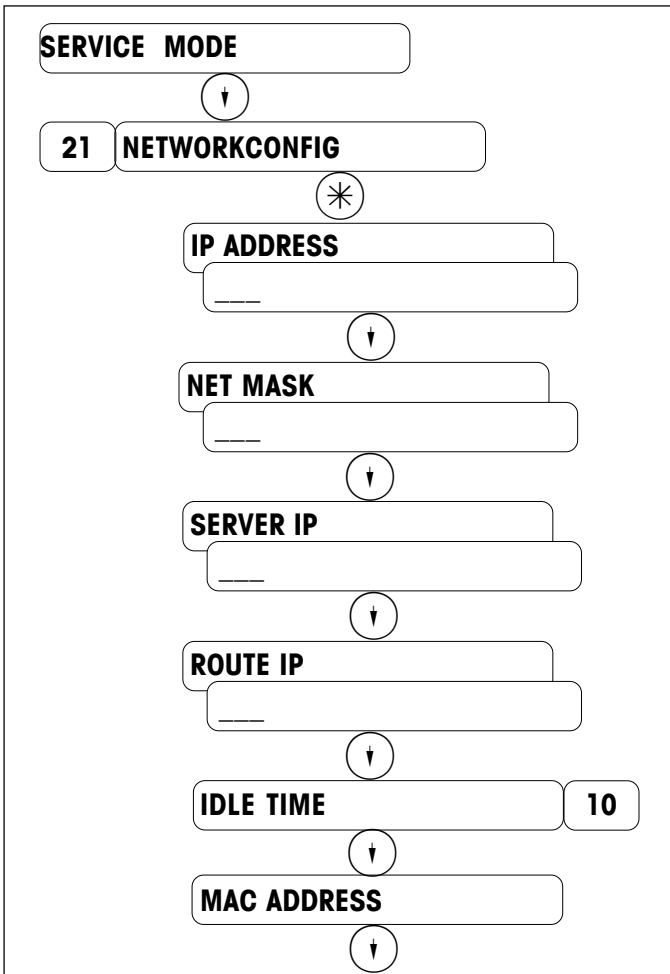

Enter the preset code 21.

Enter network configure

Input IP address

Input NET MASK address

Input SERVER IP address (If necessary)

Input ROUTE IP address (If necessary)

Input IDLE TIME (10 is ok)

Scale will restart automatically.

After completing setup, if necessary you can choose the PLU SOURCE and PLU RANGE. The operation as bellow:

 **CODE** 2 4 6 8 1 3 5 7 * Call the menu "Technical service "

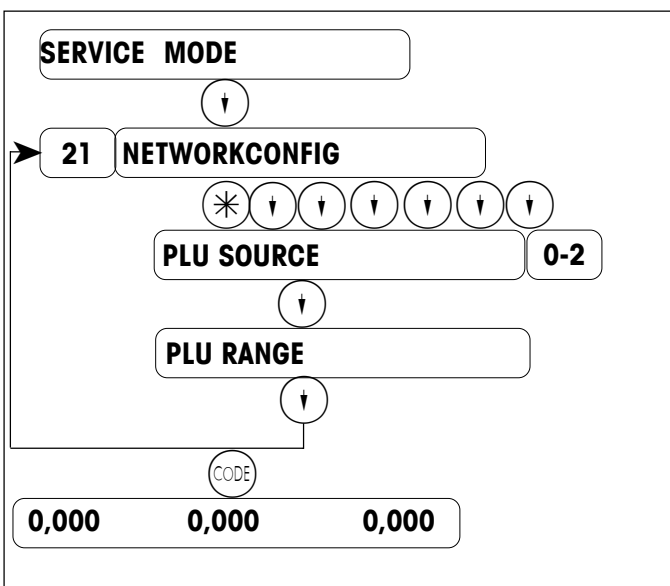

Enter the preset code 21.

0=Get PLU from local scale
 1=Get PLU from NETWORK
 2=First from network, then from local scale

0=Means all kinds of PLU number.
 Else number define the digits of PLU in this scale

Press **CODE** to exit .

Appendix B:

Error Message

- **Warning Message**

INPUT TOO BIG

The input is too big.

INPUT TOO SMALL

The input is too small.

TOO MUCH INPUT

The input is out of limit.

WRONG CODENR.

The code number is invalid.

KEY NO FUNCTION

The key has no function.

KEY BLOCKED

The key is disabled. Check the KEYBOARD CONFIGURE.

PLU NOT FOUND

The entered PLU number does not exist.

AG NOT FOUND

The entered Group number does not exist.

OPER.NOT FOUND

The entered Operator number does not exist.

LABEL NOT FOUND

The entered Label Format does not exist.

PLUNR IS OCCUP

You are trying to duplicate a PLU into an exist PLU number.

LABELNR. OCCUP

You are trying to duplicate a label format into an exist label format number.

DISCOUNT IMPOSS

This PLU does not allow to be discounted. Check the PLU Discount configuration, or this PLU is in special offer.

NO FURTHER REG.

No further transaction has been recorded.

NO STABLE WEIGHT

The weight is not stable.

AG NOT DELETABLE

This Group contains total data and can not be deleted.

OP NOT DELETABLE

This Operator contains total data and can not be deleted.

MEMORY FULL

Memory is full.

WEIGH AGAIN

You are trying to record one item twice. Remove the item from the platter and put a new item on the platter.

WRONG LABEL

The installed label roll does not match the configured label format.

LABEL MOVED

The stepper motor or the rewind motor is not working properly.

CHANGE PAPERROLL

The label roll is not installed or the label roll is empty.

TAKE LABEL OFF

Take off the current label before printing the next one.

NO FREE OX KEY

All the configured operator keys have been occupied.

PRINT TICKET

Print out the customer ticket before logging out.

OPEN CUST. TICK

You are trying to delete an operator who has total data.

OX NOT LOGGED-IN

The operator has not be assigned to an operator.

PAYMENT TOO LOW

The payment is less than the total amount.

TARE TOO BIG

The entered tare is too big.

PLU TARE ACTIVE

You are forbidden to override the PLU tare.

PUT PLATTER ON

The weight is too small and out of power up zero range.

ZERO NOT CAPTURE

The weight is too big and out of power up zero range.

WEIGHT TOO SMALL

The weight is too small to be printed.

ERROR TAKE-SENS

The take label sensor is not working properly.

ERROR POS_SENS

The gap sensor is not working properly.

ERROR INTERFACE

The serial port is not working properly.

• Error Message

Listed below are the possible error codes are listed. When an error code appears, the scale should be switched off and on. In many cases the error will disappear.

There are 3 different kinds of error messages:

Error Status 1:

Warning! After the warning the scale can still be used.

Error Status 2:

Press "CODE" key. Change to one of the CODE menu. Back to normal operation mode.

Error Status 3:

Press "CODE" key and enter SERVICE MODE, after returning to normal operation mode the scale will perform RESET.

Error Message	Reason	Status	Action
ERROR 300 PRINTER	Printer driver defect	2	Replace Main Logic PCB
ERROR 301 PRINTER	Printer driver defect	2	1 Reflash the software 2 Replace Main Logic PCB
ERROR 307 PRINTER	Printhead defect	2	1 Replace printhead 2 Replace printhead harness 3 Replace Main Logic PCB
ERROR 308 PRINTER	Printer driver defect	1	Replace Main Logic PCB
ERROR 310 PRINTER	Printer driver defect	2	Replace Main Logic PCB
ERROR 101 AP	Real Time Clock defect	1	Replace Main Logic PCB
ERROR 400 CELL	Load Cell defect	-	1 Replace Main Logic PCB 2 Replace Load Cell
ERROR 401 CELL	Load Cell defect	-	1 Recalibrate 2 Replace Main Logic PCB 3 Replace Load Cell
ERROR 200 DATABASE	Data bank error	3	Reset RAM
ERROR 201 XX DATABASE	XX Data error	2	1 Reset RAM 2 Delete Data XX
ERROR 202 XX DATABASE	XX Data error	2	1 Reset RAM 2 Delete Data XX
ERROR 203 YY DATABASE	YY Data error	2	1 Reset RAM 2 Configure YY
ERROR 205 DATABASE	Data bank error	3	Reset RAM

Meaning of XX

01 Operator	07 Group data
02 Ticket data	13 Label data
03 Time total data	15 Date text data
04 Text data	21 PLU label data
05 Barcode data	23 Store adress
06 Tare data	24 PLU data

Meaning of YY

01 Operator Configure	04 Password Configure
03 Keyboard Configure	

Appendix C: Fonts Table

Font No.	Font Type	Heigh in mm	Characters per line
1	AaBbCcDdEeFfGgHhIiJjKkLlMmNnOoPp	1.9	36
2	AaBbCcDdEeFfGgHhIiJjKkLlMmNnOoPp	2.4	36
3	AaBbCcDdEeFfGgHhIiJjKkLlMmNnOoPp	2.9	36
4	AaBbCcDdEeFfGgHhIiJjKkLlMmNnOoPp	3.7	36
5	AaBbCcDdEeFfGgHhIiJjKkLlMmNnOoPp	4.8	36
6	AaBbCcDdEeFfGgHhIiJjKkLl	3.2	27
7	AaBbCcDdEeFfGgHhIiJjKkLl	6.4	27
8	AaBbCcDdEeFfGgHh	2.4	18
9	AaBbCcDdEeFfGgHh	2.9	18
10	AaBbCcDdEeFfGgHh	3.7	18
11	AaBbCcDdEeFfGgHh	4.8	18
12	AaBbCcDdEeFfGgHh	4.8	18
13	AaBbCcDdEeFfGgHh	9.6	18
14	AaBbCcDdEeFf	3.2	13
15	AaBbCcDdEeFf	6.4	13
16	AaBbCcDdEe	2.9	11
17	AaBbCcDdEe	3.7	11
18	AaBbCcDdEe	4.8	11
19	AaBbCcDd	4.8	9
20	AaBbCcDd	9.6	9

METTLER TOLEDO
Scales & Systems

1900 Polaris Parkway
Columbus, Ohio 43240

P/N: 139751

(9/02).01

METTLER TOLEDO®
is registered trademarks of Mettler-Toledo, Inc.
©2000 Mettler-Toledo, Inc.

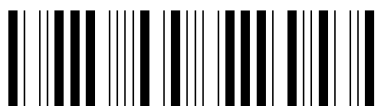

139751