



IP Office

IP Office Installation

Notice

While reasonable efforts were made to ensure that the information in this document was complete and accurate at the time of printing, Avaya Inc. can assume no liability for any errors. Changes and corrections to the information in this document may be incorporated in future releases.

Documentation Disclaimer

Avaya Inc. is not responsible for any modifications, additions, or deletions to the original published version of this documentation unless such modifications, additions, or deletions were performed by Avaya.

Link Disclaimer

Avaya Inc. is not responsible for the contents or reliability of any linked Web sites referenced elsewhere within this Documentation, and Avaya does not necessarily endorse the products, services, or information described or offered within them. We cannot guarantee that these links will work all of the time and we have no control over the availability of the linked pages.

License

USE OR INSTALLATION OF THE PRODUCT INDICATES THE END USER'S ACCEPTANCE OF THE TERMS SET FORTH HEREIN AND THE GENERAL LICENSE TERMS AVAILABLE ON THE AVAYA WEBSITE AT <http://support.avaya.com/LicenseInfo/> ("GENERAL LICENSE TERMS"). IF YOU DO NOT WISH TO BE BOUND BY THESE TERMS, YOU MUST RETURN THE PRODUCT(S) TO THE POINT OF PURCHASE WITHIN TEN (10) DAYS OF DELIVERY FOR A REFUND OR CREDIT.

Avaya grants End User a license within the scope of the license types described below. The applicable number of licenses and units of capacity for which the license is granted will be one (1), unless a different number of licenses or units of capacity is specified in the Documentation or other materials available to End User. "Designated Processor" means a single stand-alone computing device. "Server" means a Designated Processor that hosts a software application to be accessed by multiple users. "Software" means the computer programs in object code, originally licensed by Avaya and ultimately utilized by End User, whether as stand-alone Products or pre-installed on Hardware. "Hardware" means the standard hardware Products, originally sold by Avaya and ultimately utilized by End User.

License Type(s): Designated System(s) License (DS).

End User may install and use each copy of the Software on only one Designated Processor, unless a different number of Designated Processors is indicated in the Documentation or other materials available to End User. Avaya may require the Designated Processor(s) to be identified by type, serial number, feature key, location or other specific designation, or to be provided by End User to Avaya through electronic means established by Avaya specifically for this purpose.

Copyright

Except where expressly stated otherwise, the Product is protected by copyright and other laws respecting proprietary rights. Unauthorized reproduction, transfer, and or use can be a criminal, as well as a civil, offense under the applicable law.

Third-Party Components

Certain software programs or portions thereof included in the Product may contain software distributed under third party agreements ("Third Party Components"), which may contain terms that expand or limit rights to use certain portions of the Product ("Third Party Terms"). Information identifying Third Party Components and the Third Party Terms that apply to them is available on Avaya's web site at: <http://support.avaya.com/ThirdPartyLicense/>

Avaya Fraud Intervention

If you suspect that you are being victimized by toll fraud and you need technical assistance or support, call Technical Service Center Toll Fraud Intervention Hotline at +1-800-643-2353 for the United States and Canada. Suspected security vulnerabilities with Avaya Products should be reported to Avaya by sending mail to: securityalerts@avaya.com. For additional support telephone numbers, see the Avaya Support web site (<http://www.avaya.com/support>).

Trademarks

Avaya and the Avaya logo are registered trademarks of Avaya Inc. in the United States of America and other jurisdictions. Unless otherwise provided in this document, marks identified by "®," "™" and "SM" are registered marks, trademarks and service marks, respectively, of Avaya Inc. All other trademarks are the property of their respective owners.

Documentation information

For the most current versions of documentation, go to the Avaya Support web site (<http://www.avaya.com/support>) or the IP Office Knowledge Base (<http://marketingtools.avaya.com/knowledgebase/>).

Avaya Support

Avaya provides a telephone number for you to use to report problems or to ask questions about your contact center. The support telephone number is 1 800 628 2888 in the United States. For additional support telephone numbers, see the Avaya Web site: <http://www.avaya.com/support>.

Contents

1. Installing IP Office

1.1 Equipment Availability.....	10
1.2 RoHS	10
1.3 Repair	10

2. System Overview

2.1 Small Office Edition System Components.....	13
2.2 IP400 Office System Components.....	14
2.3 IP500 Office System Components.....	16
2.4 Control Units.....	18
2.5 Control Unit Summary.....	19
2.6 IP Office Standard Edition.....	20
2.7 IP500 Base Cards.....	21
2.8 IP500 Trunk Cards.....	23
2.9 IP400 Trunk Cards.....	24
2.10 External Expansion Modules.....	26
2.11 Other Cards.....	31
2.12 Power Supplies.....	33
2.13 Power Supply Cords.....	34
2.14 Power Supply Backup.....	35
2.15 Cabling and Cables.....	36
2.16 Grounding.....	38
2.17 Lightning Protection/Out-of-Building Connections.....	39
2.18 Wall and Rack Mounting.....	40
2.19 Feature Key Dongles.....	42
2.20 License Keys.....	43
2.21 IP Office Phones.....	44
2.22 Core Software & BIN Files.....	45
2.23 Supported Country Locales.....	47
2.24 Programming Applications.....	49
2.25 User Applications.....	50
2.26 Voicemail Applications.....	51
2.27 Call Logging Applications.....	52
2.28 Call Center Applications.....	52
2.29 CTI Applications.....	53
2.30 Application CD's/DVD's.....	54
2.31 VoIP	55
2.32 Voice Compression Channels.....	56
2.33 Training	57
2.34 Web Sites.....	58

3. Planning

3.1 Space Requirements.....	62
3.2 Environmental Requirements.....	64
3.3 Tools and Parts Required.....	65

4. Pre-Configuration

4.1 Off Line Configuration.....	68
4.2 Creating a New Configuration.....	69
4.3 Importing and Exporting Settings.....	70

5. Small Office Edition Installation

5.1 Unpacking.....	74
5.2 Installing the Admin Applications.....	75
5.3 Default Control Unit Power Up.....	77
5.4 Connecting the Manager PC.....	79

5.5 Receiving a Configuration (Pre 3.2).....	80
5.6 Using Monitor.....	81
5.7 Fitting Trunk Cards (SOE).....	82
5.8 Shelf/Wall Mounting.....	84
5.9 Grounding (SOE).....	86
5.10 Upgrading the Core Software.....	87
5.11 Configuring Security Settings.....	89
5.12 Receiving a Configuration (3.2+).....	90
5.13 Running the System Status Application.....	91

6. IP400 Basic Installation

6.1 Unpacking.....	94
6.2 Installing the Admin Applications.....	95
6.3 Control Unit Power Up.....	97
6.4 Connecting the Manager PC.....	99
6.5 Receiving a Configuration (Pre 3.2).....	100
6.6 Using Monitor.....	101
6.7 Fitting VCM Cards.....	102
6.8 Fitting Modem Cards.....	104
6.9 Fitting Trunk Cards.....	106
6.10 Rack Mounting.....	109
6.11 Adding Expansion Modules.....	111
6.12 Adding a WAN3 Module.....	113
6.13 Grounding.....	115
6.14 Upgrading the Core Software.....	117
6.15 Configuring Security Settings.....	120
6.16 Receiving a Configuration (3.2+).....	121
6.17 Running System Status Application.....	122

7. IP500 Basic Installation

7.1 Tools Required.....	126
7.2 Read the Documentation.....	127
7.3 Unpacking.....	128
7.4 IP500 Card Installation.....	129
7.5 Inserting the Feature Key.....	133
7.6 Applying Power.....	134
7.7 Installing the Admin Applications.....	136
7.8 Connecting the Manager PC (IP500).....	138
7.9 Start Manager.....	139
7.10 Upgrading the Core Software.....	140
7.11 Check the CPU LED.....	141
7.12 Check the Card LEDs.....	142
7.13 Receiving the Configuration.....	143
7.14 Adding Licences.....	144
7.15 Adding External Expansion Modules.....	145
7.16 Configuring Security Settings.....	147
7.17 Rack Mounting.....	148
7.18 Wall Mounting.....	151
7.19 Grounding.....	153
7.20 Running System Status Application.....	155

8. Phone Installation

8.1 Installing 2400/5400 Series Phones.....	159
8.2 Installing an EU24 Add-On.....	164
8.3 BM32 Firmware Upgrade.....	165
8.4 Basic Button Programming.....	166
8.5 Changing Extension Numbers.....	168
8.6 Swapping Extension Users.....	170

9. External Trunk Configuration	
9.1 Clock Quality.....	174
9.2 Unused Trunks.....	176
9.3 Prefix Dialing.....	178
10. Additional Processes	
10.1 Upgrading the Core Software.....	182
10.2 Creating a WAN Link.....	184
10.3 IP500 Reset Button.....	185
10.4 Out of Building Telephone Installations.....	186
10.4.1 DS Phones.....	187
10.4.2 Analog Phone Barrier Box.....	188
10.4.3 Rack Mounting Barrier Boxes.....	190
10.5 Using the External Output Port.....	191
10.5.1 Port Connection.....	191
10.6 Licensing.....	192
10.6.1 License Keys.....	192
10.6.2 Feature Key Dongles.....	193
10.6.3 Installation Requirements.....	194
10.6.4 Serial Port Feature Key Installation.....	195
10.6.5 Parallel / USB Port Feature Key Installation.....	196
10.7 So8 BRI Module.....	197
10.7.1 Example 1: ISDN Terminal.....	197
10.7.2 Example 2: Video Conference.....	198
10.8 SNMP.....	200
10.8.1 SNMP Introduction.....	200
10.8.2 Installing the IP Office MIB Files.....	201
10.8.3 Enabling SNMP and Polling Support.....	203
10.8.4 Enabling SNMP Trap Sending.....	203
10.8.5 Trap Generation.....	204
10.9 DTE Port Maintenance.....	206
10.9.1 DTE Port Overview.....	206
10.9.2 DTE Port Settings.....	206
10.9.3 Erasing the Configuration.....	207
10.9.4 Defaulting Security Settings.....	209
10.9.5 Erasing the Operational Software.....	210
11. System Components	
11.1 Control Units.....	214
11.1.1 IP500.....	214
11.1.2 IP412.....	216
11.1.3 IP406 V2.....	218
11.1.4 IP406 V1.....	220
11.1.5 IP403.....	222
11.1.6 Small Office Edition (SOE).....	225
11.2 Internal Cards.....	227
11.2.1 Modem Cards.....	227
11.2.2 Wireless Card.....	227
11.2.3 Embedded Voicemail Memory Cards.....	228
11.2.4 Voice Compression Modules.....	229
11.3 IP400 Trunks Cards.....	230
11.3.1 Analog Trunk Card Uni (ATM4U).....	230
11.3.2 Analog Trunk Cards (ATM4).....	231
11.3.3 BRI Trunk Cards.....	231
11.3.4 T1 PRI Trunk Cards.....	232
11.3.5 E1 PRI Trunk Cards.....	232
11.3.6 WAN Trunk Card.....	233
11.3.7 E1R2 PRI Trunk Cards.....	233
11.4 IP500 Base Cards.....	234
11.4.1 Legacy Card Carrier.....	234
11.4.2 VCM.....	235
11.4.3 Digital Station.....	236
11.4.4 Analog Phone.....	237
11.5 IP500 Daughter Cards.....	238
11.5.1 Analog Trunk Card.....	238
11.5.2 BRI Trunk Cards.....	239
11.5.3 PRI Trunk Cards.....	240
11.6 IP400 Expansion Modules.....	241
11.6.1 Analog Trunk 16.....	241
11.6.2 Digital Station V2.....	243
11.6.3 Digital Station.....	245
11.6.4 Phone V2.....	247
11.6.5 Phone.....	249
11.6.6 So8.....	251
11.6.7 WAN3 10/100.....	253
11.7 IP500 Expansion Modules.....	255
11.7.1 Analog Trunk 16.....	255
11.7.2 BRI SO8.....	257
11.7.3 Digital Station.....	259
11.7.4 Phone.....	261
11.8 Phones.....	263
11.8.1 1603.....	264
11.8.2 1608.....	266
11.8.3 1616.....	268
11.8.4 2402.....	270
11.8.5 2410.....	271
11.8.6 2420.....	272
11.8.7 3616.....	273
11.8.8 3620.....	274
11.8.9 3626.....	275
11.8.10 3641.....	276
11.8.11 3645.....	277
11.8.12 3701.....	278
11.8.13 3711.....	279
11.8.14 3810.....	280
11.8.15 4406.....	281
11.8.16 4412.....	282
11.8.17 4424.....	283
11.8.18 4601.....	284
11.8.19 4602.....	285
11.8.20 4610.....	286
11.8.21 4620.....	287
11.8.22 4621.....	288
11.8.23 4625.....	289
11.8.24 5402.....	290
11.8.25 5410.....	291
11.8.26 5420.....	292
11.8.27 5601.....	293
11.8.28 5602.....	294
11.8.29 5610.....	295
11.8.30 5620.....	296
11.8.31 5621.....	297
11.8.32 6408D.....	298
11.8.33 6416D.....	299
11.8.34 6424D.....	300
11.8.35 T3 Classic.....	301

11.8.36 T3 Comfort.....	302	11.13.2 RoHS.....	386
11.8.37 T3 Compact.....	303		
11.9 Phone Add-Ons.....	304	12. Safety Statements	
11.9.1 4450.....	304	12.1 Safety and Homologation Statements.....	388
11.9.2 BM32.....	305	12.2 Lithium Batteries.....	389
11.9.3 EU24.....	306	12.3 Lightning Protection/Hazard Symbols.....	389
11.9.4 EU24BL.....	307	12.4 Trunk Interface Modules.....	390
11.9.5 T3 DSS.....	308	12.5 Further Information and Product Updates.....	391
11.9.6 201B RIM.....	309	12.6 Compliance with FCC Rules.....	391
11.9.7 XM24.....	310	12.7 Port Safety Classification.....	392
11.10 Applications.....	311	12.8 EMC Directive.....	393
11.10.1 Call Status.....	312	12.9 Regulatory Instructions for Use.....	394
11.10.2 Compact Business Center (CBC).....	313	12.9.1 Australia.....	394
11.10.3 Compact Contact Center (CCC).....	314	12.9.2 Canada.....	394
11.10.4 Conference Center.....	318	12.9.3 China.....	395
11.10.5 ContactStore.....	319	12.9.4 European Union.....	396
11.10.6 Delta Server.....	320	12.9.5 New Zealand.....	396
11.10.7 Feature Key Server.....	321	12.9.6 FCC Notification.....	396
11.10.8 Manager.....	322	Index	397
11.10.9 Monitor.....	323		
11.10.10 MS-CRM.....	324		
11.10.11 Phone Manager.....	325		
11.10.12 SoftConsole.....	327		
11.10.13 System Status Application (SSA).....	328		
11.10.14 TAPI.....	329		
11.10.15 VoiceMail Lite.....	331		
11.10.16 VoiceMail Pro.....	332		
11.10.17 IP Office Ports.....	336		
11.10.18 Operating System Summary.....	340		
11.11 Licence Keys.....	342		
11.11.1 IP500.....	343		
11.11.2 CCC.....	344		
11.11.3 CTI.....	345		
11.11.4 Phone Manager.....	346		
11.11.5 VoiceMail.....	347		
11.11.6 IP DECT.....	348		
11.11.7 Trial Licenses.....	349		
11.12 Ports	350		
11.12.1 Cables.....	351		
11.12.2 ANALOG Port.....	353		
11.12.3 AUDIO Port.....	353		
11.12.4 BRI Port (So).....	354		
11.12.5 BRI Port (To).....	355		
11.12.6 DC I/P Port.....	356		
11.12.7 DS Ports.....	356		
11.12.8 RS232 DTE Port.....	357		
11.12.9 EXPANSION Port.....	358		
11.12.10 EXT O/P Port.....	358		
11.12.11 LAN Port.....	359		
11.12.12 PF Port.....	360		
11.12.13 PHONE (POT) Port.....	361		
11.12.14 PRI Port.....	362		
11.12.15 WAN Port.....	363		
11.12.16 V.24 WAN Cable.....	364		
11.12.17 V.35 WAN Cable.....	365		
11.12.18 X.21 WAN Cable.....	366		
11.13 SAP Codes.....	367		
11.13.1 Availability.....	386		

Chapter 1.

Installing IP Office

1. Installing IP Office

This documentation is intended to assist with the installation of the core components of an Avaya IP Office telephone system. It describes those components and factors that should be considered for an installation.

- The IP Office is a converged voice and data communications system. It should therefore only be installed by persons with telephony and IP data network experience.
- Installers must be trained on IP Office systems. Through its Avaya University (AU), Avaya provides a range of training courses including specific IP Office implementation and installation training. It also provides certification schemes for installers to achieve various levels of IP Office accreditation. See Training.
- It is the installer's responsibility to ensure that all installation work is done in accordance with local and national regulations and requirements. It is also their responsibility to accurately establish the customer's requirements before installation and to ensure that the installation meets those requirements.
- You should read and understand this documentation before installation. You should also obtain and read the Avaya Technical Bulletins relevant to recent IP Office software and hardware releases to ensure that you are familiar with any changes to the IP Office equipment and software.

The following components of IP Office are outside the range of a basic IP Office installation. They are covered by separate installation and configuration documentation. If those components are to be part of the IP Office system installation, that documentation should be obtained, read and understood prior to the installation.

- **4600/5600 Series IP Phone Installation.**
- **Embedded Voicemail Installation.**
- **Voicemail Lite Installation.**
- **Voicemail Pro Installation.**
- **Delta Server (SMDR) Installation.**
- **Compact Business Center (CBC) Installation.**
- **Compact Contact Center (CCC) Installation.**
- **Contact Store Installation.**
- **Compact DECT Installation.**
- **IP DECT Installation.**
- **3600 Series Wireless IP Installation.**
- **Phone Manager Installation Manual.**
- **SoftConsole Installation Manual.**
- **Conference Center Installation Manual.**

1.1 Equipment Availability

SAP codes and details of specific items within this documentation are for reference only. Items available in any specific locale should be confirmed against the local Avaya IP Office price list for that locale. The local price list may also include additional items relative to the installation requirements of that locale.

1.2 RoHS

RoHS is an European Union directive for the Removal of Certain Hazardous Substances from Electrical and Electronic Equipment. Similar legislation has been or is being introduced in a number of other countries. Avaya has decided to make its global product range compliant with the requirements of RoHS. The actions taken vary

- In some cases equipment has been discontinued and is no longer available from Avaya.
- In some cases new manufactured stock has been made RoHS compliant and keeps its existing SAP code.
- In other cases the equipment has been replaced by a new RoHS compliant alternative with new SAP codes.

The SAP codes within this document are for RoHS compliant equipment unless otherwise stated.

1.3 Repair

IP Office systems do not contain any user serviceable or repairable components. If a faulty unit is suspected the whole unit should be replaced.

- IP400 control units should only be opened where indicated for the installation of IP400 cards.
- IP500 control units should not be opened under any circumstances.

Chapter 2.

System Overview

2. System Overview

This section looks at the components that collectively form IP Office systems. This includes aspects such as cabling and the need for additional non-Avaya IP Office equipment.

This section provides just a general description of individual units. For greater detail refer to the [System Components](#) section.

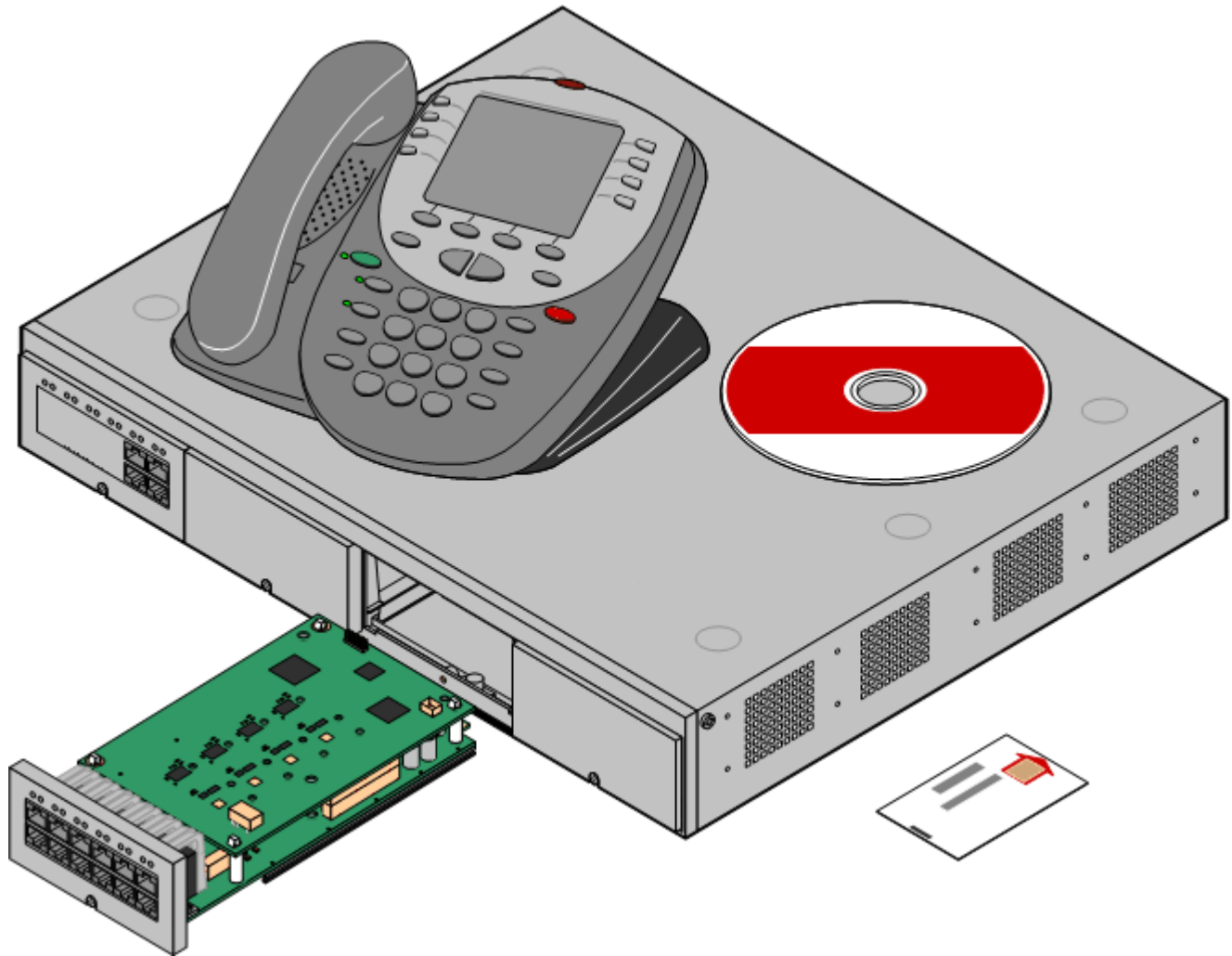

2.1 Small Office Edition System Components

The IP Office Small Office Edition is a single control unit with no external expansion modules. It is intended for small sites and branch offices.

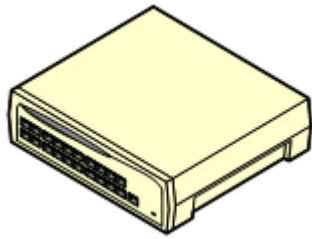

VK00nDd15SDvXoxkw9cR9x_jOXr_AWz9



- **IP Office Small Office Edition Control Unit**
The control unit holds the main configuration and performs the routing and switching for telephone calls and data traffic. Each Small Office control unit includes LAN ports, a Ethernet WAN port, and depending on the particular control unit variant a number of integral analog phone, analog extension and digital station ports.
- **Trunk Card**
The Small Office Edition control unit accepts a single IP400 trunk card for additional trunks.
- **Embedded Voicemail Memory Card**
IP Office embedded voicemail is supported by the addition of an Embedded Voicemail memory card.
- **Wireless Card**
The Small Office Edition can support an Avaya 802.11b WiFi wireless card.
- **Power Supplies**
Each Small Office Edition control unit is supplied with an external power supply unit. Additional power supply units may also be required for IP phones and some phone add-ons.
- **Power Cords**
Depending on the locale, different power cords are needed for the external power supply unit.
- **Cables**
The IP Office is designed primarily for connection to a structured cabling system using CAT3 UTP cabling. This approach allows telephone and data traffic to share the same wiring infrastructure and simplifies equipment moves.
- **Phones**
IP Office systems support a variety of Avaya digital and IP phones plus analog phones.
- **License Keys**
Various IP Office features and applications require a license key to be entered into the system's configuration. Each key is a 32-character text string unique to the feature being activated and the serial number of the Feature Key dongle (see below) installed in the system.
- **Feature Key Dongle**
A uniquely numbered dongle is used to validate license keys.
- **Application CD's/DVD's**
The IP Office applications can be ordered on a number of CD's. In addition they can be downloaded from the IP Office section of the Avaya support web site (<http://support.avaya.com>).

2.2 IP400 Office System Components

The following are the typical components of an IP Office system.

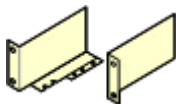
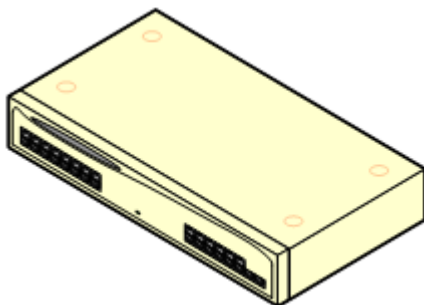
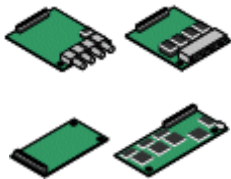
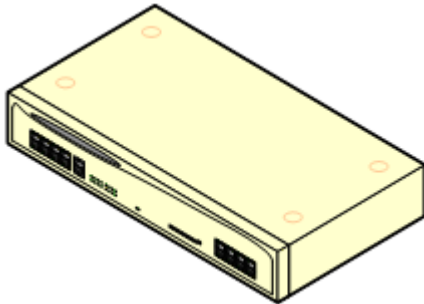

- **[IP Office IP400 Control Unit](#)**
The control unit holds the main configuration and performs the routing and switching for telephone calls and data traffic. Each control unit includes LAN ports, slots for additional internal cards and in some cases integral digital and analog phone ports. IP Office 4.0 supports the following IP400 control units:
- **[IP406 V2](#)**
Includes 8 integral digital extension ([DS](#)) ports, 2 analog phone ports and an 8 port ethernet LAN switch. Can be expanded by the addition of up to 6 [external expansion modules](#).
- **[IP412](#)**
Includes a 2 port ethernet switch. Can be expanded by the addition of up to 12 [external expansion modules](#).
- **[Trunk Cards](#)**
Each IP400 control unit supports the addition of two IP400 trunk cards.
- **[Internal Cards](#)**
Additional cards can be added to the IP400 control units for features such as modem ports and voice compression channels (used for VoIP).
- **[Embedded Voicemail Memory Card](#)**
The IP460 V2 supports IP Office embedded voicemail by the addition of an Embedded Voicemail memory card.
- **[IP400 External Expansion Modules](#)**
Additional extension and trunk ports can be added using a number of external expansion modules. The number supported depends on the control unit type and the module type.
- **[Power Supplies](#)**
Each IP400 Office control unit and external expansion module is supplied with an external power supply unit. Additional power supply units may also be required for IP phones and some phone add-ons.
- **[Power Cords](#)**
Depending on the locale, different power cords need to be ordered for each control unit, external expansion module and any phones or devices using external power supply units.
- **[Cables](#)**
The IP Office is designed primarily for connection to a structured cabling system using CAT3 UTP cabling. This approach allows telephone and data traffic to share the same wiring infrastructure and simplifies equipment moves.
- **[IP400 Rack Mounting Kit](#)**
The IP400 control units and expansion modules are designed to be stacked free-standing. However they can also be rack mounted using an optional rack mounting kit for each unit and module.
- **[Surge Protectors and Barrier Boxes](#)**
Where the installation includes extensions in other buildings additional protective equipment is required. This equipment may also be required in areas where the lightning risk is high.
- **[Phones](#)**
IP Office systems support a variety of Avaya digital and IP phones plus analog phones.

VK00nDd15SDvXoxkw9cR9x_jOXr_AWz9

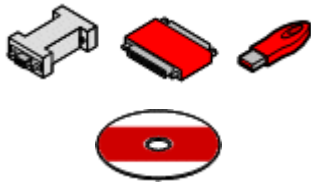

- **License Keys**
Various IP Office features and applications require a license key to be entered into the system's configuration. Each key is a 32-character text string unique to the feature being activated and the serial number of the Feature Key dongle (see below) installed in the system.
- **Feature Key Dongle**
A uniquely numbered dongle used to validate license keys. Several different types of Feature Key dongle are available.
- **Application CD's/DVD's**
The IP Office applications can be ordered on a number of CD's. In addition they can be downloaded from the IP Office section of the Avaya support web site (<http://support.avaya.com>).

2.3 IP500 Office System Components

The following are the typical components of an IP Office IP500 system.

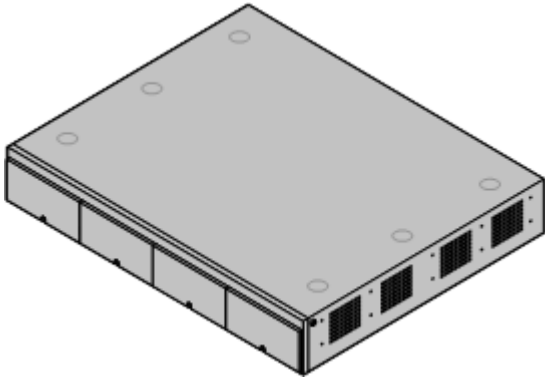

- **[IP Office IP500 System Unit](#)**
The control unit holds the main configuration and performs the routing and switching for telephone calls and data traffic. Each control unit includes LAN ports, slots for additional internal cards and in some cases integral digital and analog phone ports.

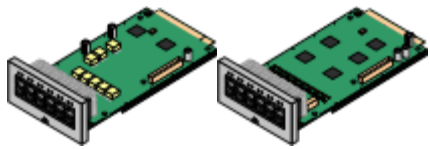

- **[IP500 Base Cards](#)**
The IP500 control unit has slots for up to 4 IP500 base cards. These can be used to add analog extension port, digital extension ports, voice compression channels and some legacy IP400 cards.

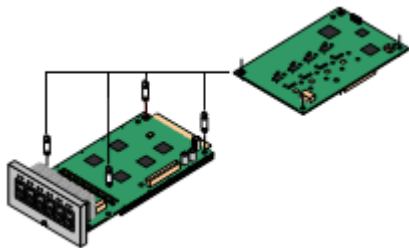

- **[IP500 Trunk Daughter Cards](#)**
Many of the IP500 base cards can be fitted with a IP500 daughter card in order to support various types of trunk connections.

- **[IP500 Analog Trunk Card](#)**
- **[IP500 BRI Trunk Card](#)**
- **[IP500 PRI Trunk Card](#)** (*IP Office 4.1+*)

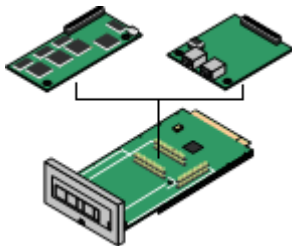

- **[IP400 Cards](#)**
The IP500 Legacy Carrier base card can be used to allow IP400 trunk cards and IP400 VCM cards to be added to the IP500 control unit.

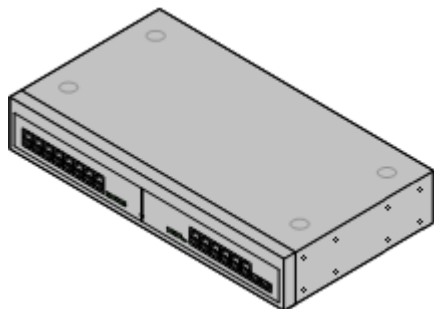

- **[IP500 External Expansion Modules](#)**
Additional analog and digital extension ports can be added using a number of IP500 external expansion modules.
 - To support external expansion modules an **IP500 Upgrade Standard to Professional** license is required.
 - Support includes IP400 external expansion modules except for WAN3 modules.



- **[Power Supplies](#)**
The IP500 control unit has an internal power supply unit. Each external expansion module is supplied with an external power supply unit. Additional power supply units may also be required for IP phones and some phone add-ons.

- **[Power Cords](#)**
Depending on the locale, different power cords need to be ordered for each control unit, external expansion module and any phones or devices using external power supply units.

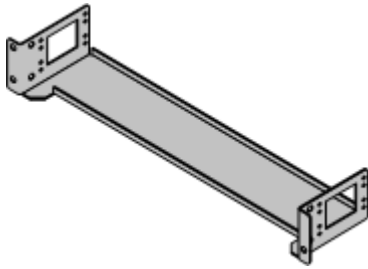

VK00nDd15SDvXoxkw9cR9x_jOXr_AWz9



- **Cables**

The IP Office is designed primarily for connection to a structured cabling system using CAT3 UTP cabling. This approach allows telephone and data traffic to share the same wiring infrastructure and simplifies equipment moves.

- **Mounting Kits**

The IP500 control unit can be used free-standing, with external expansion modules stacked above it. With optional rack mounting kits, the control unit and external expansion modules can also be rack mounted. Alternatively with an optional wall mounting kit the IP500 control unit can be wall mounted.

- **Surge Protectors and Barrier Boxes**

Where the installation includes extensions in other buildings additional protective equipment is required. This equipment may also be required in areas where the lightning risk is high.

- **Phones**

IP Office systems support a variety of Avaya digital and IP phones plus analog phones.

- **License Keys**

Various IP Office features and applications require a license key to be entered into the system's configuration. Each key is a 32-character text string unique to the feature being activated and the serial number of the Feature Key dongle (see below) installed in the system.

- **Feature Key Dongle**

A uniquely numbered dongle used to validate license keys. For the IP500 control unit a Smart Card type Feature Key dongle is mandatory for correct system operation even if no licensed features are being used.

- **Application CD's/DVD's**

The IP Office applications can be ordered on a number of CD's. In addition they can be downloaded from the IP Office section of the Avaya support web site (<http://support.avaya.com>).

2.4 Control Units

The base of any IP Office system is the system or control unit. It stores the system configuration and controls the system operation.

Each control unit can be customized by adding various [internal cards](#) such as trunk cards. Except for the Small Office Edition control unit, External expansion modules can be also be connected to add additional extension and trunk ports.

IP Office 4.1 supports the following IP Office control units.

- **[IP500 System Unit](#)**

This control unit has four front slots for IP500 base cards. It has an internal power supply unit and uses a mandatory credit-card sized Smart Card Feature Key dongle. It includes a 2 port ethernet LAN switch (layer 3 managed) on the rear. The unit runs in two modes; IP Office Express Edition and IP Office Professional Edition.

- **[IP Office Standard Edition](#)** is the default mode for the IP500 control unit. In this mode it support only 32 users, no external expansion modules and the basic IP Office applications.

- By addition of a license the IP500 can be run in IP Office Professional Edition mode. In this mode it supports up to 272 extensions, 8 external expansion modules and the full suite of IP Office applications.

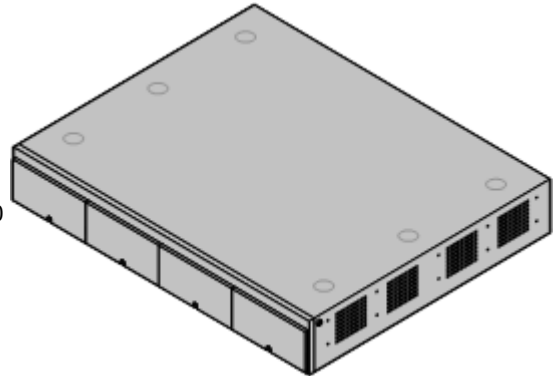

- **[IP412 Control Unit](#)**

This unit supports 2 IP400 trunk cards of any type. Up to 12 external expansion modules can be added plus 2 WAN3 10/100 modules. It includes a 2 port ethernet LAN switch (layer 3 managed).

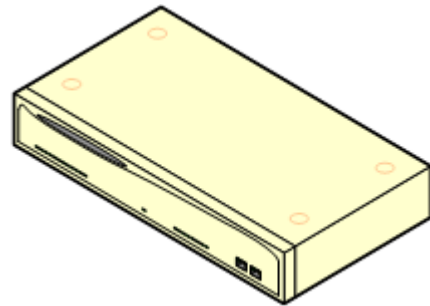

- **[IP406 V2 Control Unit](#)**

This unit supports up to 6 external expansion modules plus 2 WAN3 10/100 modules. It supports 2 IP400 trunk cards of all types though only one may be a dual PRI trunk card. The unit has 8 Avaya digital [DS](#) phone ports and 2 [analog](#) phone ports plus an 8 port ethernet LAN switch (layer 2 unmanaged).

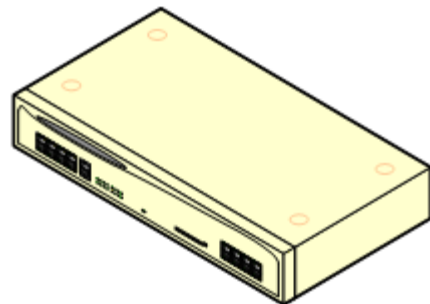

- **[Small Office Edition Control Unit \(SOE\)](#)**

This is a single unit IP Office system. It does not support any external expansion card modules and only supports a single IP400 trunk interface card. However the Small Office is available in a number of models, with differing numbers of integral analog trunk, analog extension and Avaya [DS](#) phone ports. The modules all have a 4 port ethernet LAN switch (layer 2 unmanaged) and an Ethernet WAN port.

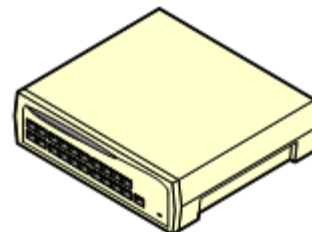

2.5 Control Unit Summary

The following table summarizes the IP Office control units.

Feature	Small Office Edition	IP406 V2	IP412	IP500
Digital Station (DS) Ports	0 or 8	8	0	Up to 24
Analog Phone (PHONE) Ports	2 or 4	2	0	Up to 32
Optional Embedded Voicemail Card Slot	✓	✓	✗	✓
Integral WAN Port	✗	✓	✓	✗
Expansion Ports	0	6	12	8
DTE Port	9-way	9-way	9-way	9-way
Audio In (MOH) Port	✓	✓	✓	✓
External O/P Switch Port	✓	✓	✓	✓
Conference Parties*	24	64	128	64
Configuration Memory	192KB	256KB	1024KB	1024KB
Voicemail Pro/TAPI WAV Channels	10	20	30	30
Maximum Extension Capacity	28	190	360	272
- Digital (DS) Phones only.	8	188	360	264
- Analog Phones only.	4	182	360	272
- IP Phones only.	16	190	360	272
IP400 Trunk Cards Supported	1	2	2	2
- Analog trunk cards	✗	✓	✓	✓
- Quad BRI trunk cards	✓	✓	✓	✓
- Single PRI trunk cards	✓ (T1)	✓	✓	✓
- Dual PRI trunks cards	✗	✓ (Slot A)	✓	✓
- WAN port card	✓	✗	✗	✗
IP500 Trunk Daughter Cards	0	0	0	4
- IP500 Analog trunk cards	✗	✗	✗	✓
- IP500 BRI trunk cards	✗	✗	✗	✓
- IP500 PRI trunk cards	✗	✗	✗	✓
VCM Cards				
- IP400 VCM Cards	✗	1	2	2
- IP500 VCM Cards	✗	✗	✗	2
Maximum voice compression channels	3 or 16	30	60	128
Dimensions				
Height x Width x Depth	76x255x241mm 3"x10"x9.5"	71x445x245mm 2.8"x17.5"x9.7"		73x445x365mm 2.9"x17.5"x14.4"

*Note

1. The Small Office Edition is restricted to 6 callers in any particular conference.
2. Where IP Office Conferencing Center is installed, 5 conference slots are reserved by the control unit for its own use (call recording, etc) and are not available to IP Office Conferencing Center or for general conference usage.

2.6 IP Office Standard Edition

The IP500 system unit start operation in a mode called IP Office Standard Edition mode. In this mode, the number and range of features supported is limited. The limitations can be overridden by the addition of and IP500 Upgrade Standard to Professional license to the IP Office 500 configuration. Features not detailed in the table below are not affected directly by Standard Edition or Professional Edition mode selection.

Feature	Standard Edition	Professional Edition
Extensions	32	272
External Expansion Modules	✗	✓
Applications		
Phone Manager (All modes)*	✓	✓
SoftConsole *	✓	✓
IP Office TAPI	✓	✓
Delta Server	✓	✓
Compact Business Center (CBC)	✓	✓
Compact Contact Center (CCC)*	✗	✓
Embedded Voicemail	✓	✓
Voicemail Lite	✗	✓
Voicemail Pro *	✗	✓
ContactStore *	✗	✓
Conference Center *	✗	✓
MS-CRM	✗	✓
Meet-me Conferences	✗	✓
IP DECT Trunks	✓	✓
SIP Trunks *	✓	✓
SES Trunks *	✓	✓

*Also require appropriate application licenses.

The following licences are specific to IP Office 500 systems.

- IP500 Upgrade Standard to Professional**
 This license is required for an IP500 system to run in IP Office Professional Edition mode rather than IP Office Standard Edition mode. It is a pre-requisite for any licensed features not supported in Standard Edition mode.
- IP500 Voice Networking (Base 4 channels)**
 For IP500 systems this licences enables support for H323 IP trunks between IP Office systems and QSIG or Small Community Networking over those trunks.
- IP500 Voice Networking (Additional channels)**
 Allows an additional 4 H323 voice networking trunks.
 - For IP Office 4.0, the IP500 Voice Networking licenses were only supported in IP Office Professional Edition mode. For IP Office 4.1 they are supported in IP Office Standard and Professional Edition modes.
- IP500 PRI Trunk Channels**
 Each IP500 PRI-U trunk daughter card provides 8 channels by default. Additional channels are enabled by the addition of the type of license.

2.7 IP500 Base Cards

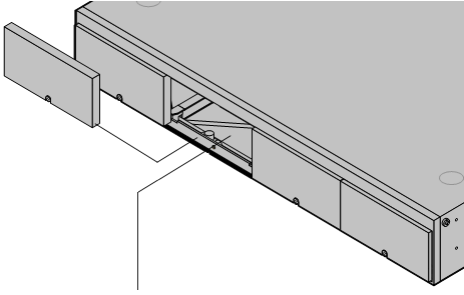

The IP500 control unit has 4 slots for the insertion of base cards. Each base card includes an integral front panel with ports for cable connections.

The slots are numbered 1 to 4 from left to right. They can be used in any order. However if the capacity for a particular type of card is exceeded, the card in the highest slot will be disabled.

[IP500 Digital Station Base Card](#)

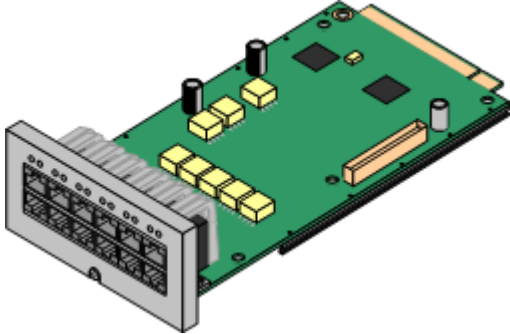

This card has 12 RJ45 ports. The first 8 ports are [DS](#) ports for the connection of Avaya digital phones other than IP phones. The card can be fitted with an IP500 daughter card which then uses the additional 4 RJ45 ports for connections.

- This card accepts one IP500 daughter card of any type.
- Maximum: 3 per IP500 control unit.
- 4400 Series phones (4406D, 4412D and 4424D) are not supported.

[IP500 Analog Phone Base Card](#)

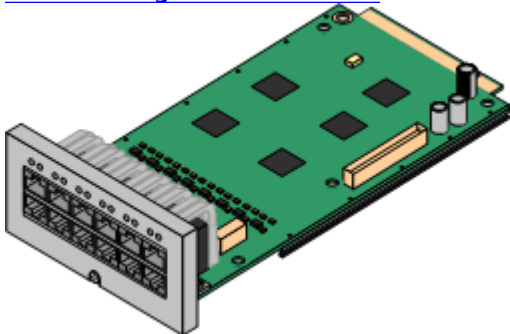

This card has 12 RJ45 ports. The card is available in two variants, providing 2 or 8 analog extension ports for the connection of analog phones. The card can be fitted with an IP500 daughter card which then uses the additional 4 RJ45 ports for connections.

- This card accepts one IP500 daughter card of any type.
- Maximum: 4 per IP500 control unit.
- When fitted with an IP500 Analog Trunk daughter card, the Phone 8 base card supports 1 power failure extension to trunk (loop-start only) connection.
- The analog extension ports do not include a ringing capacitor. Where this is a requirement, connection should be via a Master socket containing ringing capacitors.

IP500 VCM Base Card

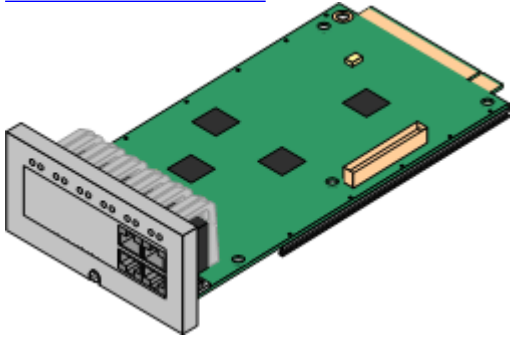

This card provides voice compression channels for use with VoIP calls. The module is available in variants supporting up to 32 or 64 channels. Each card provides 4 initial channels with additional channels being enabled by licenses in the IP Office configuration. The card can be fitted with an IP500 daughter card which then uses the 4 RJ45 ports for connections.

The maximum number of voice compression channels supported, using IP500 VCM cards and or IP400 VCM cards on IP500 carrier cards, is 128.

- This accepts one IP500 daughter card of any type.
- Maximum: 2 per IP500 control unit.

IP500 Legacy Card Carrier Base Card

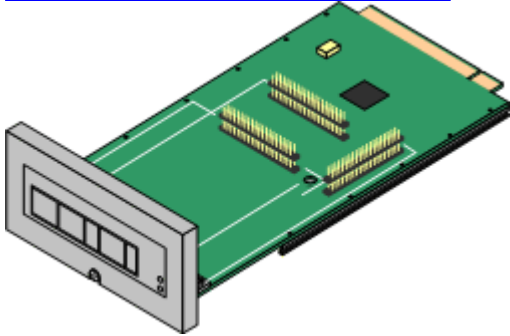

This card allows a various IP400 trunk and VCM cards to be used with the IP500 control unit. The front of the card includes a number of panels that can be snapped off to match the ports when a trunk card being fitted.

- This card does not accept an IP500 daughter card.
- Maximum: 2 per IP500 control unit.
- IP400 Cards Supported: The following cards are supported. Any card not listed is not supported.

- | | |
|----------------------|------------------------|
| ✓ PRI T1 | ✓ BRI-8 (UNI) |
| ✓ Dual PRI T1 | ✓ ANLG 4 Uni (US only) |
| ✓ PRI 30 E1 (1.4) | ✓ VCM 4 |
| ✓ Dual PRI E1 | ✓ VCM 8 |
| ✓ PRI 30 E1R2 RJ45 | ✓ VCM 16 |
| ✓ Dual PRI E1R2 RJ45 | ✓ VCM 24 |
| | ✓ VCM 30 |

2.8 IP500 Trunk Cards

Updated for IP500 PRI-U trunk daughter card. Need to add accurate picture of card and also update fitting picture for the new pillar arrangement.

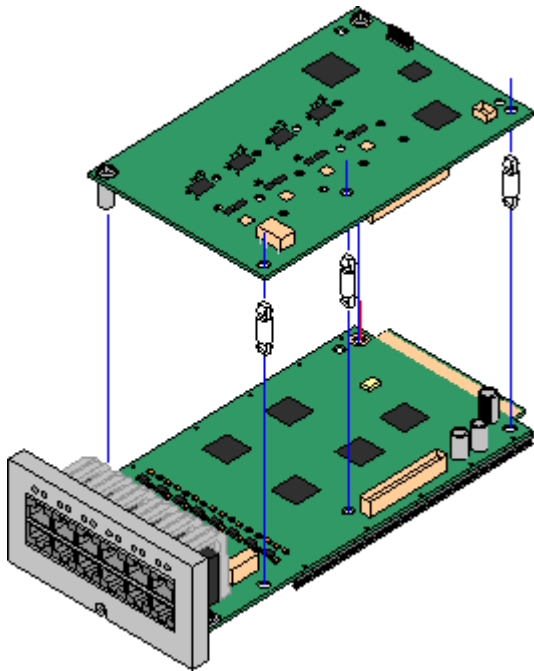

IP500 daughter trunk cards can be fitted to IP500 base cards to provide support for trunk. The daughter card uses the physical ports provided on the front panel of the base card for cable connection.

The addition of an IP500 daughter card is supported on any IP500 base card except the IP500 Legacy Card Carrier base card.

For those base card that support daughter cards, there are no restrictions on the combination of card types. However in systems with both analog phone base cards and analog trunk daughter cards, combining the two type is recommended as it then provides analog power failure support for one trunk/extension.

Each daughter card is supplied with the stand off pillars required for installation and a label to identify the cards presence on the physical unit once installed.

• **Note: Change to Installation**

With the introduction of the IP500 PRI-U trunk daughter card, the 5 plastic stand off pillars supplied with these card were changed. All trunk daughter cards are now supplied with two pre-fitted metal pillars and 3 plastic pillars. Two screws and washers for final attachment of the metal pillars to the base card are also included. This change does not affect existing cards supplied with 5 plastic pillars.

IP500 Analog Trunk Daughter Card

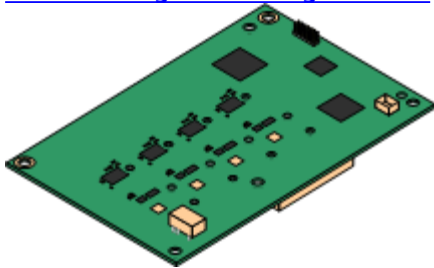

This card can be added to an IP500 base card except the IP500 Legacy Card Carrier base card. It allows that base card to then also support 4 analog loop-start trunks.

- When fitted to an IP500 Analog Phone 8 base card, the combination supports 1 power failure extension to trunk (loop-start only) connection.
- Maximum: 4 per IP500 control unit.

IP500 BRI Trunk Daughter Card

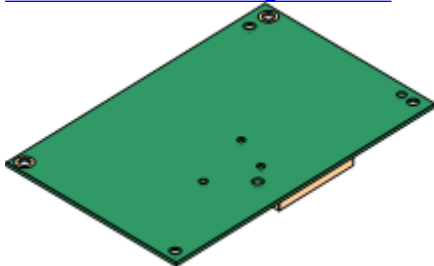

This card can be added to an IP500 base card except the IP500 Legacy Card Carrier base card. It allows that card to then also support up to 4 BRI trunk connections, each trunk providing 2B+D digital channels. The card is available in 2 port (4 channels) and 4 port (8 channels) variants.

- Maximum: 4 per IP500 control unit.
- S-Bus Connection: On IP Office 4.2+ systems, the card can be switched from To trunk mode to So mode. This mode requires additional terminating resistors and an ISDN crossover cable connection, see [BRI Port \(So\)](#).

IP500 PRI-U Trunk Daughter Card

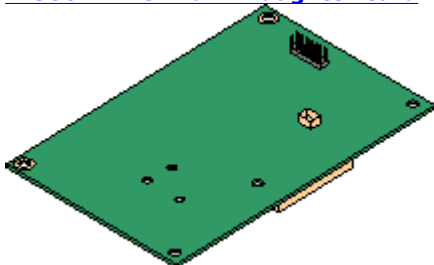

This card can be added to an IP500 base card except the IP500 Legacy Card Carrier base card. The card is a universal card that can be configured in software for E1 PRI, T1 robbed bit, T1 PRI or E1R2. The card is available in single and dual port variants.

- Maximum: 4 per IP500 control unit.
- The IP500 PRI-U card supports E1, T1 and E1-R2 PRI modes. The IP Office system supports 8 unlicensed B-channels on each IP500 PRI-U port fitted. Additional B-channels, up to the capacity of ports installed and PRI mode selected require **IP500 Universal PRI (Additional Channels)** licenses added to the configuration. These additional channels consume the licenses based on which additional channels are configured as in-service from port 9 of slot 1 upwards. D-channels are not affected by licensing.

2.9 IP400 Trunk Cards

A range of IP400 trunk cards are available for different trunk types. Each IP400 trunk card is supplied with stand off pillars and a replacement blanking plate for use with IP400 control units.

- **Small Office Edition Control Units**

All versions of the Small Office Edition control include either two or four integral analog trunk ports on the front of the unit. In addition a single IP400 trunk card can be fitted to the rear of the unit.

- **IP400 Control Units**

The IP406 V2 and IP412 can be fitted with up to 2 IP400 trunk cards. Except where otherwise indicated, it is recommended that Slot B is used first.

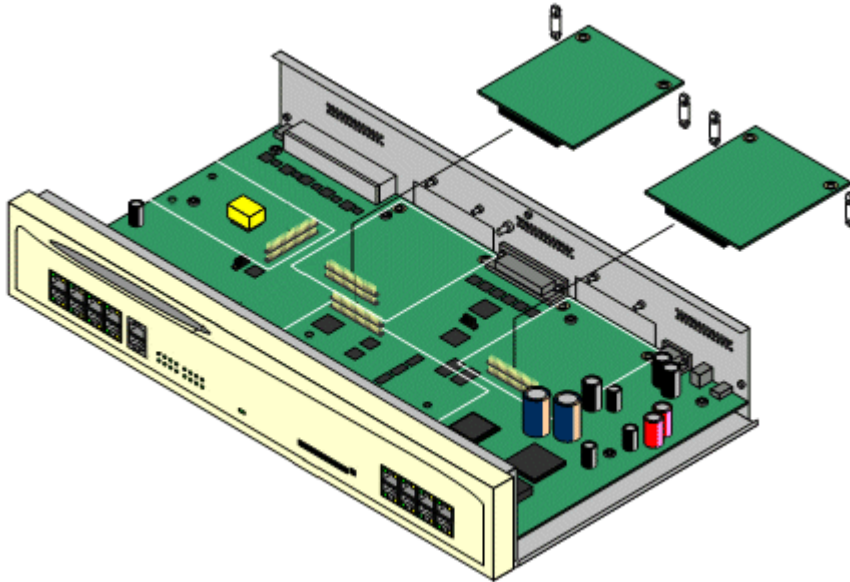

- **IP500 Control Unit**

The IP500 control unit can accept up to two IP400 trunk cards by mounting each card on an IP500 Legacy Card Carrier base card.

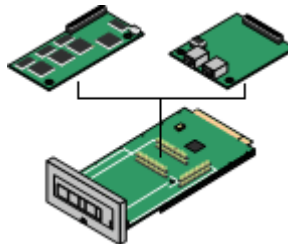

The following IP400 trunk card types are supported by IP Office 4.0:

IP400 Trunk Cards		SOE	IP406 V2	IP412	IP500
	<p>Analog Trunk Card (ATM4) Provides 4 RJ45 loop-start analog trunk ports. The card is available in several locale specific variants. This card has been superseded by the ATM4U card below.</p> <p>Additional loop or ground start analog trunks can also be added using Analog Trunk external expansion modules.</p>	X	✓	✓	✓
	<p>Analog Trunk Card (ATM4U) Provides 4 RJ45 loop-start analog trunk ports as per the ATM4 above but available in a single worldwide variant. Also supports adjustable echo cancellation on IP Office 3.1.</p> <p>Additional loop or ground start analog trunks can also be added using Analog Trunk external expansion modules.</p>	X	✓	✓	✓
	<p>Quad BRI Trunk Card Provides support for 4 RJ45 BRI (2B+D) trunk ports. These can be configured to ETSI or AusTS013 operation. The ports include 100ohm termination.</p>	✓	✓	✓	✓
	<p>Single PRI T1 Trunk Cards Supports PRI (23B+D) trunks and T1 Robbed-Bit (24B) trunks through a single RJ45 port. The mode of operation is selected in the IP Office configuration.</p>	✓	✓	✓	✓
	<p>Single E1 PRI Trunk Cards Supports PRI (30B+D) trunks through a single RJ45 port. The port can be configured for PRI or QSIG operation.</p>	X	✓	✓	✓
	<p>Single E1R2 Trunk Cards Supports PRI (30B+D) trunks using E1R2 signalling. Available in coaxial or RJ45 connector variants. Coaxial variants are not supported on an IP500 carrier card.</p>	X	✓	✓	✓
	<p>Dual PRI Trunk Cards As the single PRI cards above but supporting the connection of two PRI trunks. On the IP406 V2, supported in Slot A only.</p>	X	✓	✓	✓
	<p>WAN Port Card Used only with the Small Office Edition. Provides a single 37-way D-type socket for connection to a V.24, V.35 or X.21 WAN service. Includes a replacement back panel for the control unit.</p>	✓	X	✓	X

2.10 External Expansion Modules

Updated to include the new IP500 face lifted expansion modules.

These modules can be used to add additional ports to an IP400 and IP systems. The number of expansion modules supported depends on the control unit type.

Expansion modules, except the WAN3 10/100 module, connect to expansion ports on the rear of the control unit, using a 1 meter (3'3") cable supplied with the expansion module. No other cable should be used. The WAN3 10/100 module differs in that it connects via a LAN port on its front to one of the control unit's LAN ports.

Each module uses an external [power supply unit](#) supplied with the module. A locale specific [power cord](#) for the PSU must be ordered separately.

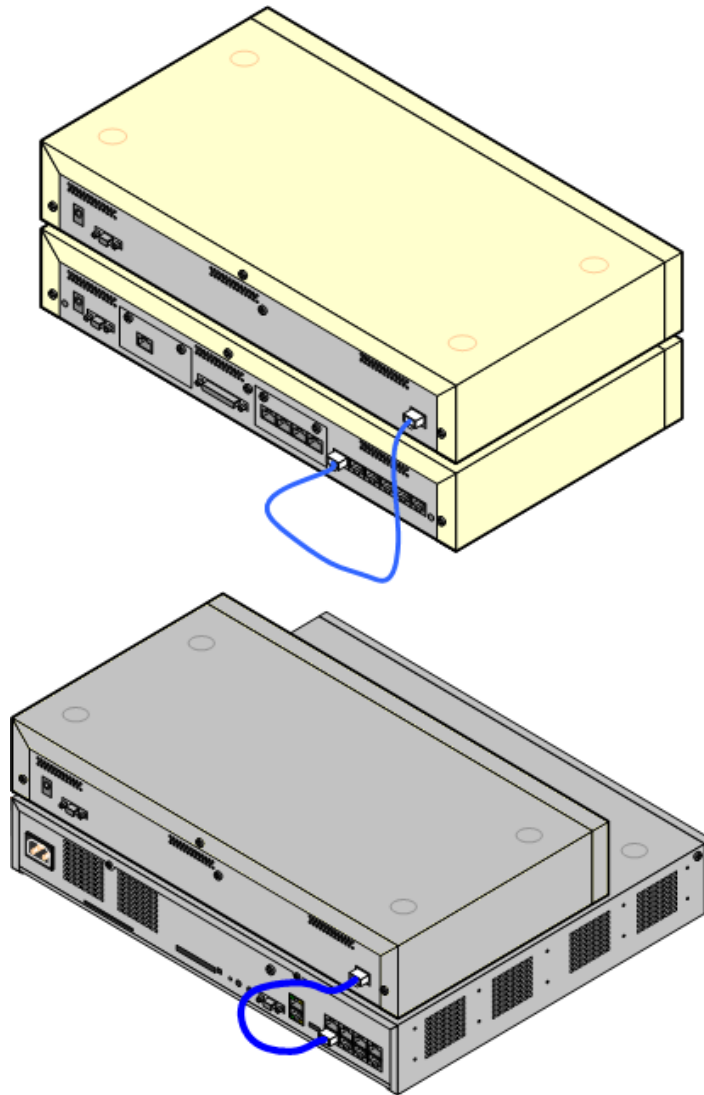

Number of modules supported:	Small Office Edition	IP406 V2	IP412	IP500
WAN3 10/100 modules.	✗	2	2	✗
All other modules.	✗	6	12	8

- The IP500 control unit only supports external expansion modules when running in IP Office Professional Edition mode. IP500 control units running in IP Office Standard Edition mode do not support any external expansion modules.

IP500 External Expansion Modules

The following IP500 external expansion modules are supported by IP Office 4.2. They are intended for use with an IP500 control unit running in IP Office Professional Edition mode but can also be used with IP400 control units.

Unlike IP400 external expansion modules these units use the IP500 rack mounting kit.

- **IP500 Analog Trunk Module**

Provides an additional 16 [ANALOG](#) ports for connection of analog trunks. Supports both loop-start and ground-start trunks.

- Currently only available for the US locale.
- Use with ground start trunks requires that the trunk module and the IP Office control unit are grounded.

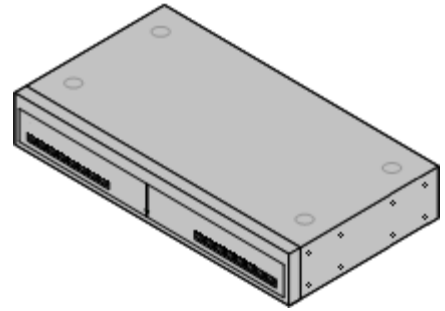

- **IP500 BRI So8 Module**

Provides 8 ETSI [BRI-So ports](#) for the connection of ISDN devices. This unit is not intended to support BRI trunks.

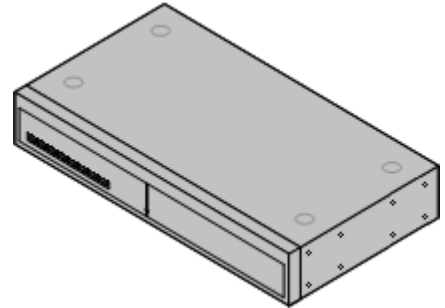

- **IP500 Digital Station Module**

Provides, depending on variant, an additional 16 or 30 [DS](#) ports for supported [Avaya digital phones](#).

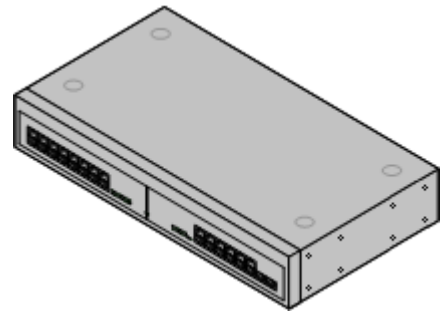

- **IP500 Phone Module**

Provides, depending on variant, an additional 16 or 30 [PHONE](#) ports for analog phones.

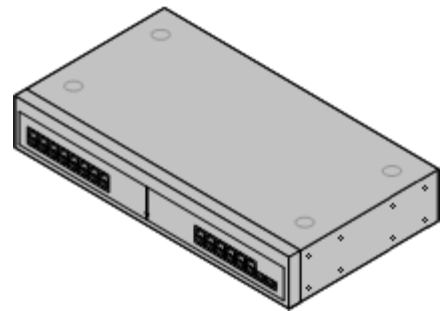

IP400 External Expansion Modules

The following IP400 external expansion modules are supported by IP Office 4.2. Except for the WAN3 10/100, these modules can also be used with an IP500 control unit running in IP Office Professional Edition mode.

- **[IP400 Analog Trunk Module \(ATM16\)](#)**

Provides an additional 16 [ANALOG](#) ports for connection of analog trunks. Supports both loop-start and ground-start trunks.

- Available in a number of variants for different locales.
- Use with ground start trunks requires that the trunk module and the IP Office control unit are grounded.

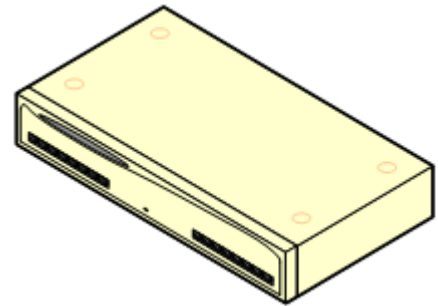

- **[IP400 Digital Station Module \(DS16/DS30\)](#)**

Provides, depending on the variant, an additional 16 or 30 [DS](#) ports for supported Avaya digital phones. This module has been superseded by the Digital Station V2.

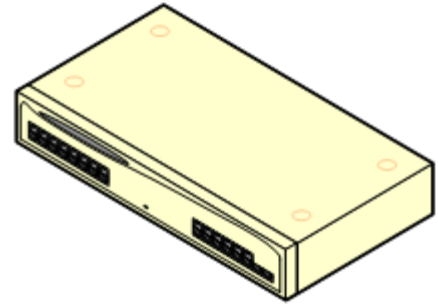

- **[IP400 Digital Station Module V2 \(DS16 V2/DS30 V2\)](#)**

Provides, depending on variant, an additional 16 or 30 [DS](#) ports for supported [Avaya digital phones](#). Supersedes the previous Digital Station module.

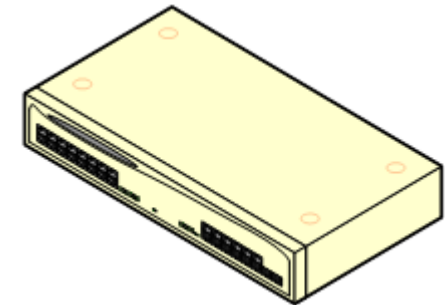

- **[IP400 Phone Module \(Phone8/Phone16/Phone30\)](#)**

Provides, depending on variant, an additional 8, 16 or 30 [POT](#) ports for analog phones. This module has been superseded by the Phone Module V2.

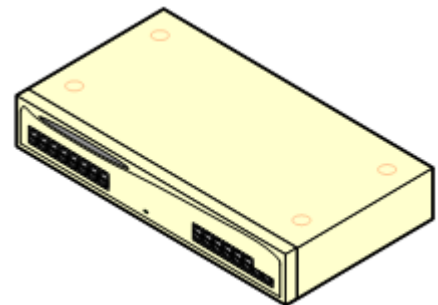

- **[IP400 Phone Module V2 \(Phone8 V2/Phone16 V2/Phone30 V2\)](#)**

Provides, depending on variant, an additional 8, 16 or 30 [PHONE](#) ports for analog phones. Supersedes the previous Phone module. With IP Office 3.1, the Phone V2 supports a wider range of message waiting indication (MWI) options than Phone V1 modules.

- With V2 units, the labeling of analog phone ports was changed from POT to PHONE.

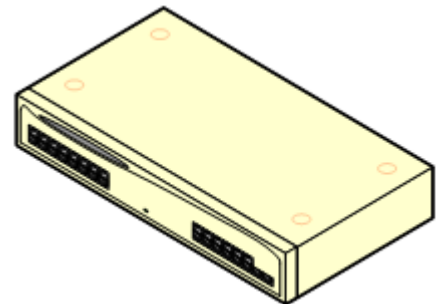

- **IP400 So8 Module**

Provides 8 ETSI [BRI-So](#) ports for the connection of ISDN devices. This unit is not intended to support BRI trunks.

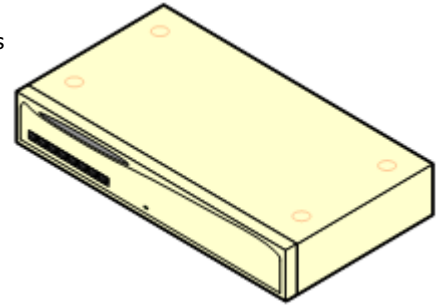

- **IP400 WAN3 10/100 Module**

Provides on its rear an additional three 37-way [D-type WAN](#) ports. These can be used for the connection of [V.24](#), [V.35](#) and [X.21](#) WAN services. The module connects to the control unit via a LAN port rather than an expansion port.

- The WAN3 has been superseded by the WAN3 10/100 and is not supported by IP Office 3.2 and higher.
- IP Office systems are restricted to a maximum of 2 WAN3 modules regardless of the control unit type.
- This module is not supported with the IP500.

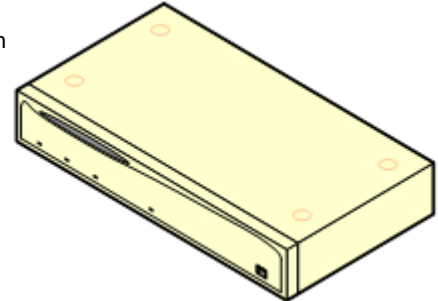



2.11 Other Cards

Each IP Office control unit can be fitted with a number of internal cards. The cards supported depend on the control unit type.

Modem Cards



These cards provide modem circuits to answer incoming V.90 analog modem calls.

- The first analog trunk on control units fitted with analog trunks can be set to answer V.32 analog modem calls. Whilst in this mode, the trunk cannot be used for voice calls.

Modem Cards	SAP Code	Small Office Edition	IP406 V2	IP412	IP500
Internal Modem Card/Modem 12: Provides 12 V.90 modem channels, 4 only in the IP403 control unit.	700343452	✗	✓	✓	✗
Modem 2 Card: Provides 2 V.90 modem channels.	700185226	✗	✓	✓	✗

Embedded Voicemail Memory Cards



These cards provide message and prompt storage space for embedded voicemail and auto-attendant options. The cards used are specially formatted compact flash cards.

Embedded Voicemail Memory Cards	SAP Code	Small Office Edition	IP406 V2	IP412	IP500
Small Office Edition Memory Card: Supports a 64Mb Compact Flash card fitted in a PCMCIA slot caddy. This provides up to 10 hours of compressed message and prompt storage. Compression uses voice compression channels during usage.	700289721	✓	✗	✗	✗
IP406 V2 Memory Card: Supports a 512MB Compact Flash card. This provides up to 15 hours of uncompressed message storage.	700343460	✗	✓	✗	✓

- Memory cards in these slots can also be used for storage of files normally obtained via TFTP transfer. For example the music-on-hold .wav file and supported 4600 Series/5600 Series software files. This will however reduce storage space for prompt and message files if embedded voicemail is being used.
- IP Office systems that have downloaded an internal music on hold source can then backup and restore that music on hold to and from the memory card.
- Non-Avaya cards can be used for file storage but will not support Embedded Voicemail.

Small Office Edition Wireless Card

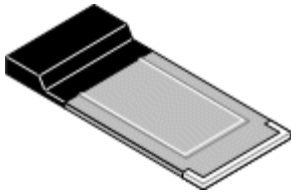

The Small Office Edition supports an Avaya supplied 802.11b WiFi wireless card. This allows the control unit to act as a wireless access point.

Wireless Card	SAP Code	Small Office Edition	IP406 V2	IP412	IP500
Wireless Card	700289739	✓	✗	✗	✗

IP400 Voice Compression Modules

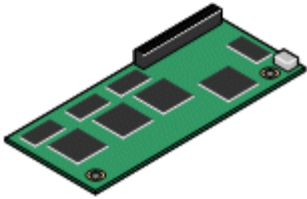

VCM cards are used to provide voice compression channels for calls between IP and non-IP devices, devices being both trunks and extensions. VCM cards with differing numbers of voice compression channels are available.

- For the Small Office Edition control unit, either 3 or 16 voice compression channels with 40ms echo cancellation are pre-built into the module. These cannot be changed.
- For IP500 control units, voice compression channels can be added using either IP400 VCM modules mounted on a IP500 Carrier Card or using IP500 VCM cards.

VCM Cards		SAP Code	Small Office Edition	IP406 V2	IP412	IP500
25ms echo cancellation.	IP400 VCM5*	700185119	✗	✓	✓	✗
	IP400 VCM10*	700185127	✗	✓	✓	✗
	IP400 VCM20*	700185135	✗	✓	✓	✗
	IP400 VCM30	700293939	✗	✓	✓	✓
64ms echo cancellation.	IP400 VCM4	700359854	✗	✓	✓	✓
	IP400 VCM8	700359862	✗	✓	✓	✓
	IP400 VCM16	700359870	✗	✓	✓	✓
	IP400 VCM24	700359888	✗	✓	✓	✓
Number of IP400 VCM cards.			0	1	2	2
Maximum number of channels.			3/16	30	60	128

- *These modules are still supported but are no longer available from Avaya.

2.12 Power Supplies

The IP500 has an internal power supply unit and so only requires a suitable locale specific power cord.

Small Office Edition, IP406 V2, IP412 control units and external expansion modules are all supplied with an external power supply unit (PSU). These external power supply units include an integral 1.5 meter lead for connection to the control unit or expansion module. A [power cord](#) for connection from the PSU to the power outlet is not included as this varies by locale. The appropriate power cord must be ordered separately or sourced locally.

Additional power supply units are required for 4450, EU24, XM24 and T3 DSS add-on modules and may also be required for 4600 Series/5600 Series IP phones.

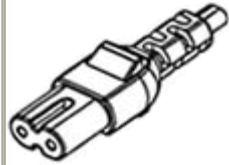
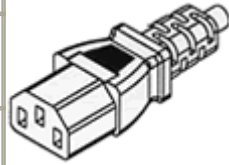
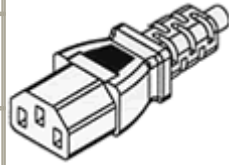
Area	Type	Used on:	Connector Type
IP Office Control Units and External Expansion Modules	40W PSU	Analog, Digital Station V1, Phone V1.	IEC60320 C7 
	45W Earthed PSU	Small Office Edition.	IEC60320 C13
	60W Earthed PSU	IP406 V2, IP412, IP400 Digital Station V2, IP400 Phone V2, IP400 So8, IP400 WAN3 10/100, IP500 Phone 30, IP500 Digital Station 30.	
IP Phones and Phone Add-Ons	1151D1	All phones with XM24 Phone add-ons.	
	1151D2	All phones with EU24/EU24BL Phone add-ons unless using Class 3 PoE. 4600 and 56000 Series IP Phones when not using a PoE.	
	1600PWR 5V	Plug-top PSU used with 1600 Series phones on IP Office when not being power using PoE.	Various country variants.

- Some units previously supplied with a 40W unearthed PSU are now approved for and supplied with a 60W earthed PSU. That changes affects the IP412, So8 and WAN3 10/100 units.
- The 1151D2 is the same as the 1151D1 except that it includes a backup battery that is charged during normal operation. This can provide typically 15 minutes backup at maximum load (20 Watts) and up to 8 hours at light load (2 Watts).
- Avaya 4600 Series and 5600 Series can use IEEE 802.3af Power over Ethernet (PoE) power supplies. Refer to the IP Office IP Phone Installation Manual for full details.

2.13 Power Supply Cords

Each control unit and expansion module requires a switched power outlet socket rated at 110-240V ac, 50-60Hz. Connection from that power outlet socket requires an appropriate locale specific power cord which is not supplied with the unit and must be ordered separately.

Power cords must not be attached to the building surface or run through walls, ceilings, floors and similar openings. Installation measures must be taken to prevent physical damage to the power supply cord, including proper routing of the power supply cord and provision of a socket outlet near the fixed equipment or positioning of the equipment near a socket outlet.

For locales not detailed below an appropriate power cord must be obtained locally.

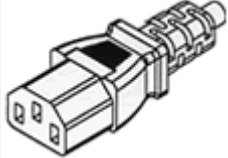
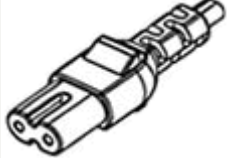
Power Cord Type	Power Outlet Plug Type	Locales	SAP Codes
Earthed Power Cords (IEC60320 C13)  Control Units <ul style="list-style-type: none"> • IP500. • IP406 V2. • IP412.* • Small Office Edition. IP400 External Expansion Modules <ul style="list-style-type: none"> • Digital Station V2. • Phone V2. • So8.* • WAN3 10/100.* IP500 External Expansion Modules <ul style="list-style-type: none"> • BRI So8. • Digital Station 16/30. • Phone 16/30. 	CEE7/7 (Schuko)	Europe and South Africa.	700289762
	BS1363	Czech Republic, Ireland, United Kingdom.	700289747
	NEMA5-15P / CS22.2 No.42	North, Central and South America.	700289770
	CPCS-CCC	China.	700261977
	Unearthed Power Cord (IEC60320 C7)  IP400 External Expansion Modules <ul style="list-style-type: none"> • Analog. • Digital Station V1. • Phone V1. IP500 External Expansion Modules <ul style="list-style-type: none"> • Analog Trunk 16. 	CEE7/16 (Europlug)	Europe and South Africa.
BS1363		Czech Republic, Ireland, United Kingdom.	700213374
NEMA1-15		North, Central and South America.	700213390
		Korea.	700254519
		China.	700314172

*Older units were supplied with a 40W unearthed PSU and required an IEC60320 C7 power cord.

2.14 Power Supply Backup

The use of an Uninterrupted Power Supply (UPS) with any telephone system is recommended. Even at sites that rarely lose electrical power, that power may occasionally have to be switched off for maintenance of other equipment. In addition, most UPS's also provide an element of power conditioning, reducing spikes and surges.

The capacity of UPS systems and the total equipment load the UPS is expected to support are usually quoted in VA. Where equipment load is quoted in Watts, multiply by 1.4 to get the VA load.

The calculation of how much UPS capacity is required depends on several choices.

- **What equipment to place on the UPS?**

Remember to include server PC's such as the voicemail and Feature Key Server PC's. It is recommended that the total load on a new UPS is never greater than 75% capacity, thus allowing for future equipment.

- **How many minutes of UPS support is required?**

Actual UPS runtime is variable, it depends on what percentage of the UPS's capacity the total equipment load represents. For example, a 1000VA capacity UPS may only support a 1000VA (100%) load for 5 minutes. This relationship is not linear, the same UPS would support a 500VA (50%) load for 16 minutes. Therefore the lower the percentage of capacity used, the increasingly longer the UPS runtime, typically up to 8 hours maximum. Remember also that for most UPS's the ratio of discharge to full recharge time is 1:10.

- **How many output sockets does the UPS provide?**

Multiple UPS units may be required to ensure that every item of supported equipment has its own supply socket.

The web site <http://ups.avayaups.com> provides a calculator into which you can enter the equipment you want supported on a UPS. It will then display various UPS options. The site uses VA values for typical IP Office systems. However, if more specific values are required for a particular system, the table below can be used to enter values.

Typical IP Office System	VA	Typical IP Office System	VA
Small Office Edition	17	IP412 System	312
IP406 V2 System	168	IP500 System	230
Individual Equipment	VA	Individual Equipment	VA
Small Office Edition	17	So8 Module	34
IP406 V2 Control Unit	23	Phone 8 Module	17
IP412 Control Unit	25	Phone 16 Module	23
Analog 16 Module	88	Phone 30 Module	42
Digital Station 16 Module	34	Typical Server PC	600
Digital Station 30 Module	42	Typical Desktop PC	400
WAN3 Module	17	Mid Span PSU - 6 ports	150
		Mid Span PSU - 12/24 ports	300

- The 1151D2 power supply unit for Avaya H.323 IP phones includes a backup battery. This typically provides 15 minutes backup at maximum load (20 Watts) and up to 8 hours at light load (2 Watts).

2.15 Cabling and Cables

The IP Office systems are designed primarily for use within an RJ45 structured cabling system using CAT3 unshielded twisted-pair (UTP) cabling and RJ45 sockets.

A structured cabling system is one where cables are run from a central RJ45 patch panel in the communications/data room to individual RJ45 sockets at user's desk. All wires in each cable between the patch panel and the desk socket are connected straight through. This arrangement allows devices connected at the patch panel to be swapped to match the type of device that needs to be connected at the user socket. For example, making one user socket a phone port and another user socket a computer LAN port, without requiring any rewiring of the cables in between.

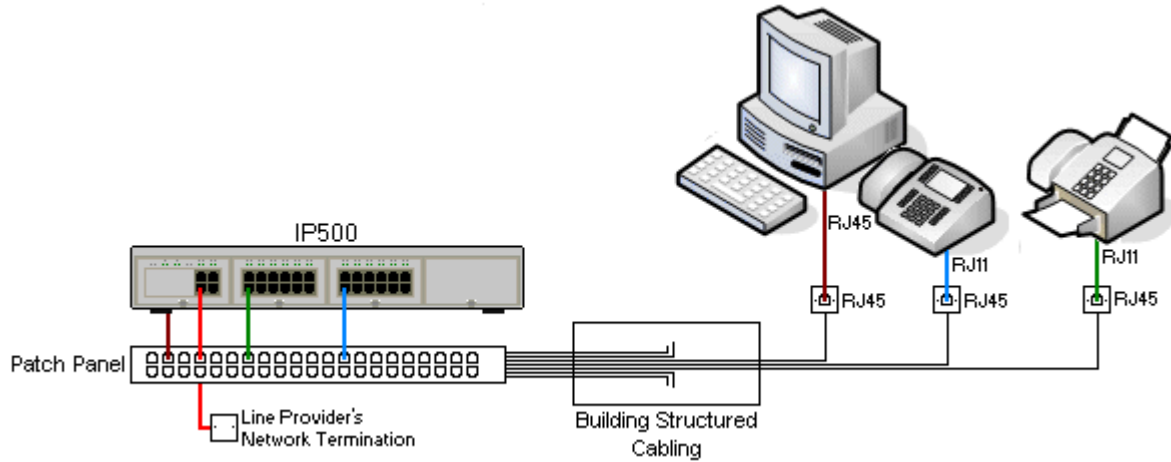

- **Traditional IDC Punchdown Wiring Installations**

Where necessary, the far end RJ45 plug can be stripped from IP Office cables and wired into traditional wiring systems using punch-block connectors. This type of installation should be performed by an experienced wiring technician.

- **Trunk Connections**

The majority of IP Office trunk ports use RJ45 connectors for acceptance of an RJ45-to-RJ45 cable. However, connection at the line providers end may require use of a different plug type in order to match the line providers equipment.

- **RJ11 Phone Connectors**

Many phones use RJ11 sockets and are supplied with RJ11-to-RJ11 cables. RJ11 plugs can be inserted into RJ45 sockets and in many case the connection will work. However this is not recommended or supported as the connection lock is not truly positive and may become disconnected. An [RJ45-to-RJ11 cable](#) is available for these connections.

Standard IP Office Cables

The following are Avaya standard cables available for use with IP Office systems. The maximum length is applicable if the standard Avaya cable is replaced with an alternate cable.

Cable	Description	SAP Code	Standard Length	Maximum Length
9-Way DTE Cable	Connects to control unit RS232 DTE port. 9-Way D-type plug to 9-way D-type socket.	-	2m/6'6"	2m/6'6"
Structured Cabling DS Line Cable	Connects from RJ45 sockets to RJ11 socketed DS and analog phones.	700047871	4m/13'2"	See table below.
BRI/PRI Trunk Cable	Connects BRI/PRI trunk ports to the line providers network termination point. RJ45 to RJ45. Red.	700213440	3m/9'10"	-
Expansion Interconnect Cable	Connects the control unit to expansion modules (except WAN3 modules). RJ45 to RJ45. Blue.	700213457	1m/3'3"	1m/3'3"
LAN Cable	Connects from IP Office LAN ports to IP devices. RJ45 to RJ45. Grey.	700213481	3m/9'10"	100m/328'
LAN Interconnect Cable	Connects WAN3 module to the control unit. Replace with a LAN crossover cable for IP412 control units. Green.	700213465	1m/3'3"	-
LAN Crossover Cable	Used for connection of IP devices to LAN ports on the IP412 control unit. Black	700213473	3m/9'10"	100m/328'
V.24 WAN Cable	37-Way D-type plug to 25-way D-type plug.	700213416	3m/9'10"	5m/16'5"
V.35 WAN Cable	37-Way D-type plug to 34-way MRAC plug.	700213424	3m/9'10"	5m/16'5"
X.21 WAN Cable	37-Way D-type plug to 15-way D-type plug.	700213408	3m/9'10"	5m/16'5"

The table below details the maximum total cable distances for DS and analog extensions using different cable types.

Telephone	Unshielded Twisted-Pair (UTP) - 50nf/Km			CW1308
	AWG22 (0.65mm)	AWG24 (0.5mm)	AWG26 (0.4mm)	
2400/5400 Series	1200m/3937'	1000m/3280'	670m/2200'	400m/1310'
4406D Phone	1000m/3280'	1000m/3280'	400m/1310'	400m/1310'
4412D Phone	1000m/3280'	700m/2295'	400m/1310'	400m/1310'
4424D	500m/1640'	500m/1640'	400m/1310'	400m/1310'
6400 Series	1000m/3280'	1000m/3280'	400m/1310'	400m/1310'
T3 Series (Upn)	1000m/3280'	1000m/3280'	400m/1310'	-
Analog Phones	1000m/3280'	1000m/ 3280'	400m/1640'	800m/2620'



2.16 Grounding

Use of ground connections reduces the likelihood of problems in most telephony and data systems. This is especially important in buildings where multiple items of equipment are interconnected using long cable runs, for example phone and data networks.

All IP Office control units and external expansion modules must be connected to a functional ground. In some cases, such as ground start trunks, in addition to being a protective measure this is a functional requirement for the equipment to operate. In other cases it may be a locale regulatory requirement and or a necessary protective step, for example areas of high lightning risk.

-  **WARNING**

During installation do not assume that ground points are correctly connected to ground. Test ground points before relying on them to ground connected equipment.

The ground point on IP Office control units and external expansion modules are marked with a  or  symbol. [Ground](#) connections to these points should use a 14 AWG solid wire with either a green sleeve for a functional ground or green and yellow sleeve for a protective ground.

- **Additional protective equipment**

In addition to grounding, additional protective equipment will be required in the following situations. Refer to "[Out of Building Telephone Installations](#)".

- On any Digital Station or Phones external expansion module connected to an extension located in another building.
- In the Republic of South Africa, on all Analog Trunk external expansion modules (ATM16) and on any control units containing an analog trunk cards (ATM4/ATM4U).

2.17 Lightning Protection/Out-of-Building Connections

The following are the only supported scenarios in which wired extensions and devices outside the main building can be connected to the IP Office system. In these scenarios, additional protection, in the form of protective grounding and surge protectors, must be fitted.

- ⚠ The fitting of additional protection does not remove the risk of damage. It merely reduces the chances of damage.

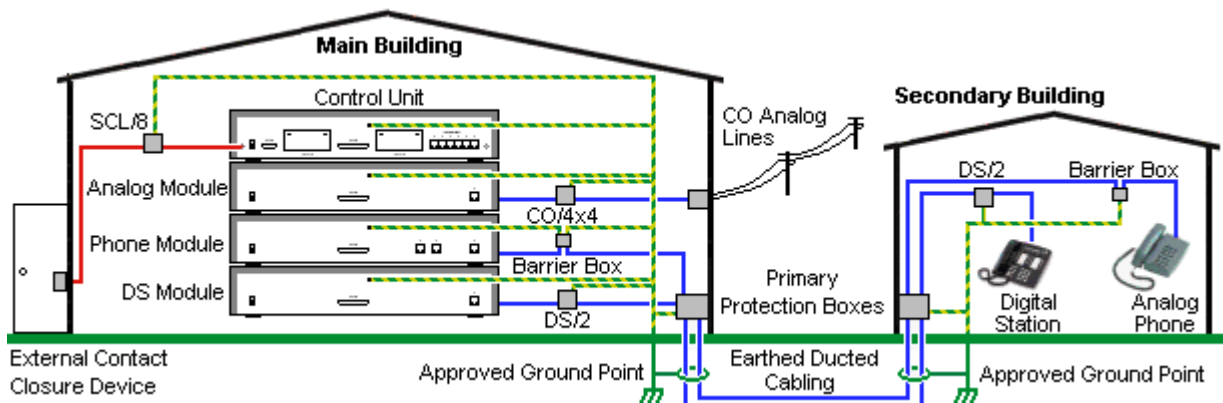

Cabling Requirements

- Cables of different types, for example trunk lines, extensions, ground and power connections, should be kept separate.
- All cabling between building should be enclosed in grounded ducting. Ideally this ducting should be buried.
- A Primary Protection Box must be provided at the point where the cables enter the building. This should be three point protection (tip, ring and ground). Typically this would be gas tube protection provided by the local telephone company. The ground wire must be thick enough to handle all the lines being affected by indirect strike at the same time.

Connection Type	Protection Device Type	Requirement
DS Phone Extensions ⚠ Digital Station Expansion module DS ports only.	ITWLinx towerMAX DS/2 Supports up to 4 connections. (This device was previously referred to as the Avaya 146E).	<ul style="list-style-type: none"> Connection from the expansion module to the phone must be via a surge protector at each end and via the primary protection point in each building. The IP Office expansion module and control unit and IROB devices must be connected to the protective ground point in their building.
Analog Phone Extensions ⚠ Phones Expansion module (POT or PHONE) ports only.	IP Office Barrier Box Supports a single connection. Maximum of 16 on any expansion module.	<ul style="list-style-type: none"> The between building connection must be via earthed ducting, preferable underground. The cable must not be exposed externally at any point.
Analog Trunks	ITWLinx towerMAX CO/4x4 Supports up to 4 two-wire lines. (This device was previously referred to as the Avaya 146C).	<p>For installations in the Republic of South Africa, the fitting of surge protection on analog trunks is a requirement.</p> <p>For other locations where the risk of lightning strikes is felt to be high, additional protection of incoming analog trunks is recommended.</p>
External Output Switch	ITWLinx towerMAX SCL/8 (This device was previously referred to as the Avaya 146G)	Connections from an IP Office Ext O/P port to an external relay device must be via a surge protector.

The towerMAX range of devices are supplied by ITWLinx (<http://www.itwlinx.com>).

2.18 Wall and Rack Mounting

All the IP Office control units are designed to be free-standing. On systems with external expansion modules, the control unit and modules are intended to be stacked.

Using additional option mounting kits, some systems can be wall or rack mounted.

	Wall Mount	Rack Mount
Small Office Edition	✓	✗
IP400 Control Unit	✗	✓
IP400 External Expansion Modules	✗	✓
IP500 Control Unit	✓	✓
IP500 External Expansion Modules	✗	✓

Wall Mounting

The Small Office Edition control unit can be wall mounted if required. The base of the unit includes mouldings suitable for this purpose and an additional securing bracket is supplied with the unit.

The IP500 control unit can also be wall mounted if not using an external expansion units. An IP500 wall mounting kit is required in addition to suitable wall fixings.

- **IP500 Wall Mounting Kit (SAP Code 700430150)**

This kit must be used when wall mounting an IP500 control unit. Additional 4.5mm fixings suitable for the wall type are required. A clearance of 500mm around the control unit is required.

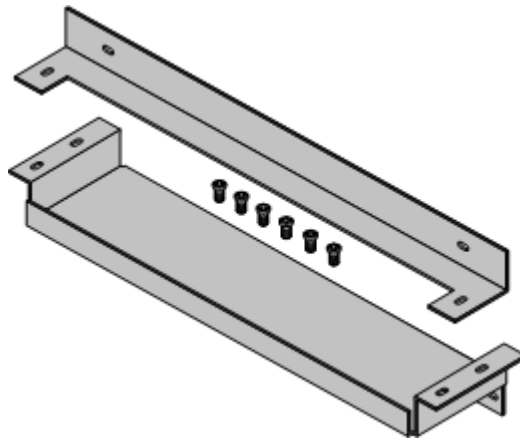

Rack Mounting

With the exception of the Small Office Edition, all IP Office control units and external expansion modules can be rack mounted into standard 19" rack systems. Each unit requires a 2U slot space within the rack. Rack mounting requires an IP400 or IP500 rack mounting kit for each control unit and external expansion module.

Where IP Office systems are being rack mounted, the effect of conditions with the rack cabinet must be considered. For example the rack temperature may be above the room temperature and airflow within the rack will be restricted. The [environmental requirements](#) for the individual IP Office units are still applicable.

- **IP500 Rack Mounting Kit (SAP 700429202)**

This kit contains all the components required for the rack mounting of a single IP500 control unit or IP500 external expansion module. This includes screws for fixing of the brackets to the module, bolts for securing the module in the rack and cable tidy brackets.

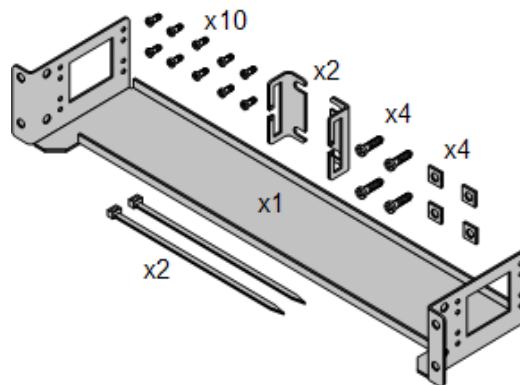

- **IP400 Rack Mounting Kit (SAP 700210800)**

This kit contains all the components required for the rack mounting of a single control unit or expansion module. This includes screws for fixing of the brackets to the module and bolts for securing the module in the rack.

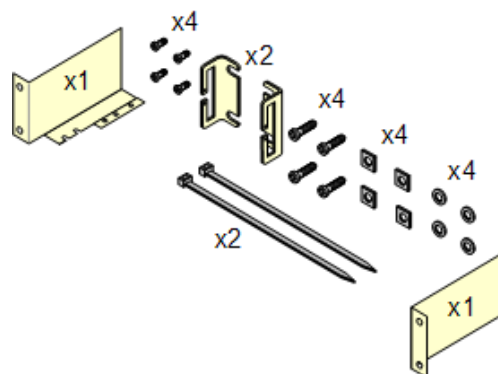

- **Barrier Box Rack Mounting Kit (SAP 700293905)**

Barrier boxes must be used for [out-of-building analog phone extensions](#). This bracket allows up to 8 IP Office barrier boxes to be rack mounted and simplifies the number of connections to the protective ground point in the rack. This kit must be used when more than 3 barrier boxes are in use and supports a maximum of 16 barrier boxes for a single external expansion module.

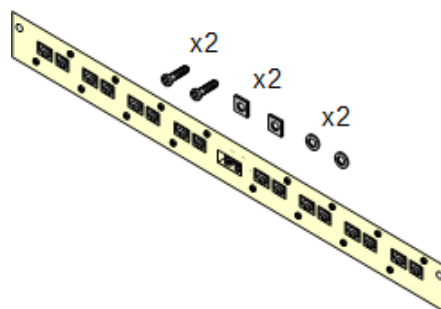

2.19 Feature Key Dongles

Various IP Office features and applications require entry of a [licence key](#) or keys into the system's configuration. Each licence key is a unique 32-character number based on the feature being activated and the serial number of a Feature Key dongle installed somewhere with the IP Office system.

- 



PC-Less Licensing
Uses a feature key dongle inserted or attached to the rear of the control unit. This method can be used with any of the IP Office control units supported by IP Office 4.0 and is mandatory with the IP500 control unit.



-

PC-Base Licensing
This method uses a dongle attached to a PC running the IP Office Feature Key server application. This PC must be on the same LAN segment as the IP Office control unit. Typically the dongle and IP Office Feature Key server application are installed on the same PC as the IP Office Voicemail Lite or Voicemail Pro application if present.

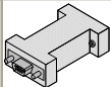
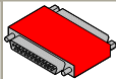
There are three type of Feature Key dongle available. The serial number is printed either directly onto the dongle or onto a label on the dongle.

Feature Key Type	Description	SOE	IP406 V2	IP412	IP500	SAP Code
Smart Card 	Inserts into a dedicated slot on the rear of the IP500 control unit. This card is required on IP500 systems even if not using any IP Office licenses.	✗	✗	✗	✓	MU-Law 700417470 A-Law 700417488
Serial 	Plugs directly into the DTE serial port on the rear of the control unit allowing PC-less operation.	✓	✓	✓	✗	700293095
Parallel 	Plugs into the appropriate port on a PC running the IP Office Feature Key server application. This PC must on the same LAN segment as the IP Office control unit.	✓	✓	✓	✗	700185234
USB 		✓	✓	✓	✗	700261506

2.20 License Keys

Various IP Office features and applications require entry of license keys into the system's configuration. The license keys are unique 32-character codes based on the feature being activated and the serial number of the IP Office system's [Feature Key dongle](#).

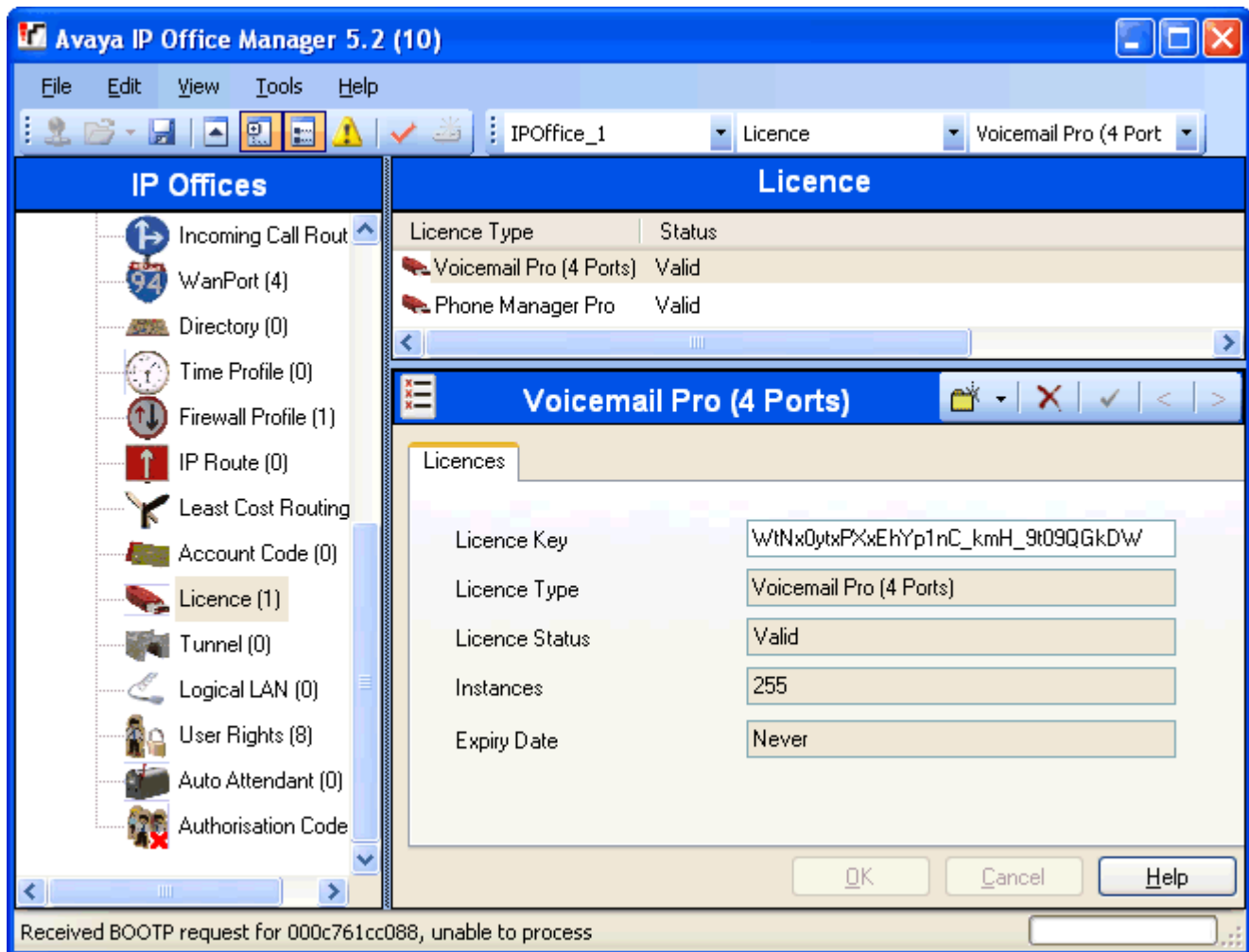

• Example 1: Enabling Software Features

In the example above, the IP Office system has a valid Phone Manager Pro license. In this case the license is for 20 instances. That means that up to 20 IP Office users can be configured to use Phone Manager Pro simultaneously. Their previously license free Phone Manager Lite software will automatically change to display Phone Manager Pro features.

• Example 2: Enabling Software and Features

The example above the IP Office also a license for Voicemail Pro. This initial Voicemail Pro license provide for 4 ports between the IP Office system and the Voicemail Pro PC. Additional Voicemail Pro (ports) licenses can be added to cumulative increase the number of port up to the limit supported by the particular type of IP Office control unit.

When a license key is entered into the IP Office configuration, the following information is shown.

• Status

The status, which is Unknown until the configuration file is sent back to the IP Office system.

• License

The name of the licensed feature. This may differ from the ordered RFA name.

• Instances

Depending on the license, this may be the number of ports enabled or number of simultaneous users of the licensed feature. Sometime the number of instances is specified in the license name.

• Expires

Most purchased licenses have no expiry setting. For some features, trial licenses may be available which will have an expiry date.

2.21 IP Office Phones

IP Office 4.2 supports the following phones and phone add-ons. Availability may be subject to local restrictions.

Digital stations connect to the IP Office via [DS](#) ports.

Series	IP Office Supported Digital Station (DS) Phones	Region
2400	2402 , 2410 , 2420 .	Global
4400	4406D , 4412D+ , 4424D+ . Not supported on the IP500 Digital Station card.	North America
5400	5402 , 5410 , 5420 .	Global
6400	6408D , 6416D+M , 6424D+M .	Global
T3 (Upn)	T3 Compact , T3 Classic , T3 Comfort .	Europe, Middle East and Africa
-	3810 Wireless phone .	North America

H323 IP Phones connect to the IP Office system via the RJ45 LAN or WAN.

Series	IP Office Supported H323 IP Phones	Region
1600	1603 , 1608 , 1616	Global
3600	3616 , 3620 , 3626 , 3641 , 3645 (Connect via AVPP add-on module).	
4600	4601 , 4602 , 4602SW , 4610 , 4610SW , 4620 , 4620SW , 4621SW , 4625 .	
5600	5601 , 5602 , 5602SW , 5610 , 5620 , 5621 .	
Softphone	Phone Manager Pro PC Softphone application (requires Phone Manager Pro and Phone Manager IP Audio licenses).	
T3 (IP)	T3 IP Compact , T3 IP Classic , T3 IP Comfort .	Europe, Middle East and Africa
Others	Other IP softphones and hardphones require entry of an IP Endpoints license. Functionality beyond making and answering calls is not guaranteed by Avaya.	-

Analog phones and devices connect to [PHONE](#) ports with the IP Office system. However due to the variety of analog phones and device available no guarantee of operation is given. It is the responsibility of the IP Office installer and maintainer to test and verify the operation of proposed analog equipment.

Series	IP Office Recommended Analog Phones	Region
6200 Series	6211, 6219, 6221.	North America
Interquartz Gemini	9330-AV, 9335-AV, 9281-AV.	Europe, Middle East, Africa, Asia-Pacific

Series	IP Office Supported DECT Phones	Region
IP DECT	3701 , 3711 - Connection via IP DECT base stations.	Global

2.22 Core Software & BIN Files

Each IP Office control unit and expansion module contains and runs its own part of the IP Office core software. These parts take the form of .bin files (binary files).

IP400 control units and external expansion modules are supplied with a base level of core software .bin files loaded. Currently this base level is IP Office 2.1. Therefore one of the first steps of the installation process is to upgrade the modules from this base level to the level of IP Office core software required.

IP500 control units are supplied with a base level of IP Office software that acts as a software loader for upgrading the unit to the required software level. This software loader supports the LAN connection necessary for local PC to IP Office upgrade.

The .bin files for each IP Office software level are included on the IP Office Administrator Applications CD for that software level. They are installed from that CD as part of the IP Office Manager application. IP Office Manager can then be used to upgrade the .bin files loaded in the modules within an IP Office system.

Updated sets of software and bin files may also be made available through the Avaya support web site. See [Web Sites](#).

- **Software Level**

The IP Office core software level is expressed in the form X.Y(Z), for example 2.1(27), where X is the major software level, Y is the minor level and Z is the build number.

The following rules apply to the core software level used by modules within an IP Office system and between linked IP Office systems.

- All modules within an IP Office should run the same level of core software. Doing otherwise will lead to incorrect operation of the system.
- By default the IP500 runs in a software mode called IP Office Express. To run in full IP Office mode requires the addition of various licenses.

Upgrading

Upgrading is performed using the Upgrade Wizard tool within the IP Office Manager application (File | Advanced | Upgrade). It displays the systems it can detect, their existing software level and the levels it has available.

- **Check IP Office Technical Bulletins**

Whenever upgrading check the latest IP Office Technical Bulletins for the various IP Office software releases involved before proceeding. These may contain information relating to changes that occurred after this document was completed. Bulletins are available from <http://support.avaya.com>.

- **Multi-Stage Upgrades**

As indicated in the table below, the upgrade path may require several intermediate upgrades. Skipping an intermediate level may lead to incorrect system operation and configuration corruption. Multi-stage upgrades are only necessary for control units. External expansion modules can be upgraded directly between any two levels supported by the module.

Control Unit	.bin File	Unvalidated Only	Validated
Small Office Edition	ip401ng.bin	2.0 > 2.1	2.1 > 3.0 > 3.1 > 3.2 > 3.2(999) > 4.2.
IP406 V2	ip406u.bin	–	2.1 > 3.0 > 3.0(999) > 3.1 > 3.1(999) > 3.2 > 4.2.
IP412	ip412.bin	1.3 > 2.1	2.1 > 3.0 > 3.1 > 3.2 > 4.2.
IP500	ip500.bin	–	4.0.0 > 4.2.

- **WAN3 10/100 Modules**

In systems containing these modules, it is recommended that control unit and any other external expansion modules are upgraded first before then upgrading the WAN3 10/100 module.

- **Large Systems**

In systems with a large number of external expansion modules, for example an IP412 with 12 external expansion modules, it may be necessary to upgrade the control unit first and then the modules.

There are three methods that the IP Office may use for upgrading, these are Validated, Offline and Unvalidated.

Validated Upgrade

This is the preferred method and can be used with any IP Office system that already has IP Office 2.1 or higher software. By default the Validate option within the Upgrade Wizard is pre-selected. During this process, the required BIN files are first transferred to the IP Office's RAM memory. Only when the files are received will the IP Office overwrite the existing software in its Flash memory and restart using the new files.

Offline Upgrade

On some systems, it may not be possible for the validated upgrade to download all the BIN files required into the IP Office system's RAM memory. If this is the case, the IP Office will offer to reboot in Offline mode and then attempt to continue the validated upgrade. In offline mode the IP Office only supports the service necessary to allow upgrading, for example it does not support Small Community Networking (SCN). If in offline mode for more than 15 minutes without being upgraded, the IP Office will reboot again back to normal operation.

Unvalidated Upgrade

This is the least preferred upgrade method. It should only be used from a PC directly connected to the IP Office and with a fixed IP address on the same LAN domain as the IP Office LAN1. This method involves erasing the existing software in the IP Office's Flash memory and then copying the new BIN files directly to the Flash memory. Its uses BOOTP and TFTP and requires a BOOTP entry for the IP Office system to exist on the Manager PC. This method should not be used unless absolutely necessary.

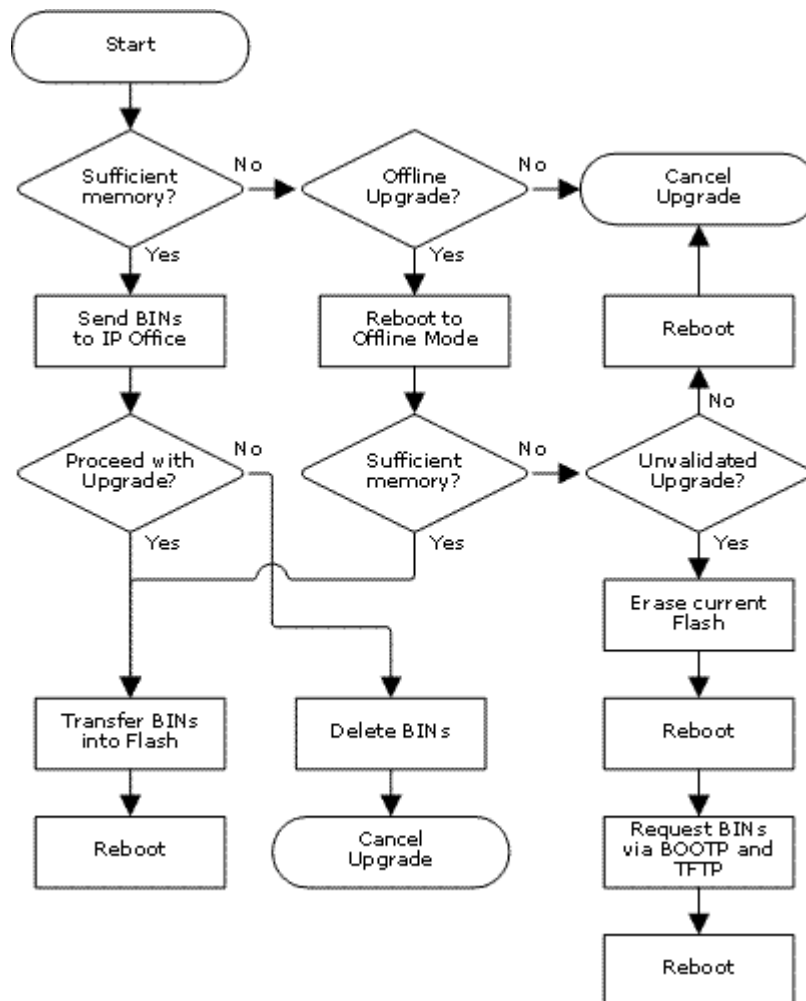

2.23 Supported Country Locales

When a new or defaulted system's configuration is first opened in Manager, the value set in the Locale field (System | System | Locale) should always be checked and changed if necessary. The system's Locale sets factors such as the default ringing patterns and caller display settings. The locale also controls the language that a voicemail server will use for prompts.

This following table indicates locale settings supported for different functions. Note that this does not necessarily indicate support, availability or approval for IP Office within that country.

This following table indicates locale settings used within 4.0 and higher for different functions. Note that reference to a locale does not necessarily indicate support, availability or approval for IP Office within that country.

TLA	Locale	Language	Telephony	Phone Display	Applications				Voicemail		
					Manager	Phone Manager	Soft Console	Conf' Center	EVM	Lite	Pro
ess	Argentina	Latin Spanish	✓	✓	✓	✓	✓	✓	✓	✓	✓
ena	Australia	UK English	✓	✓	✓	✓	✓	✓	✓	✓	✓
nlb	Belgium	Dutch	✓	✓	✓	✓	✓	✗	✓	✓	✓
frb	Belgium	French	✓	✓	✓	✓	✓	✓	✓	✓	✓
ptb	Brazil	Brazilian	✓	✓	✓	✓	✓	✗	✓	✓	✓
frc	Canada	Canadian French	✓	✓	✗	✗	✗	✗	✓	✓	✓
esl	Chile	Latin Spanish	✓	✓	✓	✓	✓	✓	✓	✓	✓
chs	China	Mandarin	✓	✗	✗	✓	✓	✗	✓	✓	✓
eso	Colombia	Latin Spanish	✓	✓	✓	✓	✓	✓	✓	✓	✓
dan	Denmark	Danish	✓	✓	✗	✓	✓	✗	✓	✓	✓
fin	Finland	Suomi	✓	✓	✗	✓	✓	✓	✓	✓	✓
fra	France	French	✓	✓	✓	✓	✓	✓	✓	✓	✓
deu	Germany	German	✓	✓	✓	✓	✓	✓	✓	✓	✓
ell	Greece	Greek	✓	✗	✗	✗	✗	✗	✗	✓	✓
zhh	Hong Kong	Cantonese	✓	✗	✗	✗	✗	✗	✗	✗	✓
hun	Hungary	Hungarian	✗	✗	✗	✗	✗	✗	✗	✓	✓
isl	Iceland	Icelandic	✓	✗	✗	✗	✗	✗	✗	✗	✗
ind	India	UK English	✓	✗	✓	✓	✓	✓	✗	✓	✓
ita	Italy	Italian	✓	✓	✓	✓	✓	✓	✓	✓	✓
kor	Korea	Korean	✓	✗	✗	✓	✓	✗	✓	✓	✓
esm	Mexico	Latin Spanish	✓	✓	✓	✓	✓	✓	✓	✓	✓
nld	Netherlands	Dutch	✓	✓	✓	✓	✓	✗	✓	✓	✓
enz	New Zealand	UK English	✓	✓	✓	✓	✓	✓	✓	✓	✗
nor	Norway	Norwegian	✓	✓	✗	✓	✓	✗	✓	✓	✓
esr	Peru	Latin Spanish	✓	✓	✓	✓	✓	✓	✓	✓	✓
plk	Poland	Polish	✓	✗	✗	✗	✗	✗	✗	✓	✓
ptg	Portugal	Portuguese	✓	✓	✗	✓	✗	✗	✓	✓	✓
rus	Russia	Russian	✓	✗	✗	✓	✓	✗	✓	✓	✓
ara	Saudi Arabia	UK English	✓	✗	✓	✓	✓	✓	✗	✗	✗
ens	South Africa	UK English	✓	✓	✓	✓	✓	✓	✓	✓	✗
esp	Spain	Spanish	✓	✓	✓	✓	✓	✗	✓	✓	✓
sve	Sweden	Svenska	✓	✓	✗	✓	✓	✓	✓	✓	✓
frs	Switzerland	French	✓	✓	✗	✗	✗	✗	✓	✓	✓
cht	Taiwan	Putonghua	✓	✗	✗	✓	✓	✗	✗	✗	✓
trk	Turkey	US English	✓	✓	✓	✓	✓	✓	✗	✗	✗
eng	UK	UK English	✓	✓	✓	✓	✓	✓	✓	✓	✓
enu	USA	US English	✓	✓	✓	✓	✓	✓	✓	✓	✓
esv	Venezuela	Latin Spanish	✓	✓	✓	✓	✓	✓	✓	✓	✓

- **TLA:**

These are the three character codes used by pre-3.2 IP Office systems to set locales. In IP Office 3.2 they have been replaced by selection of the required country or language by name. The special locale TTY may appear for some users. This is used in conjunction with Voicemail Pro and TTY devices for hearing impaired users. Refer to the Voicemail Pro Installation manual for full details.

- **Locale:**

The country represented by the locale.

- **Language:**

The voicemail prompt language used for that locale.

- **Manager:**

Indicates that the IP Office Manager application can run in the specific locale language. Manager uses the best match it has (French, German, Brazilian, Dutch, Italian, Mexican Spanish or US English) for the regional location settings setting of the PC on which it is running, otherwise it defaults to UK English. If required the language used within the Manager screens can be overridden.

- **Telephony:**

The IP Office provides default telephony settings matching the normal expected defaults for the locale.

- **Phone Display:**

Indicates that display messages from the IP Office to Avaya [DS](#) and IP phones can be sent using the appropriate language for that locale. Note that the user locale can be used to override the system locale for these messages. Note also that some phones support their own language selection options for menus displayed by the phone's software.

- **Voicemail:**

These columns indicate for which locales the different Avaya IP Office voicemail servers can provide the appropriate language prompts. In all cases, the system locale can be overridden by setting a different user locale.

- **EVM:**

Indicates that the locale is recognized by Embedded Voicemail and appropriate language prompts are then used. If an unsupported locale is used, Embedded Voicemail will attempt the best match using the first two characters of the locale.

- **VM Lite:**

Indicates that the locale is recognized by Voicemail Lite and appropriate language prompts are then used. For an unsupported locale is used, or one for which the necessary prompts are not available, Voicemail Lite will attempt the best match using a sequence of alternate locales.

- **VM Pro:**

Indicates that the locale is recognized by Voicemail Pro and appropriate language prompts are then used. For an unsupported locale is used, or one for which the necessary prompts are not available, Voicemail Lite will attempt the best match using a sequence of alternate locales. For example French Canadian (frc) fallback to French (fra), then US English (enu) and finally UK English (eng). Note that the languages available are selectable during Voicemail Pro installation. For further details refer to the Voicemail Pro manual.

2.24 Programming Applications

The following Windows applications are used to program and maintain an IP Office system. They run on PC's connected to the IP Office system via its LAN interface. These applications are all provided on the IP Office Administrator Applications CD and don't require any licenses.

Typically, with the exception of SNMP, all these applications would be installed onto a single PC on the customer's LAN in order to ensure that each is available on site if required. Due to the nature of the applications, this should be a secure PC. If a voicemail server PC is also being installed, the same PC can be used for the programming and maintenance applications.

For maintainers most of these applications can also be run remotely if a route for data connections to the customer IP Office exists from the maintainers location.

- **[IP Office Manager](#)**
This tool is used to access all parts of the IP Office configuration. Different levels of access can be defined to control which parts of the configuration the Manager user can view and alter. Manager is also used to upgrade the software files used by an IP Office system. When running it can also act as the TFTP server from which upgradeable Avaya phones can request new software.
- **[System Status Application](#)**
This application can be used to inspect the current status of IP Office lines and extensions and to view records of recent alarms and events. It runs as a Java application.
- **[Feature Key Server](#)**
This application is required for IP Office systems where licenses are being validated against a parallel or USB port Feature Key dongle. It must be installed on the same PC as the dongle.
- **[SNMP MIB's](#)**
Not an application as such. Using IP Office SNMP MIB files the status of the IP Office system to be monitored by 3rd-party SNMP applications such as Castlerock and HP OpenView. When configured for SNMP operation, the IP Office can also send alerts for potential problems. IP Office 3.2 and higher supports the sending of the same alerts used for SNMP to SMTP email addresses.
- **[Monitor \(SysMon\)](#)**
Monitor is a tool that can show a trace of all activity on the IP Office system in detail. As a consequence, interpretation of Monitor traces requires a high-level of data and telephony protocol knowledge. Despite that however, all IP Office installers and maintainers need to understand how to run Monitor when necessary as Avaya may request copies of Monitor traces to resolve support issues.
- **[Call Status](#)**
This application is used to display current calls in progress. Call Status is not supported on IP Office 4.0 but is still included in the IP Office Admin applications suite for maintainers who are supported IP Office's with earlier software levels.

2.25 User Applications

Through its LAN interfaces, the IP Office is able to let users run a number of Windows applications that operate in parallel with their telephones.

These applications are installed from the IP Office User Applications CD. Some of them require licenses to be entered into the IP Office system's configuration to enable features or to set the number of simultaneous users.

- **[Phone Manager](#)**
Phone Manager allows a user to control and monitor their phone through their PC. For Avaya phones that support handsfree operation, Phone Manager can be used to make and answer calls. During use, Phone Manager records details of calls made, answered and missed. It can also be configured to show the status of other users on the system. Phone Manager also allows the user to access and change many of the settings stored in the IP Office configuration that relate to their own phone operation, for example their forwarding destination numbers. Phone Manager software can operate in several modes:
- **[Phone Manager Lite](#)**
The default mode of Phone Manager. Requires no license, this application can be installed for any IP Office user.
- **[Phone Manager Pro](#)**
Users configured for Professional Edition mode are able to access a range of additional features. Phone Manager Pro requires entry of licenses into the IP Office system. The licenses also control the number of simultaneous Phone Manager Pro users. The user's Phone Manager software then automatically changes from Lite mode to Professional Edition mode.
- **[Phone Manager Pro PC Softphone](#)**
This is a PC softphone mode of Phone Manager operation. The user acts as a VoIP extension, making calls through the speaker and microphone of their PC. This mode requires further licenses in addition to the Phone Manager Pro licenses.
- **[TAPILink Lite](#)**
The Microsoft Telephony Application Program Interface (TAPI) allows TAPI compliant applications to interact with IP Office phones by installing an IP Office TAPI driver. TAPILink Lite does not require any licenses entered into the IP Office system's configuration. It allows TAPI compliant applications such as Outlook to make and answer calls. The speech part of the calls is still via the user's physical phone.
- **[SoftConsole](#)**
This is a licensed application. It is intended for telephone system operators or receptionists. It displays details of calls directed to the user and allows them to quickly see the status of the callers required destination and transfer the call. The SoftConsole user is able to access a range of details about the status of users and groups on the IP Office system. Up to 4 simultaneous SoftConsole users can be licensed.
- **[Conference Center](#)**
This is a server application that is then accessed via web browser. It also uses with a conference center password to book conferences. Details of the conference invitees can be entered and those people set to receive either an email or, using IP Office Voicemail Pro, a call asking them to join the conference.
- **[IP Office MS-CRM](#)**
Microsoft's MS-CRM is an application that allows the customer to maintain a database of their business contacts and details of interactions with those contacts. The IP Office MS-CRM component consists of three parts, one installed on the MS-CRM user PC, one installed on the customer's MS-CRM server and a license entered into the IP Office system's configuration. It allows the MS-CRM user to make and answer calls through their MS-CRM application.

2.26 Voicemail Applications

The IP Office supports a range of applications for the recording and playing of voicemail messages.

- **[Embedded Voicemail](#)**

Also called Integral Voicemail, this application is supported on Small Office Edition, IP406 V2 and IP500 control units. It is unlicensed but requires the addition of an Avaya memory card to store messages and prompts. Embedded Voicemail supports basic voicemail mailbox operation, simple auto-attendants and hunt group announcements.

- **[Voicemail Lite](#)**

This application does not require an IP Office license. It can be installed from the IP Office Administrator Applications CD to a Windows PC on the IP Office LAN. It provides voicemail operation for all IP Office users and groups, using the PC hard-disk to store prompts and messages. Only 4 simultaneous connections to leave or play messages are supported. Voicemail Lite is not supported on IP500 control units running in IP Office Express Edition mode.

- **[Voicemail Pro](#)**

This application requires various licenses entered into the IP Office configuration to control the features it offers and the number of simultaneous connections, up to 30 on the IP412 control unit. The operation of Voicemail Pro can be customized to provide special services. Voicemail Pro is not supported on IP500 control units running in IP Office Standard Edition mode.

- **Campaigns**

The Voicemail Pro can be configured to run a campaign. This consists of a series of questions for which the Voicemail Pro records the callers answer or key presses. The resulting recordings can then be played back by users. The web aspect of campaigns allows user to perform this playback and processing of campaign recordings via their web browser. This requires a web server to be run on the same PC as the Voicemail Pro software.

- **Text to Speech (TTS)**

Through adding additional licenses, the Voicemail Pro is able to use the TTS functions of Windows to speak text and numbers to callers in addition to recording prompts. This is intended mainly for scenarios where the Voicemail Pro is obtaining text and number values from a customer database.

- **Integrated Messaging Service (IMS)**

Both Voicemail Pro and Voicemail Lite support a feature called voicemail email to send messages or message alerts to a users email. This however is a one-way process. IMS allows this to become a two-way process, where users can play voicemail messages through their email mailbox or voicemail mailbox. IMS interoperates with the customer's Exchange server and the user's Outlook.

- **Database Integration**

With an additional license, the Voicemail Pro can be integrated with customer database through Windows ODBC. When combined with TTS operation, this allows the construction of interactive voice response (IVR) applications on Voicemail Pro.

- **[ContactStore for IP Office](#)**

Voicemail Pro can be used for manual and automatic call recording. Those recordings are placed into a mailbox and treated as normal messages. Contact Store allows those recordings to be redirected into a database on the ContactStore PC. This allows recordings to be archived and searched separately from mailbox messages. This application requires entry of a license into the IP Office configuration.

2.27 Call Logging Applications

A wide range of 3rd -party applications exist to provide call logging and accounting for telephone systems. The IP Office has a number of options for providing call details to those applications.

- **Call Detail Records (CDR)**

IP Office 3.1 and higher supports the sending of CDR records via TCP or UDP to an IP address. A range of common CDR record formats are supported. This option is configured within the IP Office itself.

- **Delta Server SMDR Output**

This application receives call information from the IP Office systems which it then shares with other applications. The Delta Server does not require a license in the IP Office configuration. Only one Delta Server can be used with each IP Office system. The Delta server can be configured to output a call log of all calls made and received by the IP Office system. The Delta sever send these records to an SMDR file stored on the PC and which can then be accessed by 3rd-party call logging applications. The Delta Server can also send SMDR records to a remote IP address.

2.28 Call Center Applications

- **Delta Server**

The applications below do not communicate directly with the IP Office system. They communicate across the LAN with a PC running the IP Office Delta Server application. This application receives call information from the IP Office systems which it then shares with other applications. The Delta Server does not require a license in the IP Office configuration. Only one Delta Server can be used with each IP Office system.

- **Compact Business Center (CBC)**

This is a licensed application. It receives data from the IP Office Delta Server application. The CBC is able to show details of calls handled by up to 3 selected hunt groups. Its can also display details of IP Office trunk usage. The CBC retains calls details for 31 days.

- **Compact Contact Center (CCC)**

CCC is a reporting application designed for use in call centers. It provides a range of both real-time and historical reporting options. CCC consists of a CCC Server application that receives call information from the IP Office Delta Server, and a number of client applications for the displaying of that information. CCC and its clients are controlled by a range of licenses entered into the IP Office configuration.

- The CCC server applications are listed below. They are installed onto the same PC:

- **CCC Archiver**

The Archiver manages the collection and storage of call activity information.

- **Wallboard Manager**

Wallboards provide current information on the number of calls waiting, response times and service levels. Wallboard Manager provides the ability to control both physical wallboards and PC wallboards.

- The CCC clients are:

- **Call Center View (CCV)**

Provides a realtime information about call center activity.

- **Alarm Reporter**

Provides real-time and past 7-days information on alarms that have occurred within the call center.

- **PC Wallboard**

The PC Wallboard allows call center agents and supervisors to display real-time call center performance information on their Windows PC screen.

- **Report Manager**

Provides in depth historical reporting on calls, agents and groups.

- **Workforce Management**

This application allows CCC to share information with a third-party agent scheduling application - Blue Pumpkin.

2.29 CTI Applications

- **TAPILink Pro**

Using the same software as TAPILink Lite, TAPILink Pro provides all of the features and functionality of TAPILink Lite, but additionally provides third party CTI operation. This means that a single server can control and monitor any number of telephone devices. This requires entry of a CTI Link Pro license. TAPILink Pro also provides the ability to monitor and control groups. This allows an application to be notified when a call enters a queue, and can also redirect it to another location. TAPILink Pro also supports additional TAPI functionality such as:

- Agent login.
- Agent logout.
- Set and retrieve divert destination.
- Set and retrieve extended divert status (Forward All Calls, Forward on Busy, Forward on No Answer, Do not Disturb).
- Retrieving the extension locale (language).
- Set and clear the message waiting lamp.
- Enable and disable group membership.
- Generate and detect DTMF digits and tones (requires the TAPI-WAV driver).

- **TAPI WAV driver**

Provides software-based support for voice processing. Purchasing the CTI Link Pro RFA license key also enables 4 ports of voice processing; additional ports can be purchased in 4 port increments. The TAPI-WAV driver is for use with TAPI 2.1 only; for TAPI 3.0, IP Office supports the Media Service Provider (MSP) interface, defined by Microsoft in TAPI 3.0.

- **DevLink Pro**

Provides a real-time event stream in addition to the SMDR interface provided in IP Office SMDR (see below). The real-time event stream takes the form of a call record, which is issued whenever the state of any endpoint of a call changes (typically there are two endpoints on a call, but for some circumstances, such as conference calls, intruded calls there may be more).

2.30 Application CD's/DVD's

The IP Office applications are available on a number of CD's and DVD's. These can be ordered at a nominal cost to cover order processing and delivery. Copies of the CD images can also be downloaded from the Avaya support website at <http://support.avaya.com>.

Those indicated with a ✓ are also available on a single IP Office 4.2 DVD (SAP 700459340).

Title	Discs	Description	SAP Code	DVD
IP Office 4.2 User and Administration CD Set	5	This CD set contains the IP Office Administrator Applications CD, IP Office User Applications CD and IP Office Documentation CD's (English, German and French). See below for details of the contents of each CD. <ul style="list-style-type: none"> • CD 1: Administrator Applications CD Contains: the IP Office Wizard, Monitor, Feature Key Server, Manager, Voicemail Lite, Call Status, DECT Integration applications plus SNMP MIB's. • CD 2: User Applications CD Contains the IP Office Phone Manager, TAPI, DevLink, MS-CRM Integration and SoftConsole applications. • CD 3/4/5: Documentation CDs Contains an HTML and PDF collection of IP Office documentation. Available in English, French and German versions. 	70045933 2	✓
Voicemail Pro 4.2 CD	2	This CD set is split into the first CD for Voicemail Pro and a second CD for the additional IP Office ContactStore application. <ul style="list-style-type: none"> • CD 1: Contains the Voicemail Pro application including components for Campaigns, IMS and VPNM. • CD 2: Contains the software for the IP Office ContactStore application. 	70045935 7	✓
Voicemail Pro ScanSoft TTS CD's	5	Contains various language text to speech engines for use with Voicemail Pro's TTS functions. Languages provided are Chinese, Dutch, English (UK), English (US), French, German, Italian, Japanese, Korean, Norwegian, Brazilian Portuguese, Russian, Spanish and Latin Spanish.	70029392 1	✗
Compact Contact Center V5.2 DVD	1	This DVD contains Delta Server, CBC and CCC.	70045154 5	✓
Conference Center V3.2 CD	1	Installs the IP Office Conference Center application.	70040759 6	✓

- It is acceptable to make copies of the Avaya IP Office CD's and DVD's listed above. However the content must remain intact, unaltered and without change or addition. Avaya does not accept any liability and responsibility for damage or problems arising from the use of such copies.

2.31 VoIP

The IP Office is a converged telephony system, that is it combines aspects of traditional PABX telephone systems and IP data network systems. This works at various levels.

- Individual phone users can control the operation of their phone through applications running on their PC.
- Data traffic can be routed from the LAN interface to a telephony trunk interface, for example a dial-up ISP connection.
- Voice traffic can be routed across internal and or external data links. This option is referred to as voice over IP (VoIP).

The VoIP mode of operation can include IP trunks between customer systems and or H.323 IP telephones for users. In either case the following factors must be considered:

- The IP Office control unit must be fitted with voice compression channels. These channels are used whenever a IP device (trunk or extension) needs to communicate with a non-IP device (trunk or extension). See [Voice Compression Channels](#).
- A network assessment is a mandatory requirement. For support issues with VoIP, Avaya may request access to the network assessment results and may refuse support if those are not available or satisfactory.

A network assessment would include a determination of the following:

- A network audit to review existing equipment and evaluate its capabilities, including its ability to meet both current and planned voice and data needs.
- A determination of network objectives, including the dominant traffic type, choice of technologies, and setting voice quality objectives.
- The assessment should leave you confident that the implemented network will have the capacity for the foreseen data and voice traffic, and can support H.323, DHCP, TFTP and jitter buffers in H.323 applications.
- An outline of the expected network assessment targets is:

Test	Minimum Assessment Target
Latency	Less than 150ms.
Packet Loss	Less than 2%.
Duration	Monitor statistics once every minute for a full week.

2.32 Voice Compression Channels

Calls to and from IP devices can require conversion to the audio codec format being used by the IP device. In the IP Office this conversion is done by voice compression channels. These support the common IP audio codecs G711, G723 and G729a.

For Small Office Edition control units either 3 or 16 integral channels are included. For IP400 control units channels can be added by fitting IP400 VCM cards. For the IP500 control unit channels can be added using either IP400 VCM cards or licensed IP500 VCM cards.

The voice compression channels are used as follows.

- **IP Device to Non-IP Device**
These calls require a voice compression channel for the duration of the call. If no channel is available busing indication is returned to the call.
- **IP Device to IP Device**
 - Call progress tones (for example dial tone, secondary dial tone, etc) do not require voice compression channels with the following exceptions:
 - Short code confirmation, ARS camp on and account code entry tones require a voice compression channel.
 - Devices using G723 require a voice compression channel for all tones except call waiting.
 - When a call is connected:
 - If the IP devices use the same audio codec no voice compression channel is used.
 - If the devices use differing audio codecs, a voice compression channel is required for each.
- **Non-IP Device to Non-IP Device**
No voice compression channels are required except for Small Office Edition Embedded Voicemail access.
- **Music on Hold**
This is provided from the IP Office's TDM bus and therefore requires a voice compression channel when played to an IP device.
- **Conference Resources and IP Devices**
Conferencing resources are managed by the conference chip which is on the IP Office's TDM bus. Therefore, a voice compression channel is required for each IP device involved in a conference. This includes services that use conference resources such as call listen, intrusion, call recording and silent monitoring.
- **Page Calls to IP Device**
Page calls require 1 voice compression channel per audio codec being used by any IP devices involved. IP Office 4.0 and higher only uses G729a for page calls, therefore only requiring one channel but also only supporting pages to G729a capable devices.
- **Voicemail Services and IP Devices**
Calls to the IP Office voicemail servers (Voice Mail Pro, Voicemail Lite and Embedded Voicemail) are treated as data calls from the TDM bus. Therefore calls from an IP device to voicemail require a voice compression channel.
 - On the Small Office Edition, embedded voicemail uses voice compression channels for audio conversion. Therefore all calls to SOE embedded voicemail require a voice compression channel and calls from IP devices require two voice compression channels.
- **Fax Calls**
These are voice calls but with a slightly wider frequency range than spoken voice calls. IP Office only supports fax across IP between IP Office systems with the Fax Transport option selected. It does not currently support T38.
- **SIP Calls**
 - **SIP Line Call to/from Non-IP Devices**
Voice compression channel required.
 - **Outgoing SIP Line Call from IP Device**
No voice compression channel required.
 - **Incoming SIP Line Call to IP Device**
Voice compression channel reserved until call connected.

Note: T3 IP devices must be configured to 20ms packet size for the above conditions to apply. If left configured for 10ms packet size, a voice compression channel is needed for all tones and for non-direct media calls.

2.33 Training

Avaya University provides a wide range of training courses for IP Office and its associated applications. This includes courses necessary for IP Office resellers to become Avaya Authorized Channel Partners and for individuals to achieve IP Office certification.

Details of all the course can be found on the Avaya University web site (<http://www.avaya-learning.com>). The site can be used to check course availability and to book course. It also includes on-line courses and on-line course assessments. The site requires users to setup a user name and password in order to track their personal training record.

The Avaya University site also includes details of the processes necessary for achieving different levels of product certification. These processes allow installers and maintainers to achieve certification in different areas such as Selling, Design, Implementation, Maintenance, Voicemail and Contact Centers. Levels of individual certification within those areas are:

- Avaya Certified Associate (ACA).
- Avaya Certified Specialists (ACS).
- Avaya Certified Expert (ACE).

Key IP Office courses are:

Course	Course Code
IP Office Hardware and Applications Overview	AVA00136WEN
IP Office Data Components	AVA00138WEN
IP Office Voicemail Pro	AVA00139WEN
IP Office Implementation Workshop	AVA00140H00
IP Office Advanced Applications Workshop	AVA00484H00
IP Office Telephones End-User Training	AVA00619WEN
IP Office Telephones End-User Training ILT	AVA00619H00
IP DECT (Europe only)	AVA00757WEN
IP Office Maintenance and Troubleshooting Workshop	AVA00758H00
IP Office Release 4.0 Product Delta	-

2.34 Web Sites

Information to support the IP Office can be found on a number of web sites.

- **Avaya** - <http://www.avaya.com>
The official web site for Avaya. The front page also provides access to individual Avaya web sites for different countries.
- **Avaya Enterprise Portal** - <http://partner.avaya.com>
This is the official web site for all Avaya Business Partners. The site requires registration for a user name and password. Once accessed, the site portal can be individually customized for what products and information types you wish to see and to be notified about by email.
- **Avaya Support** - <http://support.avaya.com>
Contains documentation and other support materials for Avaya products including IP Office. Copies of the IP Office CD images are available from this site and updated core software .bin files.
- **Avaya University** - <http://www.avaya-learning.com>
This site provides access to the full range of Avaya training courses. That includes both on-line courses, course assessments and access to details of classroom based courses. The site requires users to register in order to provide the user with access to details of their training record. See [Training](#).
- **Avaya Community** - <http://www.aucommunity.com>
This is the official discussion forum for Avaya product users. However it does not include any separate area for discussion of IP Office issues.
- **Avaya IP Office Knowledge Base** - <http://marketingtools.avaya.com/knowledgebase>
Access to an on-line regularly updated version of the IP Office Knowledge Base.
- **Avaya UPS Calculator** - <http://ups.avayaups.com>
An online calculator for uninterruptable power supply (UPS) requirements. Allows specification of a range of equipment to be supported including IP Office 403, 406 and 412 control units. See [Power Supply Backup \(UPS\)](#).
- **Other Non-Avaya Web Sites**
A number of third-party web forums exist that discuss IP Office. These can act as useful source of information about how the IP Office is used. Some of these forums require you to be a member and to register. These are not official Avaya forums and their content is not monitored or sanctioned by Avaya.
 - **Tek-Tips:** <http://www.tek-tips.com>.
 - **IP Office Info:** <http://www.ipofficeinfo.com>.
 - **Yahoo Groups:** <http://groups.yahoo.com/group/ipoffice>.
 - **Lycos Forum:** <http://members.lycos.co.uk/ipoffice>.
 - **PBX Tech:** <http://www.pbxtech.info/forumdisplay.php?f=8>.
 - **IP Office Italian:** <http://www.ipoffice.it>.
 - **IP Office UK:** <http://www.ipofficeforum.co.uk>.

Chapter 3.

Planning

3. Planning

3.1 Space Requirements

The Small Office Edition is designed to be free-standing or wall mounted. The base includes integral screw-head slots for wall mounting and an additional bracket is supplied with the module for a locking screw.

All the other IP Office control units and modules are designed to be installed either in a free-standing stack or into a 19" rack system. Rack installation requires a [rack mounting kit](#) for each control unit and expansion module.

- **Cable Clearance**

Clearance must be provided at the front and rear of all modules for cable access and feature key dangle connection.

- On IP400 and Small Office Edition systems, allow a minimum clearance of 75mm (3 inches).
- On IP500 systems allow a minimum clearance of 90mm (3.5 inches).

- **Additional Clearance**

Care should be taken to ensure that the positioning of the modules does not interrupt air flow and other factors that may affect [environmental requirements](#). This is especially important on IP500 control units which have ventilation slots at the side.

- **Cable Access**

Power cords must not be attached to the building surface or run through walls, ceilings, floors and similar openings. Installation measures must be taken to prevent physical damage to the power supply cord, including proper routing of the power supply cord and provision of a socket outlet near the fixed equipment or positioning of the equipment near a socket outlet.

Small Office Edition Control Unit

The Small Office Edition control unit can be used free-standing or wall mounted.

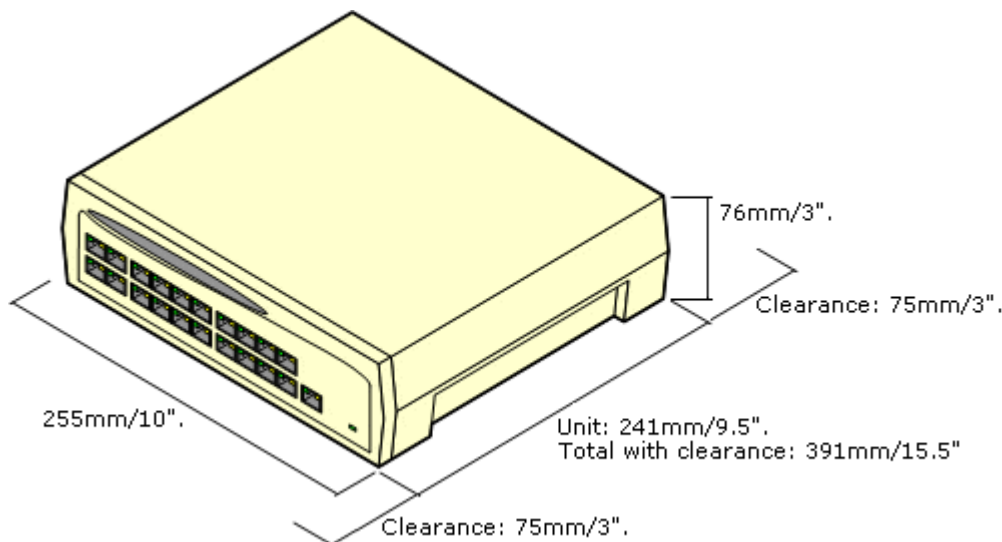

IP400 Control Units and External Expansion Modules

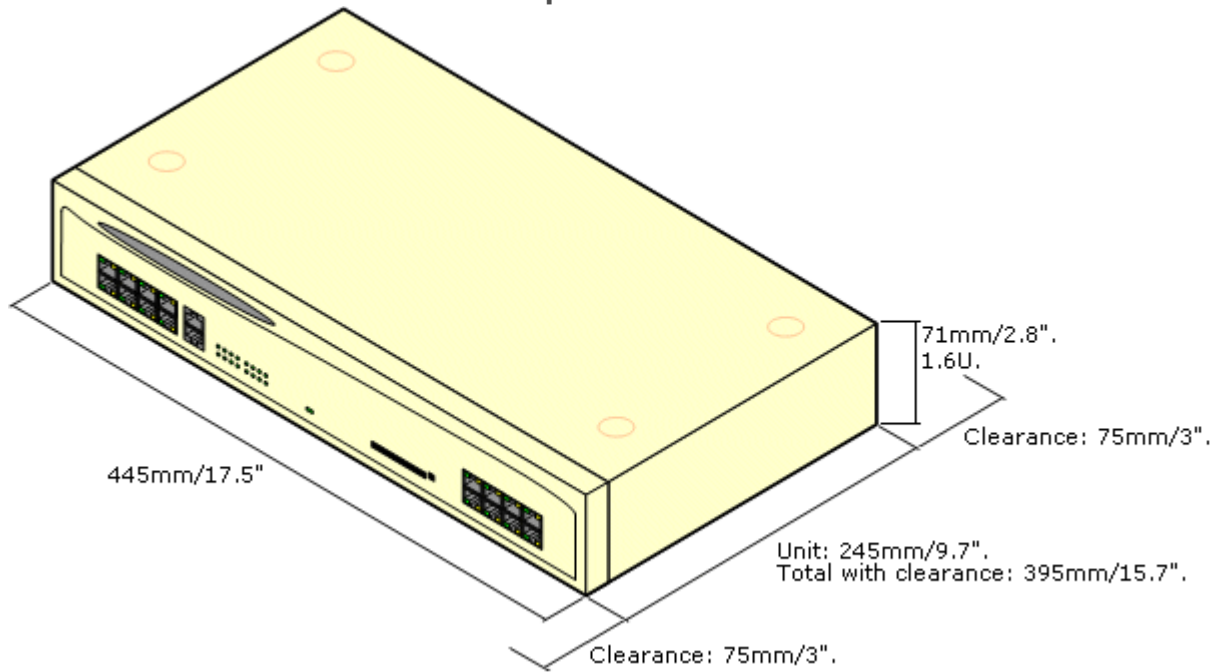

IP500 Control Unit

When wall mounted, a clearance of 500mm is required on all sides. The ventilation slots on the rear and sides should not be covered or blocked.

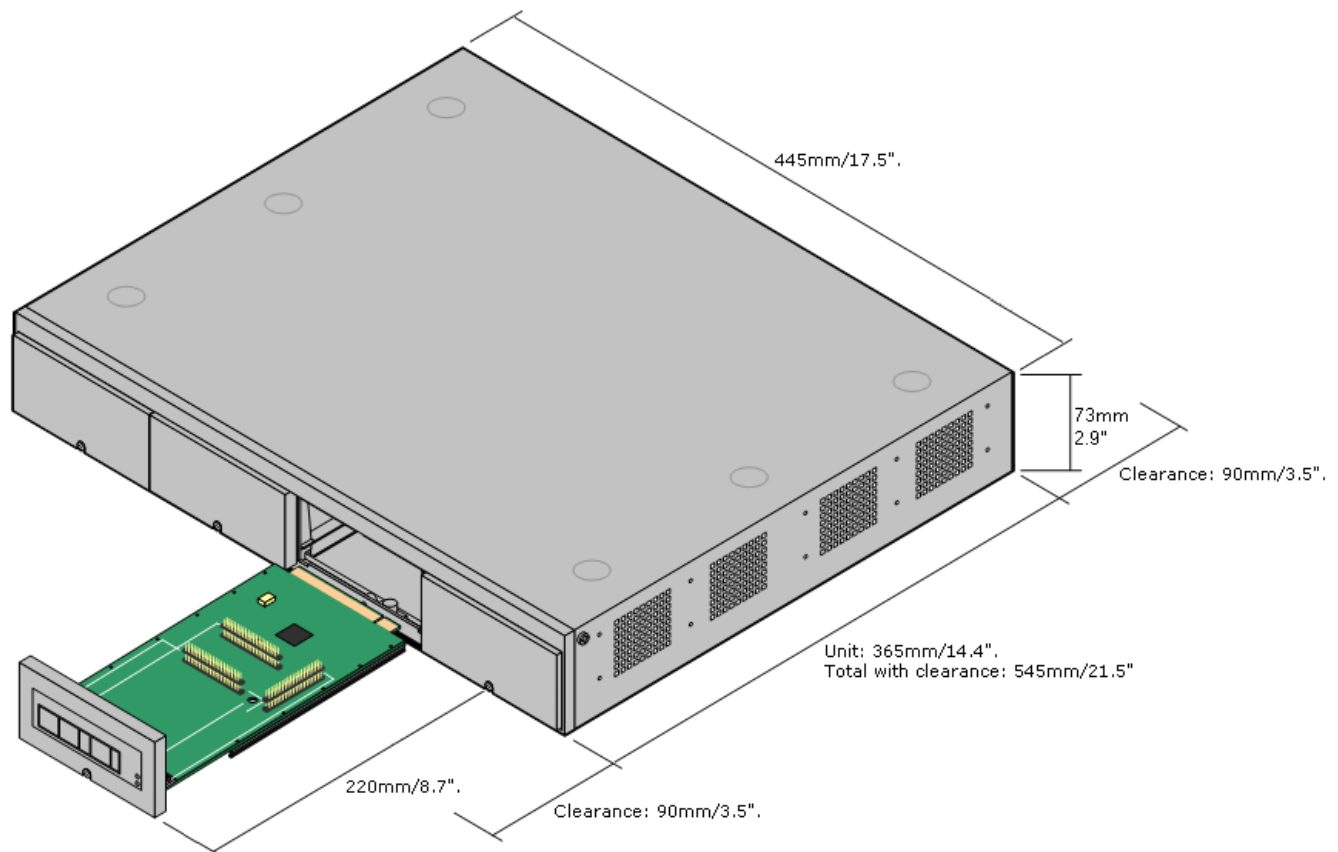

3.2 Environmental Requirements

The planned location must meet the following requirements. If being installed into a rack system, these are requirements for within the rack:

1. Temperature: 0°C to 40°C / 32°F to 104°F.
2. Humidity: 10% to 95% non-condensing.
3. Check there are no flammable materials in the area.
4. Check there is no possibility of flooding.
5. Check that no other machinery or equipment needs to be moved first.
6. Check that it is not an excessively dusty atmosphere.
7. Check that the area is unlikely to suffer rapid changes in temperature and humidity.
8. Check for the proximity of strong magnetic fields, sources of radio frequency and other electrical interference.
9. Check there are no corrosive chemicals or gasses.
10. Check there is no excessive vibration or potential of excessive vibration, especially of any mounting surface.
11. Check that where telephones are installed in another building, that the appropriate protectors and protective grounds are fitted (see [Out of Building Telephone Installation](#)).
12. Check there is suitable lighting for installation, system programming and future maintenance.
13. Check that there is sufficient working space for installation and future maintenance.
14. Ensure that likely activities near the system will not cause any problems, e.g. access to and maintenance of any other equipment in the area.
15. Where ventilation holes are present on any of the IP Office units, those holes should not be covered or blocked.
16. The surface must be flat horizontal for free-standing or rack mounted installations.

Wall Mounting

In addition to the requirements above, the following are applicable to IP Office units that support wall mounting.

1. Units must only be mounted onto permanent wall surfaces.
2. The surface must be vertical and flat.
3. Orientation of the unit must be as shown in the sections on [IP500 Wall Mounting](#) or [Small Office Edition Wall Mounting](#).
4. The appropriate Avaya wall mounting kits must be used.

IMPORTANT SAFETY INSTRUCTIONS

When using your telephone equipment, basic safety precautions should always be followed to reduce the risk of fire, electric shock and injury to persons, including the following:

1. Do not use this product near water, for example, near a bath tub, wash bowl, kitchen sink or laundry tub, in a wet basement or near a swimming pool.
2. Avoid using a telephone (other than a cordless type) during an electrical storm. There may be a remote risk of electric shock from lightning.
3. Do not use the telephone to report a gas leak in the vicinity of the leak.
4. Use only the power cord and batteries indicated in this manual. Do not dispose of batteries in a fire. They may explode. Check with local codes for possible special disposal instructions.

3.3 Tools and Parts Required

This section outlines the tools and miscellaneous parts likely to be required during the setup of an IP Office system. Other tools may also be required.



Tools Required

1. Pozidrive No. 1 screwdriver for removal of module covers.
2. Cutter for cable ties.
3. Pozidrive No. 4 screwdriver.
4. Wrist-strap for anti-static grounding or similar.
5. PC running Windows 2000/XP/2003.
During the Staging Installation later in this manual, we recommend that you use a customer PC that will eventually remain on site. Ideally this will be the same PC that will be used as the customers Feature Key server and or voicemail server.
6. Indelible marker for cable labelling.



Parts Required

1. Cable ties.
2. Cabling labels.
3. IP Office CD Pack
Contains IP Office Administration Applications CD, IP Office User Applications CD and IP Office Engineers Toolkit CD.
4. Technical Bulletins
Each IP Office software release is normally accompanied by a Technical Bulletin detailing special installation requirements, known issues, etc. Various software releases and their associated Technical Bulletins can also be obtained from <http://support.avaya.com>.



Chapter 4.

Pre-Configuration

4. Pre-Configuration

4.1 Off Line Configuration

Manager supports a number of methods by which the configuration of an IP Office system can be setup in advanced of the physical IP Office. This allows pre-configuration and speeds up the actual on-site installation.

It also allows potential configuration questions to be raised and resolved with the customer in advance of the on-site installation, reducing the number of post-installation changes required.

- **[Creating a New Configuration](#)**

Manager can be used to create a new configuration, specifying the locale, control unit type, expansion modules and trunk cards in the process. This then gives a default configuration onto which the customer requirements can be prepared.

- **[Importing Settings](#)**

Manager can import settings in the form a simple CSV files. It can also be used to export the settings from another IP Office system's configuration and then import those settings into a different configuration.

4.2 Creating a New Configuration

Manager can be used to create a new configuration without connecting to an IP Office system. During the process, you can specify the locale of the system, what type of trunk cards it uses and what type of control unit and expansion modules to include.

This allows the creation of a configuration prior to installation of the real system and so can be used to speed up installation.

- The configuration created must match the physical equipment in the IP Office system onto which the configuration will be loaded. Doing otherwise may cause the IP Office system to reset and experience other problems.
- The Create Configuration tool includes all control units, external expansion modules and trunk cards supported by IP Office. It is your responsibility to confirm what IP Office equipment is supported in your locale.

Creating a New Configuration

1. Click  in the main toolbar or select **File | Offline | Create New Config** from the menu bar.
2. Select the **Locale** for the system. This defines a range of features such as default telephony settings. Click **Next >**.
3. Select the type of IP Office control unit. Then select the expansion modules, excluding WAN3, to also include in the system. Click **Next >**.

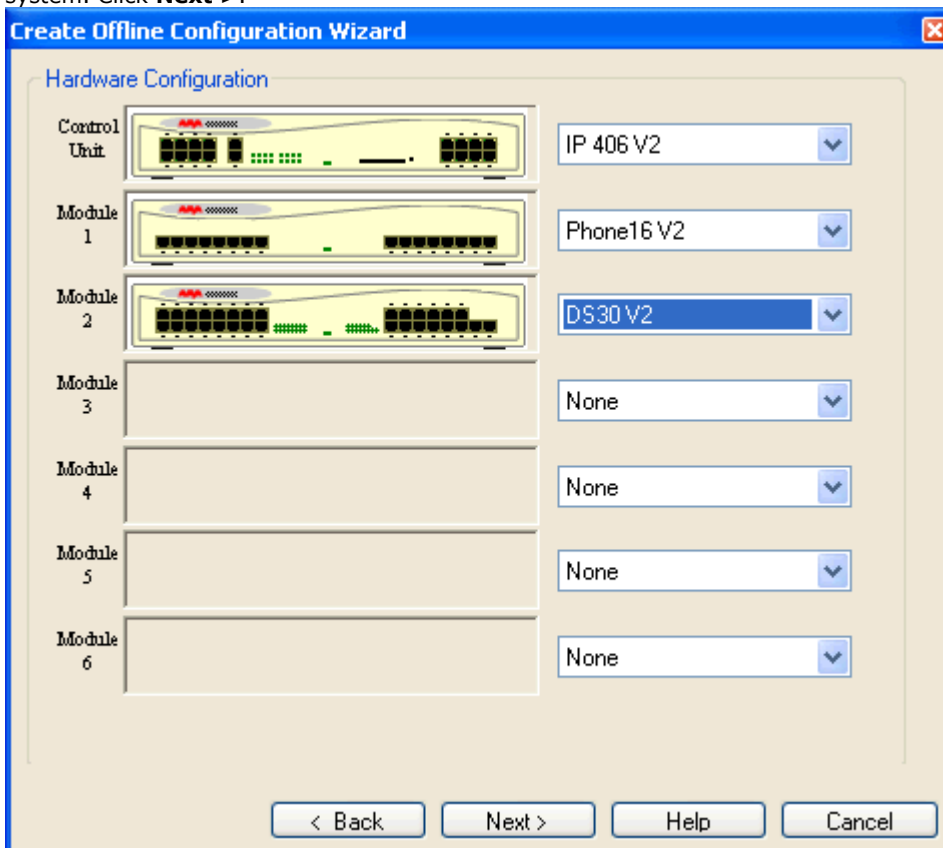

4. Select the trunks cards to be included and the IP address of a WAN3 module if required. Click **Finish**.
5. The configuration is created and loaded into Manager.
6. Once this configuration has been edited as required it can be saved on the PC. In order to send it to the matching IP Office system, **File | Offline | Send Configuration** has to be used.

4.3 Importing and Exporting Settings

Manager can import configuration settings created elsewhere. This can be useful when setting up a new system or sharing common settings such as a directory between systems.

Settings are imported and exported in two formats:

- **Binary Files (.exp)**

These are non-editable files. During import and export it is possible to select what types of entries should be included in the file. During import the whole file is imported.

- **Comma Separated Variable Text Files (.csv)**

These are plain text files. In addition to being exported from an IP Office system these files can be created and edited using programs such as WordPad or Excel.

- **UTF-8 Character Encoding**

Manager imports and exports CSV files using UTF-8 character encoding which uses a double byte to support characters with diacritic marks such as ä. Other applications, such as Excel, may, depending on the user PC settings, use different encoding which will cause such characters to be removed or corrupted. Care should be taken to ensure that any tool used to create or edit the CSV supports all the characters expected and uses UTF-8 format.

- **Importing into Manager from Excel**

From Excel save the file as a .csv. This file will use ANSI character encoding. Open the file in Notepad and use the **Save As** option to rename the file and select UTF-8 encoding. Import the UTF-8 version of the file into Manager.

- **Exporting from Manager into Excel**

Do not double-click on the file exported from Manager. Start Excel and use **File | Open** to select the file. Excel will recognize that the file uses UTF-8 encoding and will start its text file importation wizard. Follow the wizard instructions and select comma as the field delimiter.

Exporting Settings

1. Select **File | Import/Export...** from the menu bar.
2. Select **Export**.
3. Select the type of file. The list of exportable entry types will change to match the file type.
4. Select the types of items that should be exported.
5. Use the **Save In** path to select the location for the exported files. The default location used is sub-directory of the Manager application directory based on system name of the currently loaded IP Office system.
6. Click **OK**.

Importing Settings

Importing settings will overwrite any existing entries that match an entry being imported.

1. Select **File | Import/Export...** from the menu bar.
2. Select **Import**.
3. Select the type of file. The list of items will change to match the type of file selected and whether a matching file or files is found in the current file path.
4. Use **Look In** to adjust the file path. The default location used is sub-directory of the Manager application directory based on system name of the currently loaded IP Office system.
5. Select the types of items that should be imported.
6. Click **OK**.

CSV File Formats

The format is CSV using commas as field separator, no text delimiters and no header row. The simplest way to check the required format for a CSV file prior to import, is to export and study the settings from an existing system.

File Name	Fields in Order
Directory	Name, Number.
HuntGroup	Name, Extension, Group, Hunt, Rotary, Idle, Queuing On, Voicemail On, Broadcast, Voicemail Email.
License	License, License Key
ShortCode	Code, Telephone Number, Feature.
User	Name, Extension, User Restriction/Rights, Voicemail Email.
Configuration	Proprietary format

Notes

- **Hunt Group:** Apart from Name, Extension and Voicemail Email, the fields use a 1 or 0 value for on or off.
- **License:**
 - The License field is for information only and is ignored during import.
 - Following import the License name may appear as invalid with Manager. To resolve this save and then reload the configuration file.
- **System:** The format of the system CSV is too complex to be described. It is a full export of all the IP Office system's configuration settings. This file format should only be used for export and import between systems and not for any offline editing.

Chapter 5.

Small Office Edition

Installation

5. Small Office Edition Installation

5.1 Unpacking

Use the following procedure when unpacking any equipment supplied by Avaya or an Avaya distributor.

 **Objective** - To check that the correct equipment has been supplied and that no damage has occurred during transit.

 **Information Required**

1. **Equipment Checklist.**
Draw up an installation checklist of the parts and equipment expected.

 **Procedure**

1. **Check for Package Damage.**
Before unpacking any equipment, check for any signs of damage that may have occurred during transit. If any damage exists bring it to the attention of the carrier.
2. **Check the Correct Parts Have Been Delivered.**
Check all cartons against the packing slip and ensure that you have the correct items. Report any errors or omissions to the equipment supplier.
3. **Retain All Packaging and Documentation.**
While unpacking the equipment, retain all the packaging material. Fault returns are accepted only if repackaged in the original packaging. If performing a staged installation, the original packaging will also assist when repacking equipment to be moved to the final install site.
4. **Ensure that Anti-Static Protection Measures are Observed**
Ensure that anti-static protection measures are observed at all times when handling equipment with exposed electrical circuit boards.
5. **Check All Parts.**
Visually inspect each item and check that all the necessary documentation and accessory items have been included. Report any errors or omissions to the dealer who supplied the equipment.
6. **Check All Documentation.**
Ensure that you read and retain any documentation included with any items.

5.2 Installing the Admin Applications

This procedure covers installation of applications in the IP Office Admin suite.

 **Objective** - To install the applications necessary for the installation and maintenance of an IP Office system.

Information Required

1. Which IP Office Admin Suite applications are being installed?

The following list indicates those that are required for installation and configuration:

- **System Monitor - Install**
Monitor is a tool intended primarily for Avaya technicians and engineers. However it is able to report on all aspects of IP Office operation and is therefore an important tool for diagnostics.
- **Feature Key Server - Optional**
The Feature Key Server should only be installed if the PC will host the parallel port or USB port Feature Key dongle for the IP Office system.
- **Manager - Install**
This application is required to edit and manage the software on the IP Office system.
- **Voicemail Mail Lite - Optional**
Only install this application if no other voicemail such as Voicemail Pro or embedded voicemail is being installed. IP Office Lite is not supported by IP500 systems running in IP Office Standard Edition mode.
- **System Status Application - Install**
This application is used with IP Office 4.0 systems to show equipment and resource within the system, alarms and calls in progress.
- **Previous System Monitor - IP400 Install/IP500 Optional**
For IP400 control unit this version of monitor is required until the system is upgraded to IP Office 4.0 software.
- **Call Status - Optional**
This application is only supported for pre-4.0 IP Office systems. For IP Office 4.0 and higher it has been replaced by the System Status Application above.

Parts Required

1. IP Office Administrator Applications CD.

2. Windows PC

This should meet the requirements of the administrator applications being installed. If a server PC from the customer installation is available, for example for Voicemail Pro, use that PC. The specification below is just for IP Office Manager. If other applications are to be installed on the PC then their requirements should also be met.

Requirement	Minimum	Recommended
Processor	600MHz Pentium or AMD Opteron, AMD Athlon64, AMD Athlon XP.	800MHz Pentium or AMD Opteron, AMD Athlon64, AMD Athlon XP.
RAM	128MB	256MB
HD Space	1GB - 800MB for .NET2, 200MB for Manager.	1.4GB - 800MB for .NET2, 600MB for the full IP Office Admin suite.
Display	800 x 600 - 256 Colors	1024 x 768 - 16-bit High Color
Operating System	Windows XP Professional with SP2. Windows 2003 Server. Windows 2003 SBS. Note: 64-bit versions of the operating systems above are not supported.	

Procedure: Installing the IP Office Admin Applications

- Using the **Add or Remove Programs** option in the Windows Control Panel, check that the PC does not already have a version of the IP Office Admin suite installed.
 - If 'yes' and the suite is a pre-IP Office 3.2 version, remove the existing IP Office Admin suite via Add/Remove Programs.
 - If the existing suite is IP Office 3.2 or higher, it is possible to upgrade without removing the previous installation.
- Insert the IP Office Administrator Applications CD. The installation process should auto start. If it does not auto start, open the CD contents and double-click **setup.exe**.
- Select the language you want to use for the installation process. This does not affect the language used by Manager which will attempt to match your Windows regional setting. Click **Next >**.
- Select whether only the current Windows logon account should be able to run the Admin Suite applications or whether they will be available to all users of the PC. Click **Next >**.
 - The previous selection does not affect the IP Office Feature key server application, if installed. That application runs as a service whenever the PC is running.
- If required select the destination to which the applications should be installed. We recommend that you accept the default destination. Click **Next >**.
- The next screen is used to select which applications in the suite should be installed. Clicking on each will display a description of the application. Click on the ▼ next to each application to change the installation selection. When you have selected the installations required, click **Next >**.

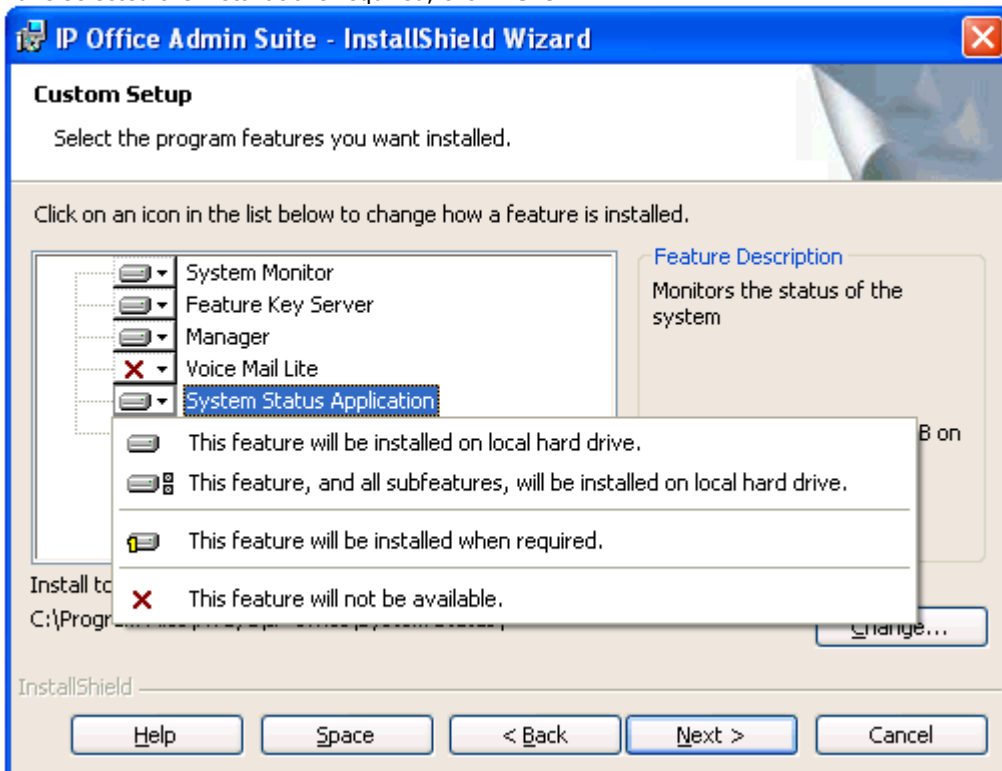

- For IP Office system installations, ensure that at minimum System Monitor and Manager are selected.
 - Only select Voice Mail Lite if this PC will also be the customer's Voicemail Lite server PC.
 - Deselect Feature Key Server unless this PC will be hosting a Parallel port or USB port Feature Key dongle for the customer's IP Office system.
- Click **Install**.
 - Installation of Windows .Net2 components may be required. If dialogs for this appear, follow the prompts to install .Net.
 - If requested, reboot the PC.

5.3 Default Control Unit Power Up

This procedure starts a new IP Office control unit not connected to any LAN. In this scenario the IP Office control unit will assume its default configuration settings.

 **Objective** - To power up the IP Office control unit to a known state with a known set of defaults.

Parts and Equipment Required

1. Switched power outlet socket.
2. IP Office Control Unit.
3. Locale Specific Power Cord.

Procedure

1. Remove the control unit from its box and check its condition.
2. Connect the external power supply unit to the control unit.
3. Connect the power cord from the power supply outlet to the external power supply unit.
 - Power cords must not be attached to the building surface or run through walls, ceilings, floors and similar openings. Installation measures must be taken to prevent physical damage to the power supply cord, including proper routing of the power supply cord and provision of a socket outlet near the fixed equipment or positioning of the equipment near a socket outlet.
4. Switch on power to the control unit.
5. Observe the center LED on the far-right of the front of the Small Office Edition control unit. Initially this LED will be red. After approximately 10 seconds it should change to green. During this time other LED's may flash as the unit goes through its power on self test cycle.

IP Office Default Settings

The following are the basic default configuration settings for an IP Office system.

System	Name	MAC address of the control unit.	
	System Password	password	
	License Server IP Address	255.255.255.255	
LAN*		LAN1	LAN2/WAN
	IP address	192.168.42.1.	192.168.43.1
	IP Mask	255.255.255.0	255.255.255.0
	DHCP Mode	Server	Server
	No of DHCP IP Addresses	200.	200.

*See **Default DHCP/Data Settings** detail below.

- **Extensions and Users**

A user is automatically created for each physical extension port detected in the system. Users are assigned extension numbers starting from 201. User names take the form Extn201, Extn202,

- **Hunt Group**

A single hunt group 200 called Main is created and the first 10 users are placed into that hunt group as members.

- **Incoming Call Routes**

Two default incoming call routes are created. Voice calls are routed to the hunt group Main. Data calls are routed to the RAS user DialIn.

- **Default Short Codes**

IP400 control units are manufactured as either A-Law or U-Law variants. For IP500 control units, A-Law or U-Law variant operation is determined by the IP500 Smart Card installed. Depending on the variant, different sets of short codes are created for the default configuration. Refer to the IP Office Manager application help for full details.

- **Default DHCP/Data Settings**

When a defaulted IP Office control unit is switched on, it requests IP address information from a DHCP Server on the network. This operation will occur whether the LAN cable is plugged in or not.

- If a DHCP server responds within approximately 10 seconds, the control unit defaults to being a DHCP client and uses the IP address information supplied by the DHCP server.

-
- If no DHCP Server responds, the control unit defaults to being the DHCP server for the LAN using the following settings:
 - For its LAN1 it allocates the IP address 192.168.42.1 and IP Mask 255.255.255.0. It supports 200 DHCP clients using the addresses range 192.168.42.2 and 192.168.42.201, the IP Mask 255.255.255.0 and default gateway address 192.168.42.1 (the Control Unit's LAN1 address).
 - For its LAN2 if supported, it allocates the IP address 192.168.43.1 and IP Mask 255.255.255.0.
 - Note that the IP Office does not check that these addresses are valid and or available on the network.
 - This mode of operation will persist for subsequent power ups, until a config save occurs due to one of the following
 - The unit performs its automatic midnight backup.
 - A configuration is merged using IP Office Manager.
 - A soft reboot is performed using IP Office Manager.
 - A software upgrade is performed.

5.4 Connecting the Manager PC

At this stage we will directly connect the Manager PC to the new IP Office control unit. For this the PC will need to be set to a fixed IP address in the same subnet range as the IP Office control unit's default address (192.168.42.1/255.255.255.255).

 **Objective** - Physically connecting the Manager PC and the IP Office without needing to adjust or configure any intervening equipment.



Parts and Equipment Required

1. **Manager PC.**
2. **LAN Cable.**
- **IP Office Small Office Edition, IP406 V2 and IP500 control units:**
A standard RJ45-RJ45 LAN cable can be used.
- **IP412 Control Unit:**
A RJ45-RJ45 cross-over LAN cable is required.



Procedure: Direct Connection to a Defaulted IP Office Control Unit

1. Check that the TCP/IP properties for the Manager PC's Local Area Network connection are set as follow:
 - **Fixed IP address:** 192.168.42.203
 - **Subnet mask:** 255.255.255.0
 - **Default gateway:** 192.168.42.1.
2. Connect the LAN cable from the PC's LAN port the LAN 1 port on the IP Office control unit.
3. Check that the orange LED lamp on the IP Office LAN port is on. The green LED may also be flickering as it indicates traffic across the LAN connection.
4. Select **Start | Run** and enter **cmd**.
5. In the command window that appears enter ping 192.168.42.1. The results should show a number of ping replies from the IP Office. This confirms basic communication between the Manager PC and the IP Office.
6. If there are no ping replies
 - Enter **ipconfig**. The results should list the IP address settings of the Manager PC as required above and with no mention of DHCP being used. Enter exit.
7. Check the cable connection.

5.5 Receiving a Configuration (Pre 3.2)

The following is the normal procedure for receiving a copy of the IP Office configuration from a new or defaulted control unit running pre-3.2 IP Office core software.

 **Objective** - This process tests the communication between the Manager application and the IP Office control unit.

 **Information Required**

1. **System Password** - For a new or defaulted system this is password.

1. 
2. 
3. 

Procedure: Receiving the Configuration from a Pre-3.2 IP Office Control Unit

1. Select **Start | Programs | IP Office | Manager**.

2. Click  in the main toolbar or select **File | Open Configuration** from the menu bar.

3. The Select IP Office window appears. After a few seconds it should list the control unit that is being setup. The default name used is the control units MAC address.

- If the system required was not found, the address used for the search can be changed. Enter or select the required address in the Unit/Broadcast Address field and then click Refresh to perform a new search.

4. Click the check the box next to the system and then click OK.

5. The name and password request is displayed. The name must match a Manager operator and the password must match the IP Office control unit's system password. For a defaulted IP Office with pre-3.2 IP Office software enter Administrator and password.

- The name and password used above are applicable to new control units which are supplied with a basic IP Office 2.1 level of software. Once upgraded to IP Office 3.2 the name and password required change.

6. Successful receiving of the configuration is shown by the full configuration tree being shown in the left-hand panel. With no configuration loaded the configuration tree shows just BOOTP and Operator.

5.6 Using Monitor

Monitor is a tool intended primarily for Avaya technicians and engineers. However it is also able to report the presence of hardware devices that are not reported by the IP Office Manager application and is therefore an important tool during the installation process. This process shows how System Monitor can be used to obtain information about the components installed with the IP Office control unit.



Objective

To introduce System Monitor so that it can be used during later stages of installation to confirm the correct installation of some components into the control unit.



Warnings

1. Running Monitor can create a high network load on the IP Office system. Therefore it should only be used when necessary and should be closed when not needed.



Information Required

1. **System IP Address** - For a new or defaulted system this will still be 192.168.42.1.
2. **System Password** - For a new or defaulted system this is password.



Procedure: Running Monitor

1. Select **Start | Programs | IP Office | Monitor**.
2. If Monitor has been run before it will attempt to connect with the system which is monitored previously. If you want to monitor a different system use the steps below.
3. Select **File** and then **Select Unit**.
4. Enter the IP Address and Password (see below) of the IP Office control unit you want to monitor.
 - For a new or defaulted control unit the IP address is 192.168.42.1 and the password is password.
 - Following installation, the IP Office control unit can be configured with a specific Monitor Password for Monitor access to an IP Office system. If the IP Office does not have a Monitor Password set, Monitor uses the IP Office's System Password.
5. For an IP Office system, ensure that IP Office is selected.
6. Click **OK**.
7. The first few lines give information about various aspects of the IP Office system. For example:

0ms PRN: Monitor Started IP=192.168.42.203 IP406 DS 3.2(8) IPOffice_1

1ms PRN: LAW=U PRI=0, BRI=0, ALOG=0, ADSL=0, VCOMP=16, MDM=0, WAN=0 MODU=0 LANM=0, CkSRC=0
VMAIL=1(VER=2 TYP=1) CALLS=0(TOT=2)

- LAW = A or MU law system.
 - PRI = PRI channels
 - BRI = BRI channels.
 - ALOG = Analog Trunks
 - VCOMP = VCM channels.
 - MDM = Modem channels.
 - WAN = WAN Ports configured.
 - MODU = Number of external expansion modules.
 - LANM = Number of WAN3 Modules attached.
 - CkSRC = Current Clock Source (ISDN port number - 0 = Internal Clock Source)
 - VMAIL = 1 if connected, 0 if not connected.
 - VER = Version of the voicemail server if obtainable.
 - TYP = Type of Voicemail Server:
0 = None, 1 = PC (Voicemail Lite or Pro), 2 = Line, 3 = Embedded, 4 = Group, 5 = Audix.
 - CALLS = Number of current calls
 - TOT = Total number of calls made to date since last IP Office reboot.
8. Close Monitor until it is need again. When restarted, Monitor will attempt to reconnect using the last settings entered.
 9. For Small Office Edition control units, proceed to [Fitting Trunk Cards](#). For all other control units proceed to [Fitting VCM Cards](#).

5.7 Fitting Trunk Cards (SOE)

All trunk cards are supplied with 2 plastic snap-in stand off pillars and a blanking plate appropriate to the cards ports. The blanking plate is not required with the Small Office Edition.

Warnings

1. Correct anti-static protection steps should be taken before handling circuit boards.
2. During this process power to the IP Office control unit must be switched off and disconnected.

Parts and Equipment Required

1. Trunk Card or Cards

Check that the correct card has been supplied.

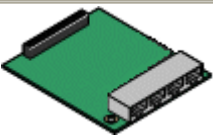
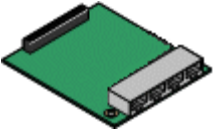
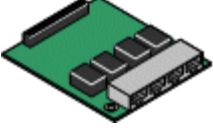
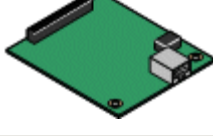
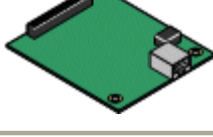
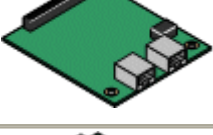
IP400 Trunk Cards		SOE
	Analog Trunk Card (ATM4)	✗
	Analog Trunk Card (ATM4U)	✗
	Quad BRI Trunk Card	✓
	Single PRI T1 Trunk Cards	✓
	Single E1 PRI Trunk Cards	✗
	Single E1R2 Trunk Cards	✗
	Dual PRI Trunk Cards	✗
	WAN Port Card	✓

Tools Required

1. Cross-head screwdriver.
2. Anti-static wrist strap and ground point.
3. IP Office Monitor application.

Procedure

1. Ensure that you wear an anti-static wrist strap that is connected to a suitable grounding point.
2. Remove the top cover (1) from the base cover by removing the four retaining screws (2) on either side.
3. Remove the rear panel (3).
4. Locate the holes for the two trunk card stand off pillars and insert them.
5. Plug the trunk card (5) onto its sockets and stand-off hex. pillars.
 - If fitting a WAN card, replace the rear panel with the new one supplied with the WAN card.
 - Otherwise, on the rear panel, press out all of the knock-out panels (4) to match the trunk card being fitted.
6. Replace the rear panel.
7. Fit the top cover back in place and reinsert the four screws previously removed.

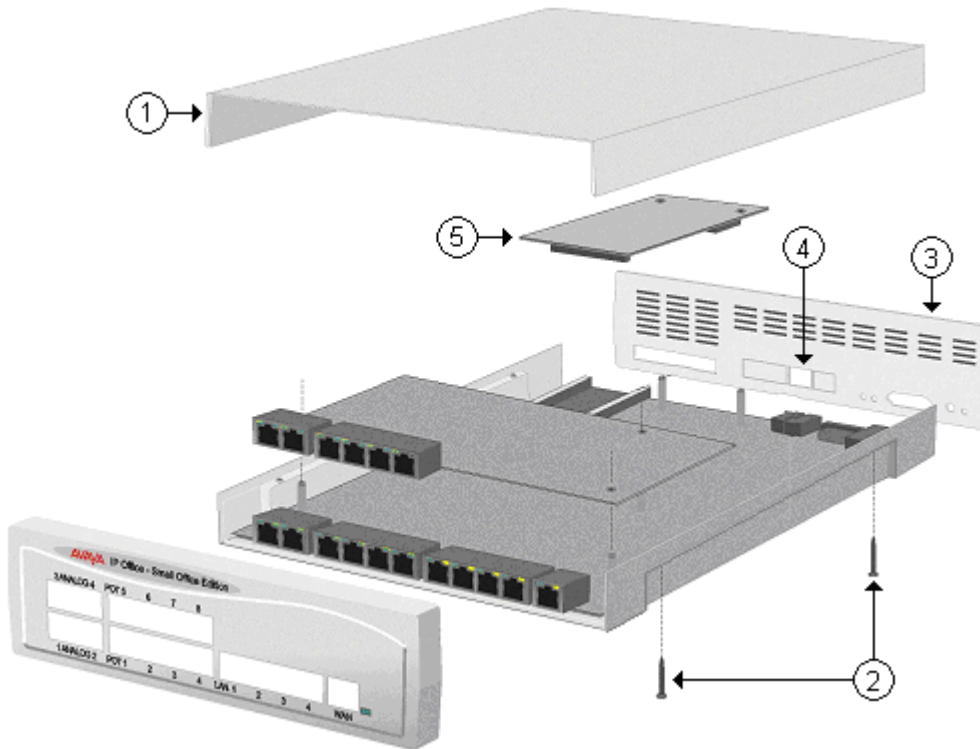

8. Proceed to [Upgrading the Core Software](#).

5.8 Shelf/Wall Mounting

Small Office Edition control units can be shelf or wall mounted. Four screw head retaining slots are moulded into the base of the unit for this purpose. In addition a plastic Z-shaped bracket and screw is supplied with the unit for securing it in position.

⚠ Installation Requirements

- Horizontally on a shelf - leaving sufficient space for the cabling at both front and rear of the unit.
- Vertically from a wall - with the front panel facing down only.

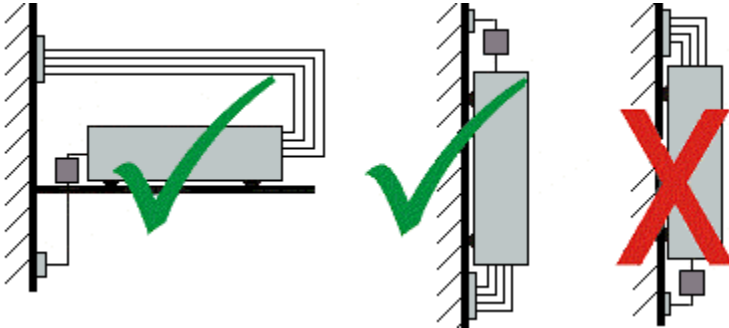

- The Z-shaped bracket must not be used as the sole mounting fixture.



Tools Required

1. Drill and drill bits suitable for the wall fixings selected.
2. Screwdrivers.



Parts and Equipment Required

1. Wall fixings suitable for 3 No.8 screws.
2. 3 x No.8 panhead screws, minimum 25mm long.

Procedure

1. Using a drill size suitable for the selected wall fixing, drill two holes 6.3 inches (160mm) apart either horizontally or vertically.
2. Insert the wall fixings.
3. Insert the two No.8 panhead screws leaving approximately 0.4 inches (10mm) proud of wall.
4. Fit the Z-shaped bracket (2) onto the base of the unit using the M3 self tapping screw supplied.

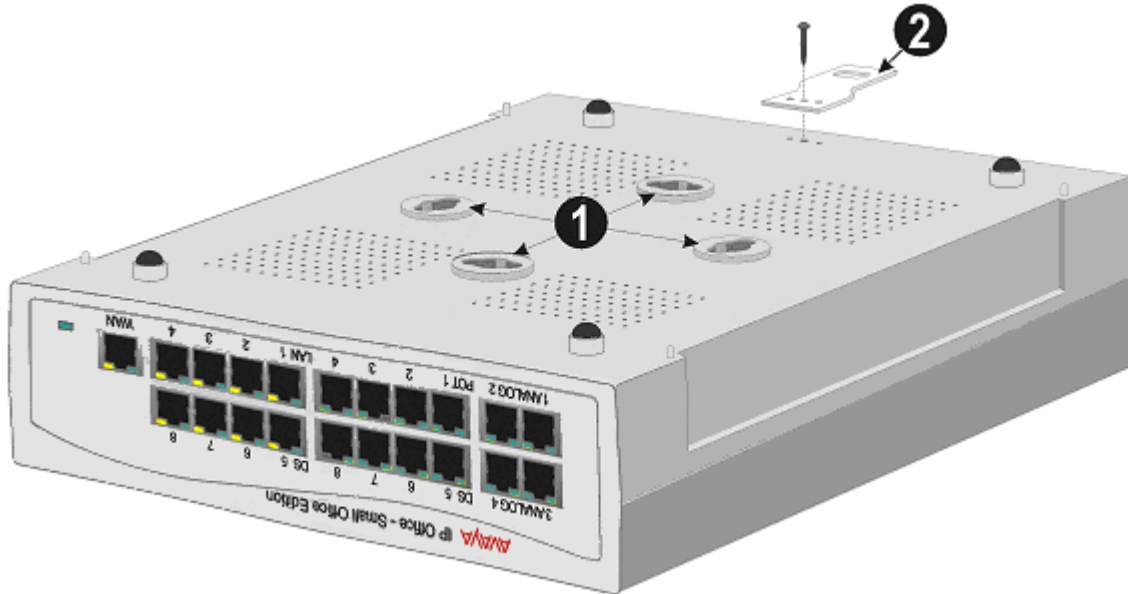

5. Slide the unit onto the two screws, locating them into two of the retaining slots (1).
6. Mark the position of the retaining screw for the Z-bracket.
7. Remove the unit from the wall and drill a hole and insert a wall fixing for the Z-bracket position.
8. Re-position the unit and secure with a No. 8 panhead through the slot of the Z-shaped bracket.



5.9 Grounding (SOE)

Use of ground connections reduces the likelihood of problems in most telephony and data systems. This is especially important in buildings where multiple items of equipment are interconnected using long cable runs, for example phone and data networks.

All IP Office control units and external expansion modules must be connected to a functional ground. In some cases, such as ground start trunks, in addition to being a protective measure this is a functional requirement for the equipment to operate. In other cases it may be a locale regulatory requirement and or a necessary protective step, for example areas of high lightning risk.

- **⚠ WARNING**

During installation do not assume that ground points are correctly connected to ground. Test ground points before relying on them to ground connected equipment.

The ground point on IP Office control units and external expansion modules are marked with a  or  symbol. [Ground](#) connections to these points should use a 14 AWG solid wire with either a green sleeve for a functional ground or green and yellow sleeve for a protective ground.

- **Additional protective equipment**

In addition to grounding, additional protective equipment will be required in the following situations. Refer to "[Out of Building Telephone Installations](#)".

- On any Digital Station or Phones external expansion module connected to an extension located in another building.
- In the Republic of South Africa, on all Analog Trunk external expansion modules (ATM16) and on any control units containing an analog trunk cards (ATM4/ATM4U).

Parts and Equipment Required

1. 14AWG Solid copper wire for ground connection.
2. Cable sleeve matching local regulator requirements. Typically green for a functional ground and green/yellow for a protective ground.

1. 
2. 
3.

Procedure

On the Small Office Edition control unit, the ground point is provided by a 3.5mm jack socket marked with a  symbol on the left of the rear panel. [Ground](#) connections to these points should use a 14 AWG solid wire with either a green sleeve for a functional ground or green and yellow sleeve for a protective ground.

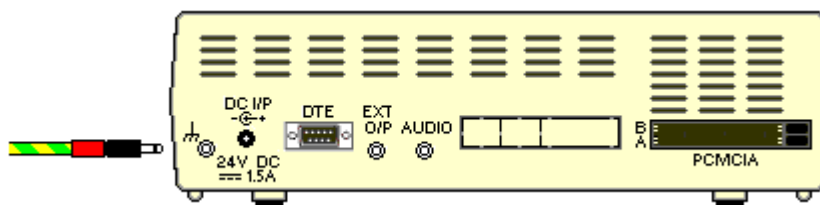

5.10 Upgrading the Core Software

The installed IP Office Manager includes [.bin core software](#) files appropriate to the software level. It can be used to load those .bin file into the control unit and module within the IP Office system.

WARNINGS

- **Check IP Office Technical Bulletins**

Check the latest IP Office Technical Bulletin for the IP Office software release before proceeding any further. It may contain information relating to changes that occurred after this document was completed. Bulletins are available from <http://support.avaya.com>.

- **Upgrading pre-Level 2.1 Systems**

For IP Office Systems with software Level 2.0 or earlier, the upgrade procedure must be done from a PC with a fixed IP address on the same subnet and LAN segment as the IP Office.

- **Multi-Stage Upgrades**

Due to the need to adjust internal memory allocation and configuration storage, for certain upgrades some control units need to perform a multi-stage upgrade process. The table below indicates the required upgrade paths.

Control Unit	.bin File	Unvalidated Only	Validated
Small Office Edition	ip401ng.bin	2.0 > 2.1	2.1 > 3.0 > 3.1 > 3.2 > 3.2(999) > 4.2.

- **Multiple Managers**

If more than one copy of Manager is running it is possible for the IP Office to request BIN files from a different Manager from the one that started the upgrade process. Ensure that only one copy of Manager is running when upgrading an IP Office system.

Information Required

1. **System Password.**

For a new or defaulted system this is password.





Tools Required

1. **Manager PC.**

The Upgrade Wizard tool is part of the Manager application.

Procedure: Upgrade Procedure

1. Using Manager, click  and receive the configuration from the IP Office. If not already done this action creates a BOOTP entry in Manager for the IP Office system. This action also confirms communication between the Manager PC and the IP Office.
2. Select **File | Save Configuration As...** and save a copy of the configuration file onto the PC. This action should be completed before upgrading any IP Office system.
3. Select **File | Advanced | Upgrade.**
4. The UpgradeWiz is started and scans for IP Office modules using the Unit/Broadcast address. Adjust this address and click Refresh if the expected modules are not shown.
5. For each the control unit and module found, the UpgradeWiz displays the module type, its current version of software installed in the unit and the software version of the .bin file that Manager has available.
6. For those units and modules where manager detects that it has a higher version available, the tick box next to the unit or module is automatically selected.
7. If any of the modules have pre-version 2.1 software installed, untick the Validate option.
 -  If this is the case, only continue with the upgrade process using a PC with a fixed IP address on the same LAN domain and physical LAN segment as the IP Office control unit.
8. If a multi-stage upgrade is necessary, use the following additional steps to select the appropriate interim software:
 - Right-click on the upgrade wizard and click **Select Directory.**
 - Upgrading a Small Office Edition to level 4.0:
Select the V3_2_99 folder within the Manager program directory.
 - The upgrade wizard should now list just the control unit as having upgrade software available. For the remainder of the upgrade as detailed below, the upgrade can be rerun again select the final software for the control unit.
9. For those modules which you want to upgrade, tick the check box. For modules where a later version of software is available the check box may have already been automatically ticked.
10. Select **Upgrade.**
11. The system password will be requested. Enter it and click **OK.**
12. **Validated Upgrade**

If using the Validated option, a number of actions take place as follows;

 - Firstly the upgrade wizard performs initial checks on the amount of free RAM memory available in the IP Office system to temporarily store the new BIN files during the upgrade process. If insufficient memory is available, you will be prompted whether to continue with an off-line upgrade or cancel upgrading.
 - If offline is selected, the IP Office is rebooted into offline mode. It may be necessary to use the Refresh option within the Upgrade Wizard to reconnect following the reboot. Validate upgrade can then be attempted to again check the amount of available RAM memory for transfer of BIN files. If the memory is still insufficient, the option is offered to either do an unvalidated upgrade or cancel.
 - The bin files required are transferred to the system and stored in temporary memory.
 - Once all the files have been transferred, the upgrade wizard will prompt whether it okay to proceed with the upgrade process. Select Yes to continue.
 - Each module being upgraded will delete its existing core software, restart and load the new software file that was transferred. This process may take several minutes for each unit. Do not cancel or close the upgrade wizard while this process is running.
13. **Unvalidated Upgrade**

This method of upgrading should be avoided unless absolutely necessary. It is only required for IP Office systems with pre-2.1 software and should only be done from a Manager PC with a fixed IP address running on the same LAN segment and subnet as the IP Office system. During the upgrade the units and modules erases their current software and then request the new software file from Manager.
14. Following the upgrade check that the upgrade wizard now shows that the selected units and modules have upgraded. It may be necessary to select Refresh to update the information in the upgrade wizard display.

5.11 Configuring Security Settings





Currently the system is defaulted, including the security passwords controlling access to the system's security and configuration settings.

 You should read and understand the Security Settings section of the IP Office Manager documentation. That section details the settings and operation of the IP Office security settings and is part of the Manager applications help file.

 **Objective** - Make the control unit configuration settings secure from unauthorized changes by changing the default passwords.

1. 
2. 
3. 

Procedure

1. Select **Start | Programs | IP Office | Manager**.
2. Select **File | Advanced | Security Settings**.
3. The Select IP Office window appears. After a few seconds it should list the control unit that is being setup. The default name used is the control unit's MAC address.
 - If the system required was not found, the address used for the search can be changed. Enter or select the required address in the Unit/Broadcast Address field and then click Refresh to perform a new search.
4. Click the check the box next to the system and then click OK.
5. The name and password request is displayed. As the system has been upgrade to IP Office 3.2 software, the name and password now requested are a Service User name and password stored within the IP Office. The default name and password for security settings access are security and securitypwd.
6. The Manager should load and display the IP Office control unit's security settings.
7. Select  **General**. On the tab displayed, the Security Administrator section contains the default name and password used to access the IP Office's security settings. Click Change and set a new password. The default password is securitypwd. Click OK.
8. Click OK to save the changes to that tab.
9. Select  **Rights Groups** and then the **Administrator Group**.
10. Select the **System Status** tab and check that **System Status Access** is selected. This is required for the System Status Application.
11. Click **OK** to save the changes to that tab.
12. Select  **Service Users**. This tab shows the settings for one of the Service Users who have names and passwords used for access to the configuration settings on the IP Office control unit. Click Change and set a new password. The default password matches the name. Click OK.
13. Click **OK** to save the changes made on that tab.
14. Click > button to display the settings for the next Service User and repeat the process in the previous two steps to change their password.
15. Click **OK**.
16. The new security settings can now be sent to the IP Office control unit. Click .
17. The original name and password used to load the settings will be requested. Enter the details and click **OK**.

5.12 Receiving a Configuration (3.2+)

The process here applies to systems running IP Office 3.2 and higher.

 **Objective** - Receive a configuration from an IP Office running IP Office 3.2 or higher software.

Information Required

1. **Service User Name and Password**

The defaults for full configuration access are Administrator and Administrator. However these should have been changed as part of the installation process, see [16. Configuring Security Settings](#).

Procedure: Receiving the Configuration

1. Select **Start | Programs | IP Office | Manager**.
2. Click  in the main toolbar or select **File | Open Configuration** from the menu bar.
3. The **Select IP Office** window appears. After a few seconds it should list the control unit that is being setup. The default name used is the control units MAC address.
 - If the system required was not found, the address used for the search can be changed. Enter or select the required address in the Unit/Broadcast Address field and then click Refresh to perform a new search.
4. Click the check the box next to the system and then click OK.
5. The name and password request is displayed. The name and password must match one of those setup through the security settings. The default name and password for full configuration settings access is Administrator and Administrator.
6. Successful receiving of the configuration is shown by the full configuration tree being shown in the left-hand panel. With no configuration loaded the navigation pane shows just BOOTP and Operator entries.

IP Office Default Settings

The following are the basic default configuration settings for an IP Office system.

System	Name	MAC address of the control unit.	
	System Password	password	
	License Server IP Address	255.255.255.255	
LAN1		LAN1	LAN2/WAN
	IP address	192.168.42.1.	192.168.43.1
	IP Mask	255.255.255.0	255.255.255.0
	DHCP Mode	Server	Server
	No of DHCP IP Addresses	200.	200.

• **Extensions and Users**

A user is automatically created for each physical extension port detected in the system. Users are assigned extension numbers starting from 201. User names take the form Extn201, Extn202,

• **Hunt Group**

A single hunt group 200 called Main is created and the first 10 users are placed into that hunt group as members.

• **Incoming Call Routes**

Two default incoming call routes are created. Voice calls are routed to the hunt group Main. Data calls are routed to the RAS user DialIn.

5.13 Running the System Status Application

In the previous process ([Configuring Security Settings](#)) the Administrator service user was configured to be able to use the IP Office System Status Application (SSA) with the control unit. This application is useful during the following installation processes as it can be used to validate the correct installation of equipment.

By default the System Status Application is enabled for the Administrator service user. For other service users, use of System Status Application must be enabled through the IP Office's security settings.

 **Objective** - Allow SSA to be used to check the correct installation of additional equipment.

 **Procedure**

1. Select **Start | Programs | IP Office | System Status**.
2. On the Logon menu enter the required details. For a default systems these will be:
 - **Control Unit IP Address:** 192.168.42.1
 - **Services Base TCP Port:** 50804
 - **User Name:** Administrator
 - **Password:** Administrator
3. Click Logon.
4. If the details are correct, SSA should show Waiting for connection and then the IP Office system status.

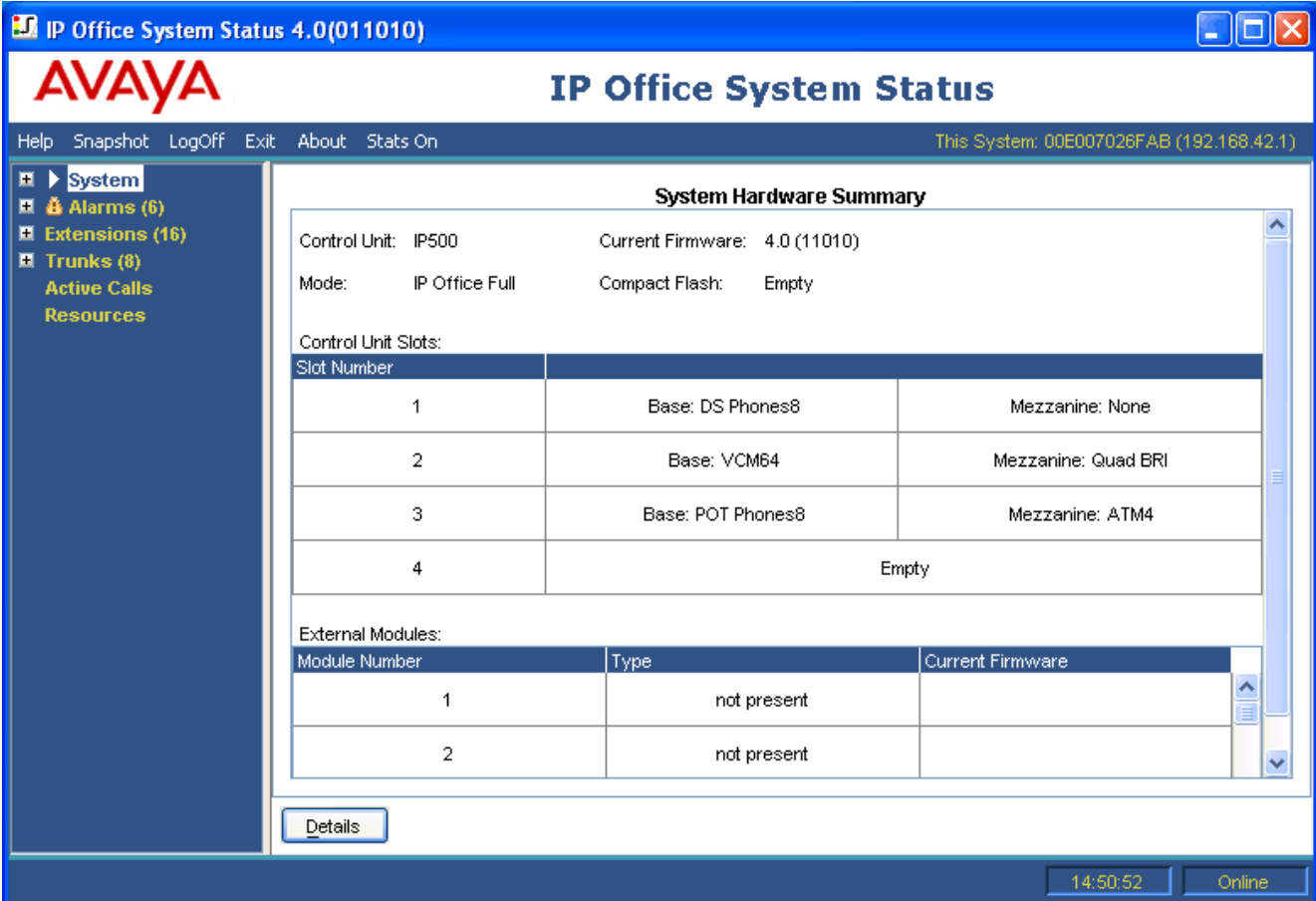

IP Office System Status 4.0(011010)

AVAYA IP Office System Status

Help Snapshot LogOff Exit About Stats On This System: 00E007026FAB (192.168.42.1)

System

Alarms (6)

Extensions (16)

Trunks (8)

Active Calls

Resources

System Hardware Summary

Control Unit: IP500 Current Firmware: 4.0 (11010)

Mode: IP Office Full Compact Flash: Empty

Control Unit Slots:

Slot Number		
1	Base: DS Phones8	Mezzanine: None
2	Base: VCM64	Mezzanine: Quad BRI
3	Base: POT Phones8	Mezzanine: ATM4
4	Empty	

External Modules:

Module Number	Type	Current Firmware
1	not present	
2	not present	

Details

14:50:52 Online



Chapter 6.

IP400 Basic Installation

6. IP400 Basic Installation

6.1 Unpacking

Use the following procedure when unpacking any equipment supplied by Avaya or an Avaya distributor.

 **Objective** - To check that the correct equipment has been supplied and that no damage has occurred during transit.

 **Information Required**

1. **Equipment Checklist.**
Draw up an installation checklist of the parts and equipment expected.

 **Procedure**

1. **Check for Package Damage.**
Before unpacking any equipment, check for any signs of damage that may have occurred during transit. If any damage exists bring it to the attention of the carrier.
2. **Check the Correct Parts Have Been Delivered.**
Check all cartons against the packing slip and ensure that you have the correct items. Report any errors or omissions to the equipment supplier.
3. **Retain All Packaging and Documentation.**
While unpacking the equipment, retain all the packaging material. Fault returns are accepted only if repackaged in the original packaging. If performing a staged installation, the original packaging will also assist when repacking equipment to be moved to the final install site.
4. **Ensure that Anti-Static Protection Measures are Observed**
Ensure that anti-static protection measures are observed at all times when handling equipment with exposed electrical circuit boards.
5. **Check All Parts.**
Visually inspect each item and check that all the necessary documentation and accessory items have been included. Report any errors or omissions to the dealer who supplied the equipment.
6. **Check All Documentation.**
Ensure that you read and retain any documentation included with any items.

6.2 Installing the Admin Applications

This procedure covers installation of applications in the IP Office Admin suite.

 **Objective** - To install the applications necessary for the installation and maintenance of an IP Office system.

Information Required

1. Which IP Office Admin Suite applications are being installed?

The following list indicates those that are required for installation and configuration:

- **System Monitor - Install**
Monitor is a tool intended primarily for Avaya technicians and engineers. However it is able to report on all aspects of IP Office operation and is therefore an important tool for diagnostics.
- **Feature Key Server - Optional**
The Feature Key Server should only be installed if the PC will host the parallel port or USB port Feature Key dongle for the IP Office system.
- **Manager - Install**
This application is required to edit and manage the software on the IP Office system.
- **Voicemail Mail Lite - Optional**
Only install this application if no other voicemail such as Voicemail Pro or embedded voicemail is being installed. IP Office Lite is not supported by IP500 systems running in IP Office Standard Edition mode.
- **System Status Application - Install**
This application is used with IP Office 4.0 systems to show equipment and resource within the system, alarms and calls in progress.
- **Previous System Monitor - IP400 Install/IP500 Optional**
For IP400 control unit this version of monitor is required until the system is upgraded to IP Office 4.0 software.
- **Call Status - Optional**
This application is only supported for pre-4.0 IP Office systems. For IP Office 4.0 and higher it has been replaced by the System Status Application above.

Parts Required

1. IP Office Administrator Applications CD.

2. Windows PC

This should meet the requirements of the administrator applications being installed. If a server PC from the customer installation is available, for example for Voicemail Pro, use that PC. The specification below is just for IP Office Manager. If other applications are to be installed on the PC then their requirements should also be met.

Requirement	Minimum	Recommended
Processor	600MHz Pentium or AMD Opteron, AMD Athlon64, AMD Athlon XP.	800MHz Pentium or AMD Opteron, AMD Athlon64, AMD Athlon XP.
RAM	128MB	256MB
HD Space	1GB - 800MB for .NET2, 200MB for Manager.	1.4GB - 800MB for .NET2, 600MB for the full IP Office Admin suite.
Display	800 x 600 - 256 Colors	1024 x 768 - 16-bit High Color
Operating System	Windows XP Professional with SP2. Windows 2003 Server. Windows 2003 SBS. Note: 64-bit versions of the operating systems above are not supported.	

Procedure: Installing the IP Office Admin Applications

- Using the **Add or Remove Programs** option in the Windows Control Panel, check that the PC does not already have a version of the IP Office Admin suite installed.
 - If 'yes' and the suite is a pre-IP Office 3.2 version, remove the existing IP Office Admin suite via Add/Remove Programs.
 - If the existing suite is IP Office 3.2 or higher, it is possible to upgrade without removing the previous installation.
- Insert the IP Office Administrator Applications CD. The installation process should auto start. If it does not auto start, open the CD contents and double-click **setup.exe**.
- Select the language you want to use for the installation process. This does not affect the language used by Manager which will attempt to match your Windows regional setting. Click **Next >**.
- Select whether only the current Windows logon account should be able to run the Admin Suite applications or whether they will be available to all users of the PC. Click **Next >**.
 - The previous selection does not affect the IP Office Feature key server application, if installed. That application runs as a service whenever the PC is running.
- If required select the destination to which the applications should be installed. We recommend that you accept the default destination. Click **Next >**.
- The next screen is used to select which applications in the suite should be installed. Clicking on each will display a description of the application. Click on the ▼ next to each application to change the installation selection. When you have selected the installations required, click **Next >**.

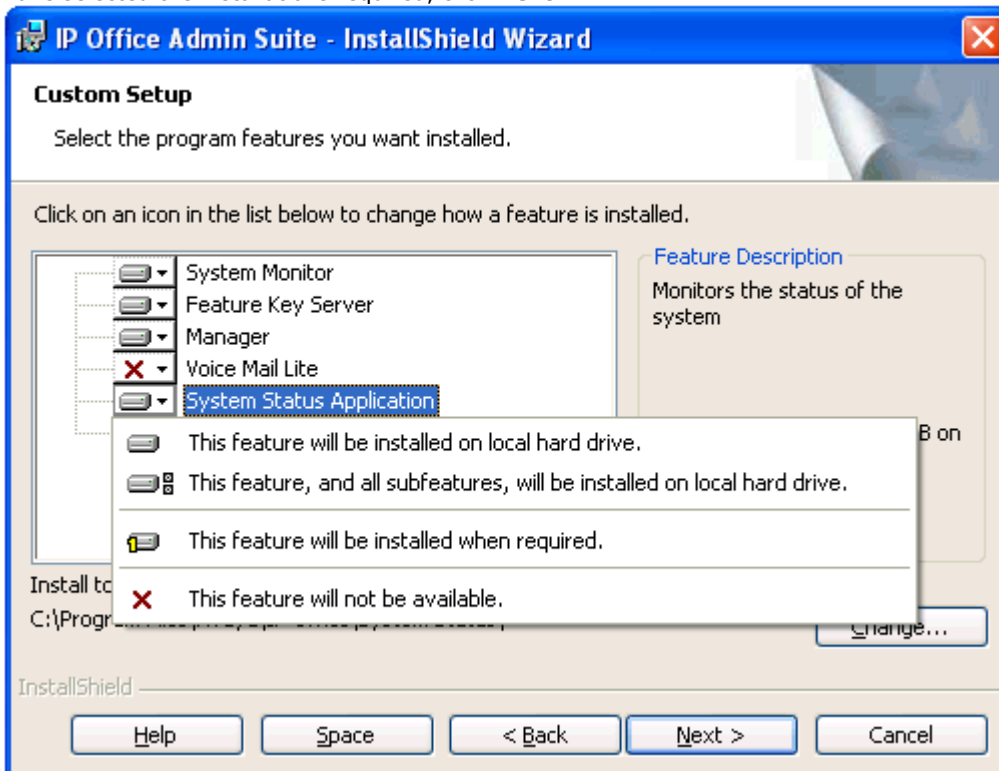

- For IP Office system installations, ensure that at minimum System Monitor and Manager are selected.
 - Only select Voice Mail Lite if this PC will also be the customer's Voicemail Lite server PC.
 - Deselect Feature Key Server unless this PC will be hosting a Parallel port or USB port Feature Key dongle for the customer's IP Office system.
- Click **Install**.
 - Installation of Windows .Net2 components may be required. If dialogs for this appear, follow the prompts to install .Net.
 - If requested, reboot the PC.

6.3 Control Unit Power Up

This procedure starts a new IP Office control unit not connected to any LAN. In this scenario the IP Office control unit will assume its default configuration settings.

 **Objective** - To power up the IP Office control unit to a known state with a known set of defaults.

Parts and Equipment Required

1. Switched power outlet socket.
2. IP Office Control Unit.
3. Locale Specific Power Cord.

Procedure

1. Remove the control unit from its box and check its condition. Check that an external power supply unit has been included with the control unit.
2. Connect the external power supply unit to the control unit.
3. Connect the power cord from the power supply outlet to the external power supply unit.
 - Power cords must not be attached to the building surface or run through walls, ceilings, floors and similar openings. Installation measures must be taken to prevent physical damage to the power supply cord, including proper routing of the power supply cord and provision of a socket outlet near the fixed equipment or positioning of the equipment near a socket outlet.
4. Switch on power to the control unit.
5. Observe the center LED on the front of the control unit. Initially this LED will be red. After approximately 10 seconds it should change to green. During this time other LED's may flash as the unit goes through its power on self test cycle.

IP Office Default Settings

The following are the basic default configuration settings for an IP Office system.

System	Name	MAC address of the control unit.	
	System Password	password	
	License Server IP Address	255.255.255.255	
LAN*		LAN1	LAN2/WAN
	IP address	192.168.42.1.	192.168.43.1
	IP Mask	255.255.255.0	255.255.255.0
	DHCP Mode	Server	Server
	No of DHCP IP Addresses	200.	200.

*See **Default DHCP/Data Settings** detail below.

• **Extensions and Users**

A user is automatically created for each physical extension port detected in the system. Users are assigned extension numbers starting from 201. User names take the form Extn201, Extn202,

• **Hunt Group**

A single hunt group 200 called Main is created and the first 10 users are placed into that hunt group as members.

• **Incoming Call Routes**

Two default incoming call routes are created. Voice calls are routed to the hunt group Main. Data calls are routed to the RAS user DialIn.

• **Default Short Codes**

IP400 control units are manufactured as either A-Law or U-Law variants. For IP500 control units, A-Law or U-Law variant operation is determined by the IP500 Smart Card installed. Depending on the variant, different sets of short codes are created for the default configuration. Refer to the IP Office Manager application help for full details.

• **Default DHCP/Data Settings**

When a defaulted IP Office control unit is switched on, it requests IP address information from a DHCP Server on the network. This operation will occur whether the LAN cable is plugged in or not.

- If a DHCP server responds within approximately 10 seconds, the control unit defaults to being a DHCP client and uses the IP address information supplied by the DHCP server.

-
- If no DHCP Server responds, the control unit defaults to being the DHCP server for the LAN using the following settings:
 - For its LAN1 it allocates the IP address 192.168.42.1 and IP Mask 255.255.255.0. It supports 200 DHCP clients using the addresses range 192.168.42.2 and 192.168.42.201, the IP Mask 255.255.255.0 and default gateway address 192.168.42.1 (the Control Unit's LAN1 address).
 - For its LAN2 if supported, it allocates the IP address 192.168.43.1 and IP Mask 255.255.255.0.
 - Note that the IP Office does not check that these addresses are valid and or available on the network.
 - This mode of operation will persist for subsequent power ups, until a config save occurs due to one of the following
 - The unit performs its automatic midnight backup.
 - A configuration is merged using IP Office Manager.
 - A soft reboot is performed using IP Office Manager.
 - A software upgrade is performed.

6.4 Connecting the Manager PC

At this stage we will directly connect the Manager PC to the new IP Office control unit. For this the PC will need to be set to a fixed IP address in the same subnet range as the IP Office control unit's default address (192.168.42.1/255.255.255.255).

 **Objective** - Physically connecting the Manager PC and the IP Office without needing to adjust or configure any intervening equipment.



Parts and Equipment Required

1. **Manager PC.**
2. **LAN Cable.**
- **IP Office Small Office Edition, IP406 V2 and IP500 control units:**
A standard RJ45-RJ45 LAN cable can be used.
- **IP412 Control Unit:**
A RJ45-RJ45 cross-over LAN cable is required.



Procedure: Direct Connection to a Defaulted IP Office Control Unit

1. Check that the TCP/IP properties for the Manager PC's Local Area Network connection are set as follow:
 - **Fixed IP address:** 192.168.42.203
 - **Subnet mask:** 255.255.255.0
 - **Default gateway:** 192.168.42.1.
2. Connect the LAN cable from the PC's LAN port the LAN 1 port on the IP Office control unit.
3. Check that the orange LED lamp on the IP Office LAN port is on. The green LED may also be flickering as it indicates traffic across the LAN connection.
4. Select **Start | Run** and enter **cmd**.
5. In the command window that appears enter ping 192.168.42.1. The results should show a number of ping replies from the IP Office. This confirms basic communication between the Manager PC and the IP Office.
6. If there are no ping replies
 - Enter **ipconfig**. The results should list the IP address settings of the Manager PC as required above and with no mention of DHCP being used. Enter exit.
7. Check the cable connection.

6.5 Receiving a Configuration (Pre 3.2)

The following is the normal procedure for receiving a copy of the IP Office configuration from a new or defaulted control unit running pre-3.2 IP Office core software.

 **Objective** - This process tests the communication between the Manager application and the IP Office control unit.

 **Information Required**

1. **System Password** - For a new or defaulted system this is password.

1. 
2. 
3. 

Procedure: Receiving the Configuration from a Pre-3.2 IP Office Control Unit

1. Select **Start | Programs | IP Office | Manager**.

2. Click  in the main toolbar or select **File | Open Configuration** from the menu bar.

3. The Select IP Office window appears. After a few seconds it should list the control unit that is being setup. The default name used is the control units MAC address.

- If the system required was not found, the address used for the search can be changed. Enter or select the required address in the Unit/Broadcast Address field and then click Refresh to perform a new search.

4. Click the check the box next to the system and then click OK.

5. The name and password request is displayed. The name must match a Manager operator and the password must match the IP Office control unit's system password. For a defaulted IP Office with pre-3.2 IP Office software enter Administrator and password.

- The name and password used above are applicable to new control units which are supplied with a basic IP Office 2.1 level of software. Once upgraded to IP Office 3.2 the name and password required change.

6. Successful receiving of the configuration is shown by the full configuration tree being shown in the left-hand panel. With no configuration loaded the configuration tree shows just BOOTP and Operator.

6.6 Using Monitor

Monitor is a tool intended primarily for Avaya technicians and engineers. However it is also able to report the presence of hardware devices that are not reported by the IP Office Manager application and is therefore an important tool during the installation process. This process shows how System Monitor can be used to obtain information about the components installed with the IP Office control unit.



Objective

To introduce System Monitor so that it can be used during later stages of installation to confirm the correct installation of some components into the control unit.



Warnings

1. Running Monitor can create a high network load on the IP Office system. Therefore it should only be used when necessary and should be closed when not needed.



Information Required

1. **System IP Address** - For a new or defaulted system this will still be 192.168.42.1.
2. **System Password** - For a new or defaulted system this is password.



Procedure: Running Monitor

1. Select **Start | Programs | IP Office | Monitor**.
2. If Monitor has been run before it will attempt to connect with the system which is monitored previously. If you want to monitor a different system use the steps below.
3. Select **File** and then **Select Unit**.
4. Enter the IP Address and Password (see below) of the IP Office control unit you want to monitor.
 - For a new or defaulted control unit the IP address is 192.168.42.1 and the password is password.
 - Following installation, the IP Office control unit can be configured with a specific Monitor Password for Monitor access to an IP Office system. If the IP Office does not have a Monitor Password set, Monitor uses the IP Office's System Password.
5. For an IP Office system, ensure that IP Office is selected.
6. Click **OK**.
7. The first few lines give information about various aspects of the IP Office system. For example:

0ms PRN: Monitor Started IP=192.168.42.203 IP406 DS 3.2(8) IPOffice_1

1ms PRN: LAW=U PRI=0, BRI=0, ALOG=0, ADSL=0, VCOMP=16, MDM=0, WAN=0 MODU=0 LANM=0, CkSRC=0
VMAIL=1(VER=2 TYP=1) CALLS=0(TOT=2)

- LAW = A or MU law system.
 - PRI = PRI channels
 - BRI = BRI channels.
 - ALOG = Analog Trunks
 - VCOMP = VCM channels.
 - MDM = Modem channels.
 - WAN = WAN Ports configured.
 - MODU = Number of external expansion modules.
 - LANM = Number of WAN3 Modules attached.
 - CkSRC = Current Clock Source (ISDN port number - 0 = Internal Clock Source)
 - VMAIL = 1 if connected, 0 if not connected.
 - VER = Version of the voicemail server if obtainable.
 - TYP = Type of Voicemail Server:
0 = None, 1 = PC (Voicemail Lite or Pro), 2 = Line, 3 = Embedded, 4 = Group, 5 = Audix.
 - CALLS = Number of current calls
 - TOT = Total number of calls made to date since last IP Office reboot.
8. Close Monitor until it is need again. When restarted, Monitor will attempt to reconnect using the last settings entered.
 9. For Small Office Edition control units, proceed to [Fitting Trunk Cards](#). For all other control units proceed to [Fitting VCM Cards](#).

6.7 Fitting VCM Cards

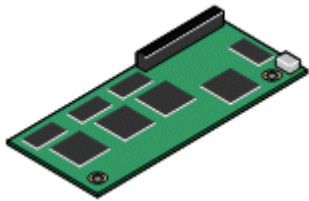

VCM cards are used to provide voice compression channels for calls between IP and non-IP devices, devices being both trunks and extensions. VCM cards with differing numbers of voice compression channels are available.

 Objective - To fit the card and confirm its presence after restarting the IP Office.

Warnings

1. Correct anti-static protection steps should be taken before handling circuit boards.
2. During this process power to the IP Office control unit must be switched off and disconnected.

Parts and Equipment Required

1. VCM Card.

Check that the correct card has been supplied. The number and maximum capacity supported varies between different IP Office control units. All cards are supplied with 2 plastic snap-in stand off pillars.

VCM Cards		SAP Code	IP406 V2	IP412
Voice Compression Modules (25ms echo cancellation)	VCM5	700185119	✓	✓
	VCM10	700185127	✓	✓
	VCM20	700185135	✓	✓
	VCM30	700293939	✓	✓
Voice Compression Modules (64ms echo cancellation)	VCM4	700359854	✓	✓
	VCM8	700359862	✓	✓
	VCM16	700359870	✓	✓
	VCM24	700359888	✓	✓
Number of VCM cards.			1	2
Maximum number of channels.			30	60

Tools Required.

1. Cross-head screwdriver.
2. Anti-static wrist strap and ground point.
3. IP Office Monitor application.

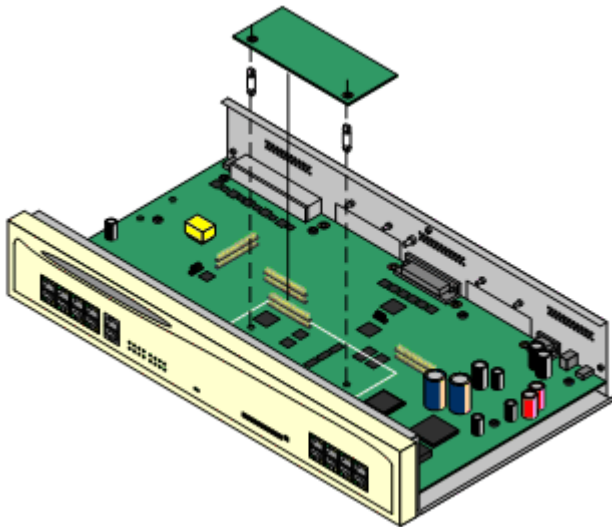
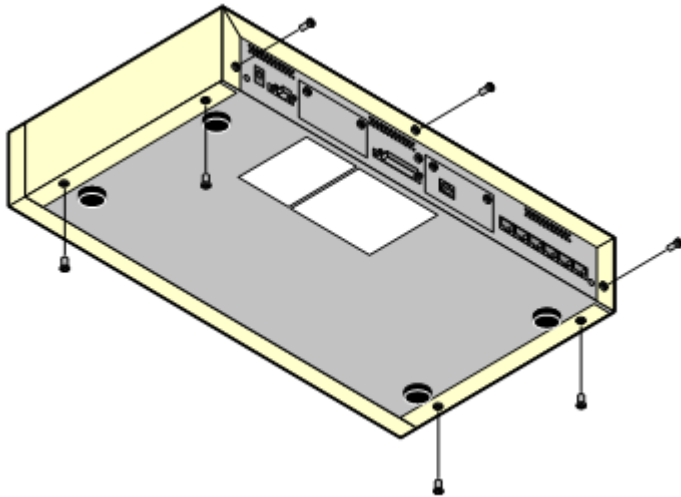
Procedure: Installing VCM Cards

1. Check that correct card has been supplied.
2. Ensure that you are wearing an anti-static wrist strap connected to a suitable ground point.
3. Remove the 7 screws fixing the IP Office control unit cover and slide the cover off the control unit.
4. Locate the position for the card and its jumper block.
5. Using the card as a template locate the two holes in the control unit circuit board. Insert the stand off pillars into these holes. For the IP412 either slot can be used in any order.

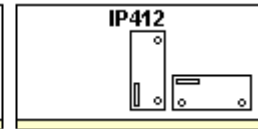

6. Using minimal force and checking that the pins are correctly located, push the card onto the jumper block and stand off pillars.
7. If other cards are being fitted, proceed to [08. Fitting Modem Cards](#).
8. Slide the control unit cover back on and replace the cover screws.
9. Reapply power to the control unit and check that it restarts correctly.
10. Using the IP Office Monitor application, confirm that the correct number of voice compression channels are reported. They are shown by the value VCOMP= at the start of the Monitor trace.

6.8 Fitting Modem Cards



 **Objective** - To fit and verify the presence of a modem card.

Warnings

1. Correct anti-static protection steps should be taken before handling circuit boards.
2. During this process power to the IP Office control unit must be switched off and disconnected.

Parts and Equipment Required

1. **Modem Card**

Check that the correct card has been supplied. The number and maximum capacity supported varies between different IP Office control units. All cards are supplied with 2 plastic snap-in stand off pillars.

Modem Cards	SAP Code	IP406 V2	IP412
Internal Modem Card/Modem 12 Provides 12 V.90 modem channels.	700343452	✓	✓
Modem 2 Card Provides 2 V.90 modem channels.	700185226	✓	✓

Tools Required

1. Cross-head screwdriver.
2. Anti-static wrist strap and ground point.
3. IP Office Monitor application.

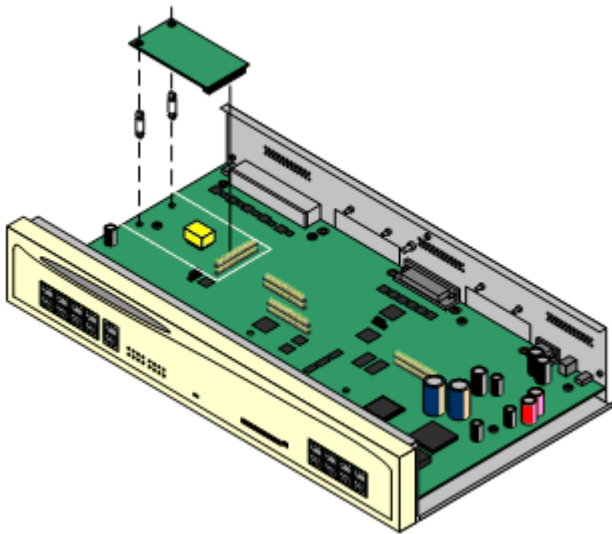
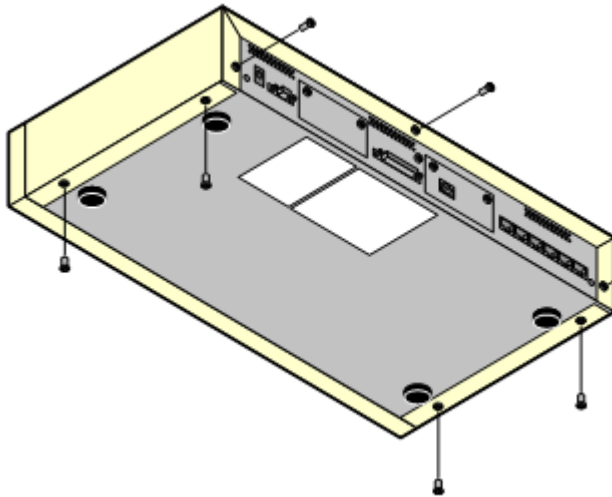
Procedure: Installing Modem Cards

1. Check that correct card has been supplied.
2. Ensure that you are wearing a anti-static wrist strap connected to a suitable ground point.
3. Remove the 7 screws fixing the IP Office control unit cover and slide the cover off the unit.
4. Locate the position for the card and its jumper block.
5. Using the card as a template locate the two holes in the control unit circuit board. Insert the stand off pillars into these holes.

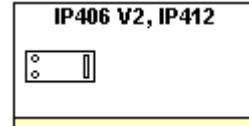

6. Using minimal force and checking that the pins are correctly located, push the card onto the jumper block and stand off pillars.
7. If other cards are being fitted, proceed to [Fitting Trunk Cards](#).
8. Slide the control unit cover back on and replace the cover screws.
9. Reapply power to the control unit and check that it restarts correctly.
10. Using the IP Office Monitor application, confirm that the correct number of modem channels are now reported. They are shown by the value MDM= when Monitor first connects to the control unit.

6.9 Fitting Trunk Cards

All trunk cards are supplied with 2 plastic snap-in stand off pillars and a blanking plate appropriate to the cards ports. E1R2 coaxial trunk cards include additional grounding strap, screws and bolts.

Warnings

1. Correct anti-static protection steps should be taken before handling circuit boards.
2. During this process power to the IP Office control unit must be switched off and disconnected.

Parts and Equipment Required

1. Trunk Card or Cards

Check that the correct card has been supplied. The number and maximum capacity supported varies between different IP Office control units. All cards are supplied with 2 plastic snap-in stand off pillars.

IP400 Trunk Cards	IP406 V2	IP412
Analog Trunk Card (ATM4)	✓	✓
Analog Trunk Card (ATM4U)	✓	✓
Quad BRI Trunk Card	✓	✓
Single PRI T1 Trunk Cards	✓	✓
Single E1 PRI Trunk Cards	✓	✓
Single E1R2 Trunk Cards	✓	✓
Dual PRI Trunk Cards	✓	✓
WAN Port Card	✗	✗

Tools Required

1. Cross-head screwdriver.
2. Anti-static wrist strap and ground point.
3. IP Office Monitor application.

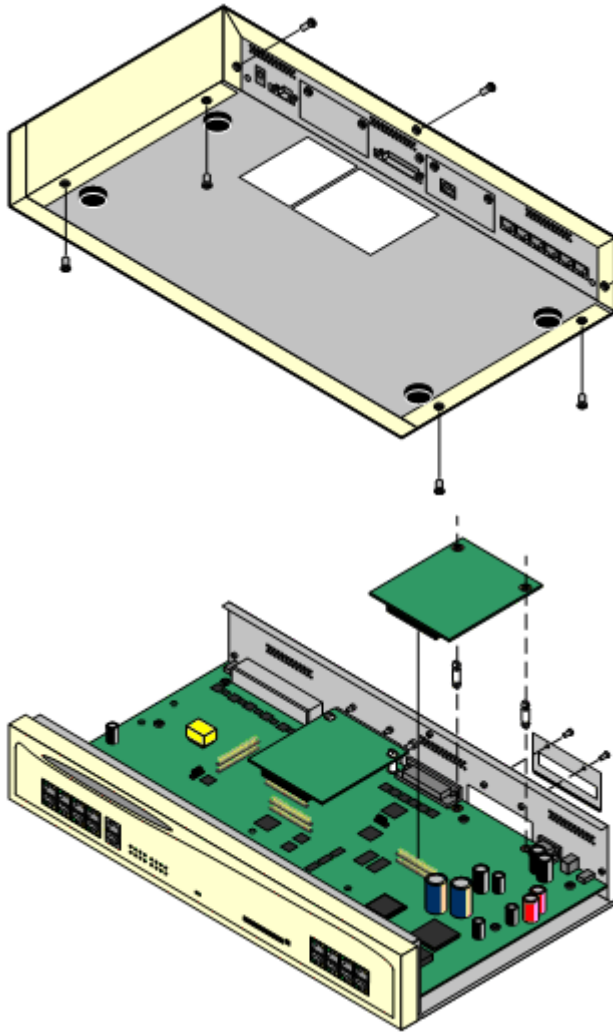
Procedure: Fitting Trunk Cards

1. Check that correct card has been supplied. Dual PRI cards are only supported in Slot A of the IP406 V2 control unit or both slots on an IP412 control unit.
2. Ensure that you are wearing a ground wrist strap connected to a suitable ground point.
3. Remove the 7 screws fixing the IP Office control unit cover and slide the cover off the unit.
4. Remove the 2 screws fixing the slot blanking plate.
5. Attach the replacement blanking plate.
6. Using the card as a template locate the two holes in the control unit circuit board. Insert the stand off pillars into these holes.
 - Except where otherwise indicated, it is recommended that Slot B is used first.
 - The IP406 V2 only supports dual PRI cards in Slot A.
7. Using minimal force and checking that the pins are correctly located, push the card onto the jumper block and stand off pillars.
8. Coaxial E1R2 Trunk Cards Only:
For these trunk cards care must be taken to ground the connectors. See the following section for details. This must be completed before proceeding any further.
9. Reapply power to the control unit and check that it restarts correctly.
10. Using Manager, receive the IP Office configuration and check that the lines are now shown.
11. If Modem and VCM cards were also fitted whilst the control unit was open, use Monitor to check that the VCOMP and MDM values match the cards fitted.
12. Proceed to [Adding Expansion Modules](#).

Grounding E1R2 Coaxial Connections

E1R2 coaxial trunk cards must be grounded correctly and require the IP Office control unit to be connected to a protective ground.

Normally the ends of one connection is grounded. For example, if the exchange Tx1 is grounded, the IP Office Rx1 should also be grounded. However this must be confirmed with the line provider to establish which ends they want grounded.

1. 2. 3. Procedure

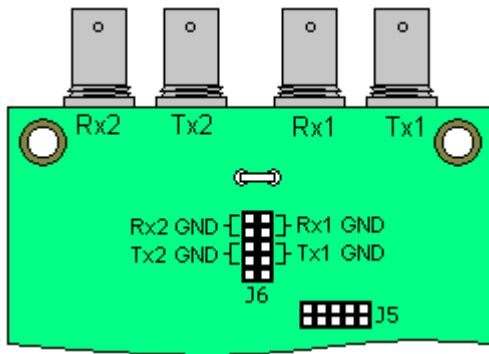

1. Use the two jumpers supplied with the card, match the ground selection of the line provider. For example, if the line provider wants the IP Office Rx1 grounded, place a jumper across the two Rx1 pins of jumper block J6.
2. Connect the ground strap spade end (B) to the spade connection on the board.
3. Connect the other end of the ground strap (C) to the blanking plate using the long securing screw supplied with the card.
4. Ensure that the coaxial connector ports are locked to the blanking plate using the nuts provided.
5. Continue with trunk card installation as in **Stage 9a**.

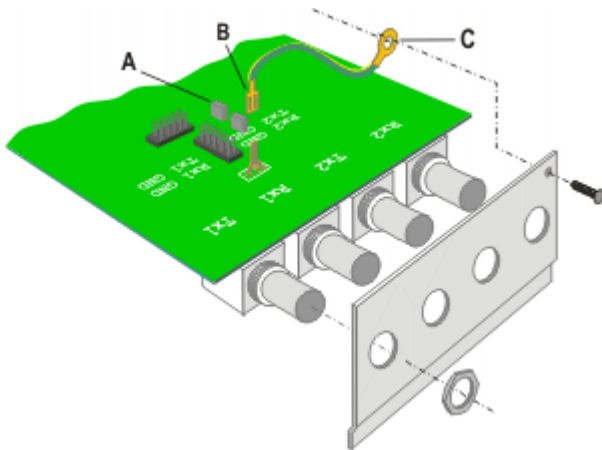

6.10 Rack Mounting

All IP Office control units and expansion modules except the Small Office Edition can be rack mounted. To do this requires a separate rack mounting kit for each unit and module.

⚠ Installation Requirements

In addition to the existing [environmental requirements](#) for an IP Office system, the following additional factors must be considered when rack mounting a unit:

1. Rack Positioning

Ensure compliance with the rack manufacturers safety instructions. For example check that the rack legs have been lowered and fixing brackets have been used to stop toppling.

2. Elevated Operating Ambient

If installed in a closed or multi-unit rack assembly, the operating ambient temperature of the rack environment may be greater than room ambient. Therefore, consideration should be given to installing the equipment in an environment compatible with the maximum ambient temperature (T_{ma}) specified by the manufacturer.

3. Reduced Air Flow

Installation of the equipment in a rack should be such that the amount of air flow required for safe operation of the equipment is not compromised. Proper ventilation must be maintained. The side ventilation slots on the IP500 control unit should not be covered or blocked.

4. Mechanical Loading

Mounting of the equipment in the rack should be such that a hazardous condition is not achieved due to uneven mechanical loading.

5. Circuit Overloading

Consideration should be given to the connection of the equipment to the supply circuit and the effect that overloading of the circuits might have on overcurrent protection and supply wiring. Appropriate consideration of equipment nameplate ratings should be used when addressing this concern.

6. Reliable Earthing

Reliable earthing of rack-mounted equipment should be maintained. Particular attention should be given to supply connections other than direct connections to the branch circuit (e.g. use of power strips).

📦 Parts and Equipment Required

• Rack Mounting Kit (SAP 700210800)

This kit contains all the components required for the rack mounting of a single control unit or expansion module. This includes screws for fixing of the brackets to the module and bolts for securing the module in the rack.

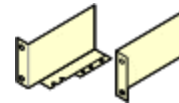

• Barrier Box Rack Mounting Kit (SAP 700293905)

Barrier boxes must be used for [out-of-building analog phone extensions](#). This bracket allows up to 8 IP Office barrier boxes to be rack mounted and simplifies the number of connections to the protective ground point in the rack.

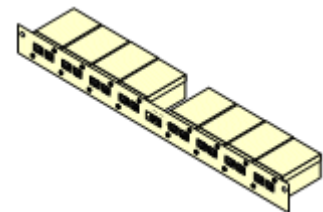

- Must be used when more than 3 Barrier Boxes are in use.
- A maximum of 16 Barrier Boxes are supported on any module.

Procedure: Rack Mounting

1. Using the small screws (2), fix the main brackets (6) to the module.

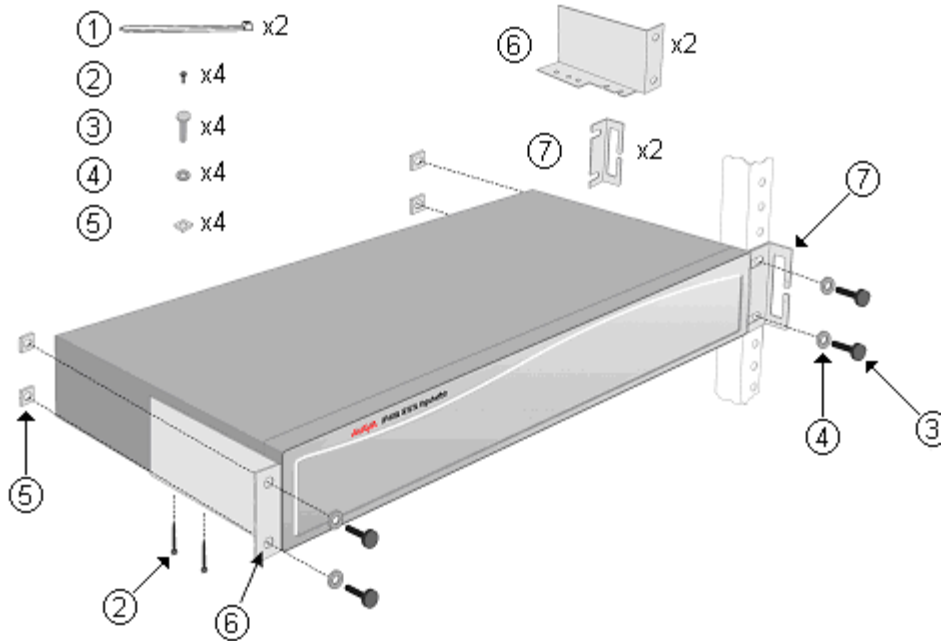

2. Using the nut (5), bolt (3) and washer (4) provided, loosely fit the module into the rack system in its intended position.

3. If required, add the cable guide brackets (7) before finally tightening the nuts and bolts.

4. If required, connect the module ground points to the rack ground point. This should be done using 14AWG solid wire with either a green sleeve (functional ground) or green and yellow sleeve (protective ground).

5. Continue installation and setup as normal.

6.11 Adding Expansion Modules

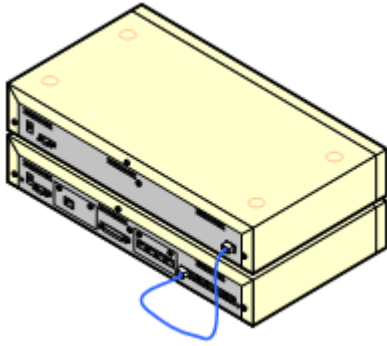

External expansion modules, except the WAN3, connect to the IP Office control unit using a blue 1 meter (3'3") expansion interconnect cable.

- **Note**

Expansion modules are only detected by the IP Office control unit, if the Expansion modules are powered up and running before the control unit is started. The control unit power on process includes a delay to ensure that if all modules in a system are started at the same time, the expansion modules should complete their power up before the control unit.

Each module is supplied with an expansion connect cable and a [power supply unit](#). An appropriate [locale specific power cord](#) for the power supply unit, and [cables](#) for the ports on the front of the module must be ordered separately.

Warnings

- No cable other than an Expansion Interconnect cable should be used. Use of any alternate cable will lead to system failure.

Installation Requirements

1. Installation space either on or under the existing IP Office control unit.
2. Switched power outlet socket.
3. Free EXPANSION port on the rear of the control unit.
4. Grounding Requirements
 - 4.1. **Functional Grounding**
Connection of a [functional ground](#) is:
 - Recommend for all modules.
 - Connection of a functional ground is mandatory for Analog Trunk module.
 - 4.2. **Protective Grounding**
Connections of a protective ground via [surge protection equipment](#) is:
 - Mandatory for Analog trunk modules in the Republic of South Africa.
 - Mandatory for Digital Station and Phone modules connected to out of building extensions.
 - Mandatory for Digital Station V2 and Phone V2 modules.



Tools Required

1. Manager PC.
2. [Tools for rack mounting](#) (optional).



Parts and Equipment Required

1. External Expansion Module.
Each module is supplied with a suitable external power supply unit and a RJ45-RJ45 expansion interconnect cable.
2. [Power cord for the power supply unit](#).
3. [Rack mounting kit](#) (optional).
4. Cable labelling tags.

1.
2.
3.

Procedure

1. Switch off power to the IP Office control unit.
2. Attach the external expansion module's power supply.
3. Connect the blue expansion interconnect cable from the module's EXPANSION port to the first free EXPANSION port on the control unit.

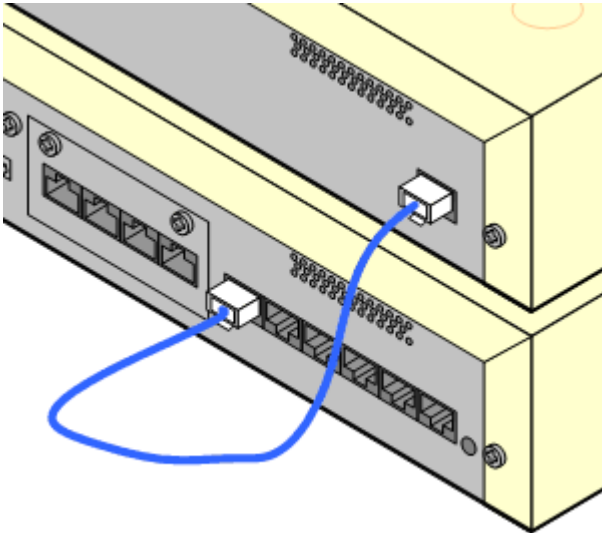

4. Make careful note of the port used and include this detail on the cable label and any other system records.
5. Switch on power to the module. Wait for the center LED on the front of the module to change from red to green.
6. Switch on power to the control unit.
7. Once the control unit has rebooted, using Manager receive the system configuration.
8. Click on  **Unit** in the left-hand panel.
9. Check that the list of units shown in the right-hand panel is correct.
10. Proceed to [Adding a WAN3 Module](#).

6.12 Adding a WAN3 Module

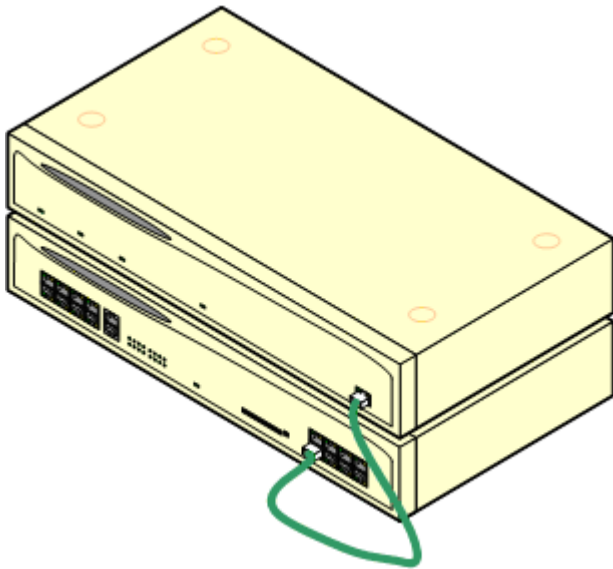

WAN3 expansion modules connect to the IP Office control unit using a LAN cable. It is preferred that the cable is connected directly to the IP Office control unit rather than via any other equipment. A green 1 meter (3'3") LAN interconnect cable is supplied with the module for this purpose though a replacement cross-over cable is required if connecting to an IP412 control unit.

The WAN3 module requires its own IP address on the same subnet as the IP Office control unit. A WAN3 module obtains that address using DHCP so a DHCP server is required for installation.

This module is supplied with a LAN interconnect cable and a [power supply unit](#). An appropriate [locale specific power cord](#) for the power supply unit, and [cables](#) for the WAN ports on the rear of the module must be ordered separately.

Installation Requirements

1. Installation space either on or under the existing IP Office control unit.
2. Switched power outlet socket.
3. System password.
4. Free LAN port on the front of the control unit.
5. Grounding Requirements
 - 5.1. Functional Ground - Connection of a [functional ground](#) is recommend for all modules.



Tools Required

1. Manager PC.
2. DHCP server (preferably the IP Office itself).
3. Tools for rack mounting (optional).





Parts and Equipment Required

1. WAN3 10/100 Module
Each module is supplied with a suitable external power supply unit and a RJ45-RJ45 LAN interconnect cable.
2. For the IP412 control unit an RJ45-RJ45 LAN crossover cable is required.
3. WAN Cables.
A V.24, V.35 or X.21 WAN cable is required for connection to each WAN port. The cable used determines the signalling provided by that port.
4. [Power cord for the power supply unit](#).
5. [Rack mounting kit \(optional\)](#).
6. Cable labeling tags.

Procedure: Adding a WAN3 Module

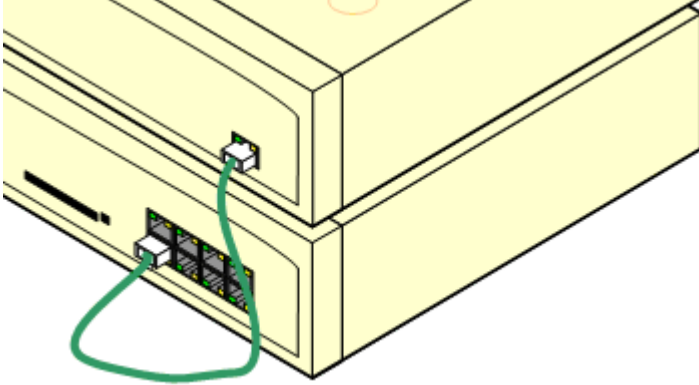
1. Switch off power to the IP Office control unit.
2. Connect the WAN3 module to the control unit using the LAN cable.



3. Switch on power to the WAN3 10/100 module.
4. Switch on power to the IP Office Control Unit.
5. Using Manager receive the configuration from the IP Office system.
6. Select  **Control Unit**. If the WAN3 10/100 module is not listed, right-click and select New. A Select WAN unit window appears which will allow the network to be scanned for the WAN3 unit.
7. When the unit is located, select it and then OK.
8. Send the configuration back to the IP Office system.



6.13 Grounding

Use of ground connections reduces the likelihood of problems in most telephony and data systems. This is especially important in buildings where multiple items of equipment are interconnected using long cable runs, for example phone and data networks.

All IP Office control units and external expansion modules must be connected to a functional ground. In some cases, such as ground start trunks, in addition to being a protective measure this is a functional requirement for the equipment to operate. In other cases it may be a locale regulatory requirement and or a necessary protective step, for example areas of high lightning risk.

-  **WARNING**

During installation do not assume that ground points are correctly connected to ground. Test ground points before relying on them to ground connected equipment.

The ground point on IP Office control units and external expansion modules are marked with a  or  symbol. [Ground](#) connections to these points should use a 14 AWG solid wire with either a green sleeve for a functional ground or green and yellow sleeve for a protective ground.

- **Additional protective equipment**

In addition to grounding, additional protective equipment will be required in the following situations. Refer to "[Out of Building Telephone Installations](#)".

- On any Digital Station or Phones external expansion module connected to an extension located in another building.
- In the Republic of South Africa, on all Analog Trunk external expansion modules (ATM16) and on any control units containing an analog trunk cards (ATM4/ATM4U).



Tools Required



1. M4 Cross-Head Screwdriver.
2. Tools suitable for crimping a cable spade.



Parts and Equipment Required

1. 14AWG Solid copper wire for ground connection.
2. Cable sleeve matching local regulator requirements. Typically green for a functional ground and green/yellow for a protective ground.

Procedure

The ground point on IP Office control units and expansion modules are marked with a  or  symbol. [Ground](#) connections to these points should use a 14 AWG solid wire with either a green sleeve for a functional ground or green and yellow sleeve for a protective ground.

IP400 Control Units

On IP406 V2 and IP412 control units, the ground point is a 4mm screw located adjacent to trunk card Slot B.

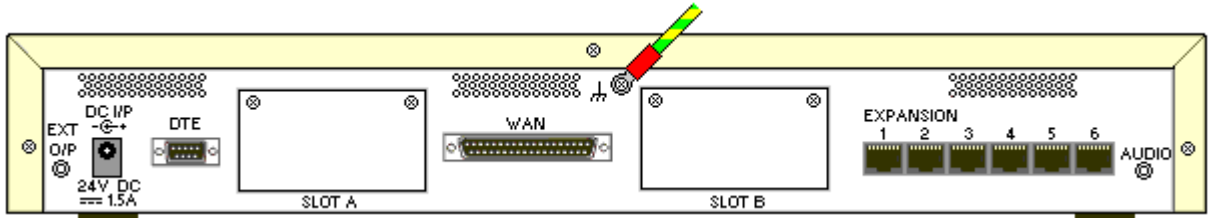

- On some older units, the dedicated ground point screw is not present. In those cases, the left-hand 3mm fixing screw on the Slot B blanking plate can be used as an alternate ground connection point. A toothed washer should be added to ensure good contact.

Expansion Modules

On expansion modules, the ground point is a 4mm screw located towards the right on the rear of the module.

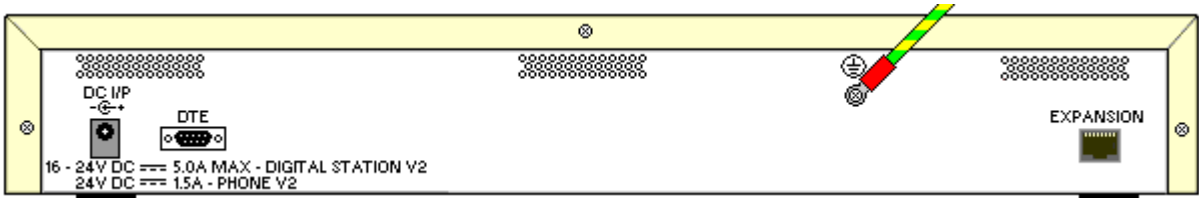

- On some older modules, the dedicated ground point screw is not present. In those cases, the top-center cover fixing screw (3mm) can be used as an alternative ground connection point. A toothed washer should be added to ensure good contact.

6.14 Upgrading the Core Software

The installed IP Office Manager includes [.bin core software](#) files appropriate to the software level. It can be used to load those .bin file into the control unit and module within the IP Office system.

WARNINGS

- **Check IP Office Technical Bulletins**

Check the latest IP Office Technical Bulletin for the IP Office software release before proceeding any further. It may contain information relating to changes that occurred after this document was completed. Bulletins are available from <http://support.avaya.com>.

- **WAN3 10/100 Modules**

Upgrade each WAN3 10/100 module separately and only after having upgraded the control unit and any other expansion modules.

- **Upgrading pre-Level 2.1 Systems**

For IP Office Systems with software Level 2.0 or earlier, the upgrade procedure must be done from a PC with a fixed IP address on the same subnet and LAN segment as the IP Office.

- **Multi-Stage Upgrades**

Due to the need to adjust internal memory allocation and configuration storage, for certain upgrades some control units need to perform a multi-stage upgrade process. The table below indicates the required upgrade paths.

Control Unit	.bin File	Unvalidated Only	Validated
IP406 V2	ip406u.bin	–	2.1 > 3.0 > 3.0(999) > 3.1 > 3.1(999) > 3.2 > 4.2.
IP412	ip412.bin	1.3 > 2.1	2.1 > 3.0 > 3.1 > 3.2 > 4.2.

- **Multiple Managers**

If more than one copy of Manager is running it is possible for the IP Office to request BIN files from a different Manager from the one that started the upgrade process. Ensure that only one copy of Manager is running when upgrading an IP Office system.

Information Required



1. **System Password** - For a new or defaulted system this is password.



Tools Required

1. **Manager PC** - The Upgrade Wizard tool is part of the Manager application.

Procedure: Upgrade Procedure

1. Using Manager, click  and receive the configuration from the IP Office. If not already done this action creates a BOOTP entry in Manager for the IP Office system. This action also confirms communication between the Manager PC and the IP Office.
2. Select **File | Save Configuration As...** and save a copy of the configuration file onto the PC. This action should be completed before upgrading any IP Office system.
3. Select **File | Advanced | Upgrade.**
4. The UpgradeWiz is started and scans for IP Office modules using the Unit/Broadcast address. Adjust this address and click Refresh if the expected modules are not shown.
5. For each the control unit and module found, the UpgradeWiz displays the module type, its current version of software installed in the unit and the software version of the .bin file that Manager has available.
6. For those units and modules where manager detects that it has a higher version available, the tick box next to the unit or module is automatically selected.
7. If any of the modules have pre-version 2.1 software installed, untick the Validate option.
 -  If this is the case, only continue with the upgrade process using a PC with a fixed IP address on the same LAN domain and physical LAN segment as the IP Office control unit.
8. If a multi-stage upgrade is necessary, use the following additional steps to select the appropriate interim software:
 - Right-click on the upgrade wizard and click **Select Directory.**
 - **Upgrading an IP406 V2 to level 3.1 or higher:**
Select the V3_0_99 folder within the Manager program directory.
 - **Upgrading an IP406 V2 to level 3.2 or higher:**
Select the V3_1_999 folder within the Manager program directory.
 - The upgrade wizard should now list just the control unit as having upgrade software available. For the remainder of the upgrade as detailed below, the upgrade can be rerun again select the final software for the control unit.
9. For those modules which you want to upgrade, tick the check box. For modules where a later version of software is available the check box may have already been automatically ticked. If doing a multistage upgrade, only the control unit is selectable for the first stage.
 - For systems including WAN3 modules, untick the WAN3 modules. Each WAN3 module should be upgraded separately once the control unit and modules in the same system have been upgraded.
10. Select **Upgrade.**
11. The system password will be requested. Enter it and click OK.
12. **Validated Upgrade**
If using the Validated option, a number of actions take place as follows;
 - Firstly the upgrade wizard performs initial checks on the amount of free RAM memory available in the IP Office system to temporarily store the new BIN files during the upgrade process. If insufficient memory is available, you will be prompted whether to continue with an off-line upgrade or cancel upgrading.
 - If offline is selected, the IP Office is rebooted into offline mode. It may be necessary to use the Refresh option within the Upgrade Wizard to reconnect following the reboot. Validate upgrade can then be attempted to again check the amount of available RAM memory for transfer of BIN files. If the memory is still insufficient, the option is offered to either do an unvalidated upgrade or cancel.
 - The bin files required are transferred to the system and stored in temporary memory.
 - Once all the files have been transferred, the upgrade wizard will prompt whether it okay to proceed with the upgrade process. Select Yes to continue.
 - Each module being upgraded will delete its existing core software, restart and load the new software file that was transferred. This process may take several minutes for each unit. Do not cancel or close the upgrade wizard while this process is running.
13. **Unvalidated Upgrade**
This method of upgrading should be avoided unless absolutely necessary. It is only required for IP Office systems with pre-2.1 software and should only be done from a Manager PC with a fixed IP address running on the same LAN segment and subnet as the IP Office system. During the upgrade the units and modules erases their current software and then request the new software file from Manager.
14. Following the upgrade check that the upgrade wizard now shows that the selected units and modules have upgraded. It may be necessary to select Refresh to update the information in the upgrade wizard display.
15. Repeat the process as required. For example if doing a multi-stage control unit upgrade or if there are WAN3 modules in the system that are being upgraded separately.
16. Proceed to [Configuring Security Settings.](#)

6.15 Configuring Security Settings





Currently the system is defaulted, including the security passwords controlling access to the system's security and configuration settings.

 You should read and understand the Security Settings section of the IP Office Manager documentation. That section details the settings and operation of the IP Office security settings and is part of the Manager applications help file.

 **Objective** - Make the control unit configuration settings secure from unauthorized changes by changing the default passwords.

1. 
2. 
3. 

Procedure

1. Select **Start | Programs | IP Office | Manager**.
2. Select **File | Advanced | Security Settings**.
3. The Select IP Office window appears. After a few seconds it should list the control unit that is being setup. The default name used is the control unit's MAC address.
 - If the system required was not found, the address used for the search can be changed. Enter or select the required address in the Unit/Broadcast Address field and then click Refresh to perform a new search.
4. Click the check the box next to the system and then click OK.
5. The name and password request is displayed. As the system has been upgrade to IP Office 3.2 software, the name and password now requested are a Service User name and password stored within the IP Office. The default name and password for security settings access are security and securitypwd.
6. The Manager should load and display the IP Office control unit's security settings.
7. Select  **General**. On the tab displayed, the Security Administrator section contains the default name and password used to access the IP Office's security settings. Click Change and set a new password. The default password is securitypwd. Click OK.
8. Click OK to save the changes to that tab.
9. Select  **Rights Groups** and then the **Administrator Group**.
10. Select the **System Status** tab and check that **System Status Access** is selected. This is required for the System Status Application.
11. Click **OK** to save the changes to that tab.
12. Select  **Service Users**. This tab shows the settings for one of the Service Users who have names and passwords used for access to the configuration settings on the IP Office control unit. Click Change and set a new password. The default password matches the name. Click OK.
13. Click **OK** to save the changes made on that tab.
14. Click > button to display the settings for the next Service User and repeat the process in the previous two steps to change their password.
15. Click **OK**.
16. The new security settings can now be sent to the IP Office control unit. Click .
17. The original name and password used to load the settings will be requested. Enter the details and click **OK**.

6.16 Receiving a Configuration (3.2+)

The process here applies to systems running IP Office 3.2 and higher.

 **Objective** - Receive a configuration from an IP Office running IP Office 3.2 or higher software.

Information Required

1. Service User Name and Password

The defaults for full configuration access are Administrator and Administrator. However these should have been changed as part of the installation process, see [16. Configuring Security Settings](#).

1. 

Procedure: Receiving the Configuration

1. Select **Start | Programs | IP Office | Manager**.
2. Click  in the main toolbar or select **File | Open Configuration** from the menu bar.
3. The **Select IP Office** window appears. After a few seconds it should list the control unit that is being setup. The default name used is the control units MAC address.
 - If the system required was not found, the address used for the search can be changed. Enter or select the required address in the Unit/Broadcast Address field and then click Refresh to perform a new search.
4. Click the check the box next to the system and then click OK.
5. The name and password request is displayed. The name and password must match one of those setup through the security settings. The default name and password for full configuration settings access is Administrator and Administrator.
6. Successful receiving of the configuration is shown by the full configuration tree being shown in the left-hand panel. With no configuration loaded the navigation pane shows just BOOTP and Operator entries.

IP Office Default Settings

The following are the basic default configuration settings for an IP Office system.

System	Name	MAC address of the control unit.	
	System Password	password	
	License Server IP Address	255.255.255.255	
LAN1		LAN1	LAN2/WAN
	IP address	192.168.42.1.	192.168.43.1
	IP Mask	255.255.255.0	255.255.255.0
	DHCP Mode	Server	Server
	No of DHCP IP Addresses	200.	200.

• Extensions and Users

A user is automatically created for each physical extension port detected in the system. Users are assigned extension numbers starting from 201. User names take the form Extn201, Extn202,

• Hunt Group

A single hunt group 200 called Main is created and the first 10 users are placed into that hunt group as members.

• Incoming Call Routes

Two default incoming call routes are created. Voice calls are routed to the hunt group Main. Data calls are routed to the RAS user DialIn.

6.17 Running System Status Application

In the previous process ([Configuring Security Settings](#)) the Administrator service user was configured to be able to use the IP Office System Status Application (SSA) with the control unit. This application is useful during the following installation processes as it can be used to validate the correct installation of equipment.

By default the System Status Application is enabled for the Administrator service user. For other service users, use of System Status Application must be enabled through the IP Office's security settings.

 **Objective** - Allow SSA to be used to check the correct installation of additional equipment.

1. 

Procedure

1. Select **Start | Programs | IP Office | System Status**.
2. On the Logon menu enter the required details. For a default systems these will be:
 - **Control Unit IP Address:** 192.168.42.1
 - **Services Base TCP Port:** 50804
 - **User Name:** Administrator
 - **Password:** Administrator
3. Click Logon.
4. If the details are correct, SSA should show Waiting for connection and then the IP Office system status.

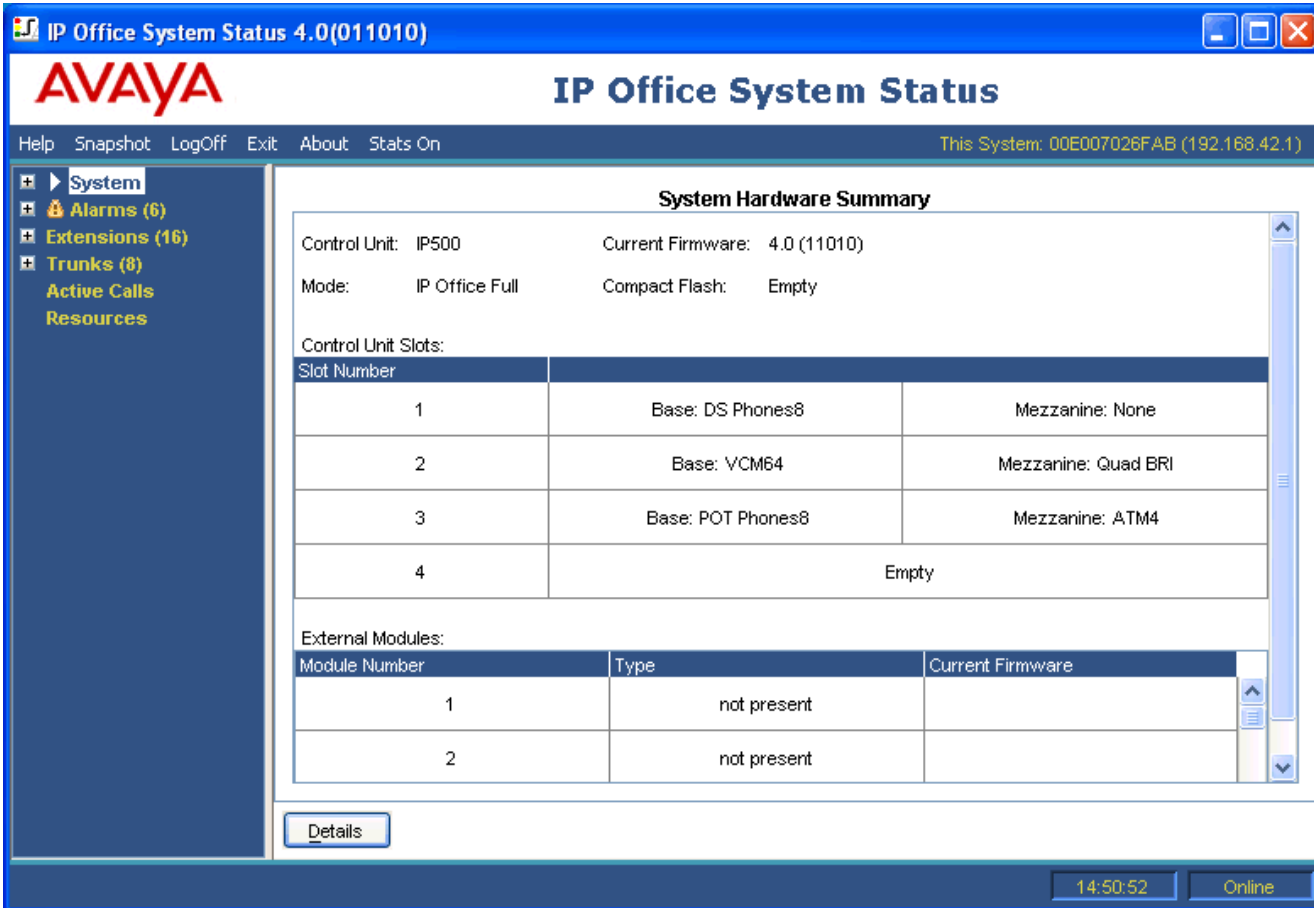

IP Office System Status 4.0(011010)

AVAYA IP Office System Status

Help Snapshot LogOff Exit About Stats On This System: 00E007026FAB (192.168.42.1)

System Hardware Summary

Control Unit: IP500 Current Firmware: 4.0 (11010)
Mode: IP Office Full Compact Flash: Empty

Control Unit Slots:

Slot Number		
1	Base: DS Phones8	Mezzanine: None
2	Base: VCM64	Mezzanine: Quad BRI
3	Base: POT Phones8	Mezzanine: ATM4
4	Empty	

External Modules:

Module Number	Type	Current Firmware
1	not present	
2	not present	

Details

14:50:52 Online

Chapter 7.

IP500 Basic Installation

7. IP500 Basic Installation

7.1 Tools Required



The following is a general summary of the tools required. Additional tools and equipment will be required for wall and or rack mounting and to fashion ground cable connections suitable to local requirements.



Tools Required.

1. 5mm Flat-blade screwdriver.
2. Crosshead screwdriver.
3. Anti-static wrist strap and ground point.
4. PC with IP Office Admin suite (Manager and System Status application) and RJ45 Ethernet LAN port.
5. RJ45-RJ45 Ethernet LAN Cable.
6. Tools and materials suitable for ground cabling.

7.2 Read the Documentation



Ensure that you have read this manual in full before starting installation. Also include the installation documentation for any other equipment and applications being installed as part of the IP Office system.

- **⚠ IP Office Technical Bulletins**

Ensure that you have obtained and read the IP Office Technical Bulletin relating to the IP Office software release which you intend to install on the IP500 Office. This bulletin will contain important information that may not have been included in this manual. IP Office Technical Bulletins are available from the web sites listed below.

Other IP Office Installation Manuals

The following components of IP Office are outside the range of a basic IP Office installation. They are covered by separate installation and configuration documentation. If those components are to be part of the IP Office system installation, that documentation should be obtained, read and understood prior to the installation.

- **4600/5600 Series IP Phone Installation.**
- **Embedded Voicemail Installation.**
- **Voicemail Lite Installation.**
- **Voicemail Pro Installation.**
- **Delta Server (SMDR) Installation.**
- **Compact Business Center (CBC) Installation.**
- **Compact Contact Center (CCC) Installation.**
- **Contact Store Installation.**
- **Compact DECT Installation.**
- **IP DECT Installation.**
- **3600 Series Wireless IP Installation.**
- **Phone Manager Installation Manual.**
- **SoftConsole Installation Manual.**
- **Conference Center Installation Manual.**

Information Web Sites

IP Office documentation is available from the following web sites.

- **Avaya Support** - <http://support.avaya.com>
Contains documentation and other support materials for Avaya products including IP Office. Copies of the IP Office CD images are available from this site and updated core software .bin files.
- **Avaya IP Office Knowledge Base** - <http://marketingtools.avaya.com/knowledgebase>
Access to an on-line regularly updated version of the IP Office Knowledge Base. Currently this link is only available to Avaya Business Partners while running an ARA account (Avaya Remote Access) connection.

7.3 Unpacking

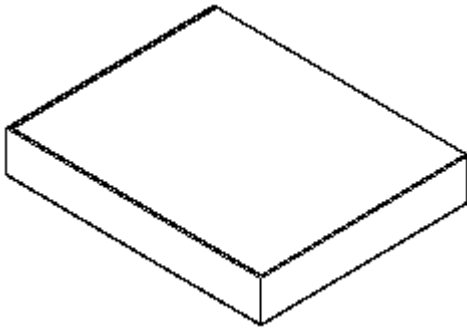

Use the following procedure when unpacking any equipment supplied by Avaya or an Avaya reseller or distributor.

 **Objective** - To check that the correct equipment has been supplied and that no damage has occurred during transit.

 **Information Required**

1. **Equipment Checklist.**

Draw up an installation checklist of the parts and equipment expected.

1. 
2. 
3.

Procedure

1. **Check for Package Damage.**

Before unpacking any equipment, check for any signs of damage that may have occurred during transit. If any damage exists bring it to the attention of the carrier.

2. **Check the Correct Parts Have Been Delivered.**

Check all cartons against the packing slip and ensure that you have the correct items. Report any errors or omissions to the equipment supplier.

3. **Retain All Packaging and Documentation.**

While unpacking the equipment, retain all the packaging material. Fault returns are accepted only if repackaged in the original packaging. If performing a staged installation, the original packaging will also assist when repacking equipment to be moved to the final install site.

4. **Ensure that Anti-Static Protection Measures are Observed.**

Ensure that anti-static protection measures are observed at all times when handling equipment with exposed electrical circuit boards.

5. **Check All Parts.**

Visually inspect each item and check that all the necessary documentation and accessory items have been included. Report any errors or omissions to the dealer who supplied the equipment.

6. **Check All Documentation.**

Ensure that you read and retain any documentation included with the equipment.

7.4 IP500 Card Installation

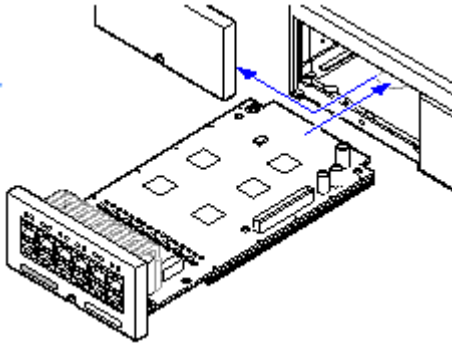

At this stage fit all the internal IP500 cards before powering up the IP500 Office control unit. These processes should be performed with no power to the control unit and following full anti-static precautions.

1. [Fitting IP500 Trunk Daughter Cards.](#)
2. [Fitting IP400 Legacy Cards.](#)
3. [Installing IP500 Cards.](#)

Warnings

1. Correct anti-static protection steps should be taken before handling circuit boards.
2. During this process power to the IP Office control unit must be switched off and disconnected.

General Notes

1. Cards can be fitted in any order into any available slots.
2. It is recommended that cards are fitted from left to right.
3. There are restrictions to the number of supported cards of some types. When such a limit is exceeded, the right-most card of that type will not function.
4. Ensure that you use the labels supplied to identify the card fitted into the control unit.

1. IP500 Trunk Daughter Card Installation

IP500 trunk daughter cards can be fitted to any IP500 base card except the IP500 Legacy Card Carrier.

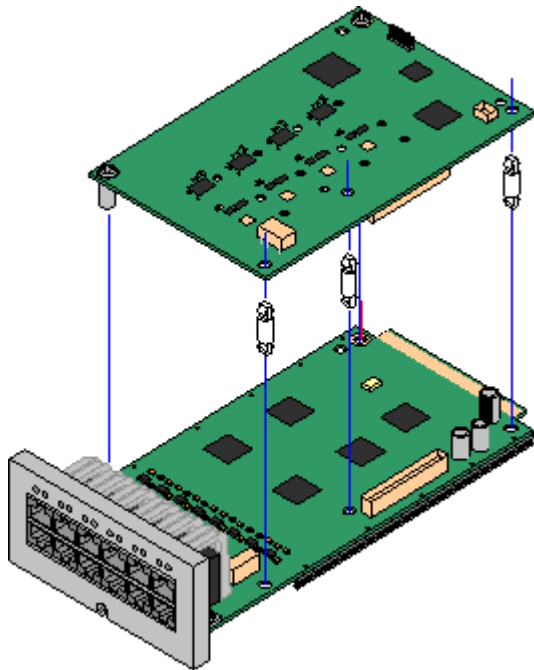

 **Objective** - To fit a IP500 trunk card to an IP500 base card.

Warnings

1. Correct anti-static protection steps should be taken before handling circuit boards.
2. During this process power to the IP Office control unit must be switched off and disconnected.

Parts and Equipment Required

1. Any IP500 base card except the IP500 Legacy Card Carrier base card.
2. IP500 Trunk Card
3. 5 Stand Off Pillars
These are supplied with the trunk daughter card.
 - With the release of the IP500 PRI-U trunk daughter card, the design of stand off pillars supplied with all types of trunk daughter card has changed. The original 5 plastic pillars have been replaced by 2 metal pillars and 3 plastic pillars. The metals pillars are pre-fitted to the trunk daughter cards in their intended position and two screws and washers are supplied for final attachment to the base card.

Tools Required.

1. 5mm Flat-blade screwdriver.
2. Anti-static wrist strap and ground point.

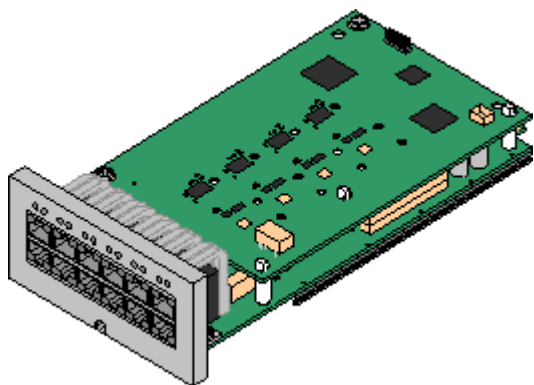

Procedure: Installing an IP500 Trunk Daughter Card

1. Check that correct cards have been supplied.
2. Ensure that you are wearing an anti-static wrist strap connected to a suitable ground point.
3. On the base card identify the position of 3 holes for the plastic pillars for the IP500 card. These are along the same edge as the card connector.
4. Fit the stand off pillars to the IP500 base card.
5. If there is a clip-on metal shield over the connector block on the base card, remove it.
6. Using minimal force and checking that the pins are correctly located, push the IP500 trunk card onto its connector block and the stand off pillars.
7. Check that the card connector has snapped into position.
8. Using the washers and screws provided, secure the metal stand off pillars to the base card.
9. A set of labels are supplied with the trunk daughter card. Fit the appropriate label to the front of the base card.
10. Prepare any other IP500 cards. Then proceed to Inserting an IP500 Card

2. IP400 Legacy Card Installation

An IP500 Legacy Carrier card can be used to fit IP400 trunk or VCM cards into an IP500 control unit. Up to 2 IP500 carrier cards can be inserted.

✓ PRI T1	✓ BRI-8 (UNI)
✓ Dual PRI T1	✓ ANLG 4 Uni (US only)
✓ PRI 30 E1 (1.4)	✓ VCM 4
✓ Dual PRI E1	✓ VCM 8
✓ PRI 30 E1R2 RJ45	✓ VCM 16
✓ Dual PRI E1R2 RJ45	✓ VCM 24
	✓ VCM 30

 **Objective** - To fit a IP400 card to an IP500 Legacy Card Carrier.

 **Warnings**

1. Correct anti-static protection steps should be taken before handling circuit boards.
2. During this process power to the IP Office control unit must be switched off and disconnected.

 **Parts and Equipment Required**

1. IP500 Carrier Card.
2. IP400 Card
The table opposite lists supported cards. Any card not listed is not supported. Cards are supplied with 2 plastic stand off pillars. Trunk cards are also supplied with a replacement blanking plate which are not required with the IP500.

 **Tools Required**

1. 5mm Flat-blade screwdriver.
2. Anti-static wrist strap and ground point.

1. ✓
2. ✓
3. **Procedure: Installing a Carrier Card**

1. Check that correct cards have been supplied.
2. Ensure that you are wearing an anti-static wrist strap connected to a suitable ground point.
3. On the carrier card identify the position of the jumper block and stand off pillar holes for the IP400 card. The peg holes are labeled as VCM or TRUNK.
4. If fitting an IP400 trunk card, identify which of the plastic snap-off panels on the front of the carrier card need to be removed to allow the trunk cable connections. Carefully remove those panels.

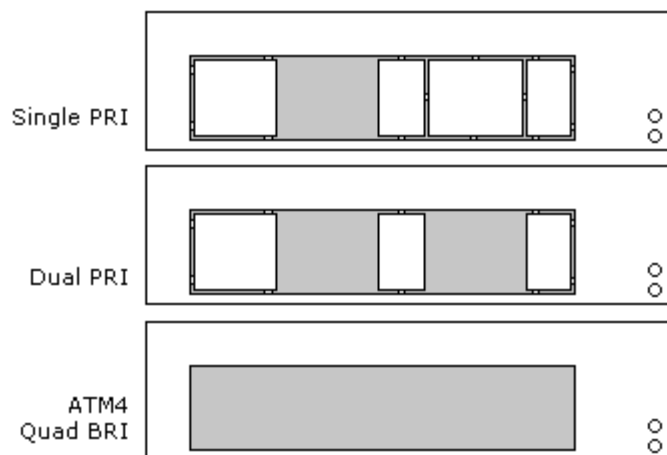
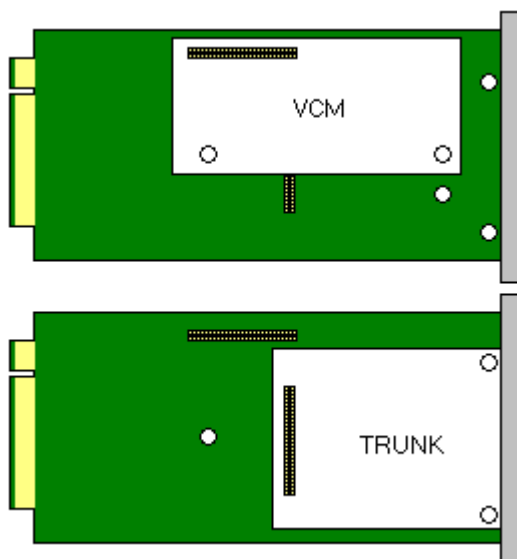
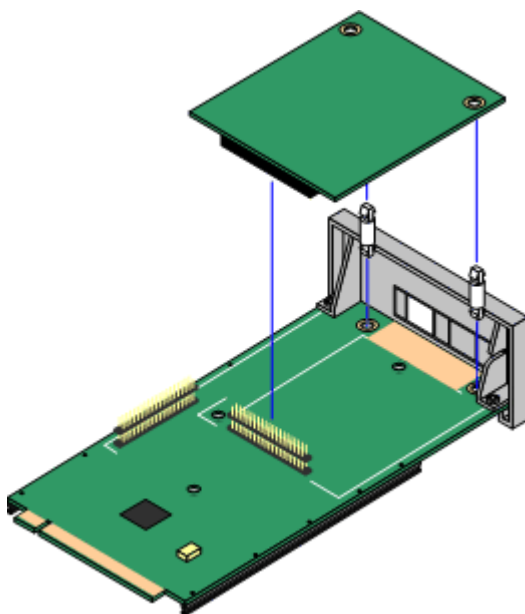

5. Fit the stand off pillars to the IP500 carrier card.
6. Using minimal force and checking that the pins are correctly located, push the IP400 card onto its jumper and the stand off pillars.

D3. IP500 Card Installation

Having prepared each IP500 card by adding any IP400 cards or IP500 trunk daughter cards required, the base cards can be inserted into the control unit.

 **Objective** - To fit a IP500 base card into the IP500 control unit.

 **Warnings**

1. Correct anti-static protection steps should be taken before handling circuit boards.
2. During this process power to the IP Office control unit must be switched off and disconnected.

 **Tools Required.**

1. 5mm Flat-blade screwdriver.
2. Anti-static wrist strap and ground point.

  **Procedure: Installing a Carrier Card**

1. Switch off power to the IP500 control unit.
2. Using a flat-bladed screwdriver, remove the cover from the slot on the front of the control unit that will be used for each card being installed. This cover is no longer required but should be retained until installation has been completed.

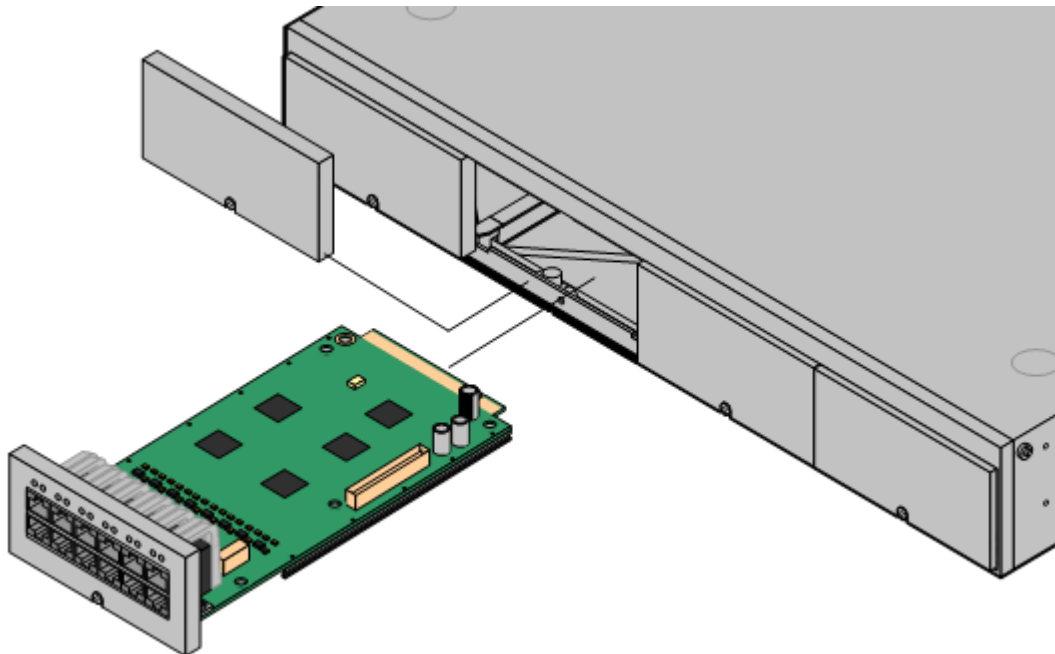

3. Allowing the card to rest against the bottom of the slot, begin sliding it into the control unit. When half inserted, check that the card rails have engaged with the slot edges by trying to gently rotate it. If the card does rotate remove it and begin inserting it again.
4. The card should slide in freely until almost fully inserted. At this point apply pressure at the base of the front of the card to complete insertion.
5. Using a flat-bladed screwdriver secure the carrier card.
6. Reapply power to the control unit. Initially each card should show a red LED (two if a daughter card is fitted) as the control unit restarts. After approximately 30 seconds these should change to flashing red as the card is started. These should then change to flashing every 5 seconds if the cards have started correctly.
7. Run the IP Office System Status Application and verify that the cards have all been recognized.
8. IP Office Manager can now be used to configure the extensions and trunk lines. For any IP500 VCM base cards, VCM Channel licenses must be added to the configuration to enable channels above the base 4.

7.5 Inserting the Feature Key

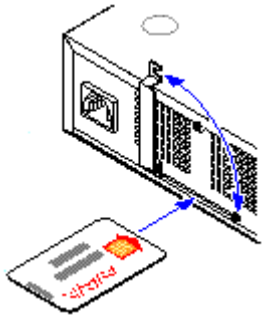

The IP500 uses a smart card feature key dongle. In addition to feature licensing the IP500 control unit uses this feature key dongle to determine various systems defaults such as A-Law or Mu-Law operation, default short codes and trunk settings.

⚠ Warnings

1. The feature key is required for all IP500 control units and must be present when the system is started and during operation. This applies even if the IP500 is not using any licensed features.
2. The feature key slot cover must remain present to protect the card and the card reader from damage.
3. Correct anti-static protection steps should be taken before handling circuit boards.
4. During this process power to the IP Office control unit must be switched off and disconnected.

📦 Parts Required

• IP500 Feature Key

The correct key will depend on the locale. The listing below is typical and may not apply in all cases. Ensure that the serial number of the key, shown on the card, is recorded.

- **Mu-Law:** Used in North America and Korea.
- **A-Law:** Used in all other locales.



Tools Required:

1. 5mm Flat-blade screwdriver.

1. Procedure

1. Locate the feature key slot on the rear of the IP500 control unit. The slot is adjacent to the power input socket and is protected by a metal cover.
2. Undo the screws on the cover until it can be rotated clear of the feature key card slot.

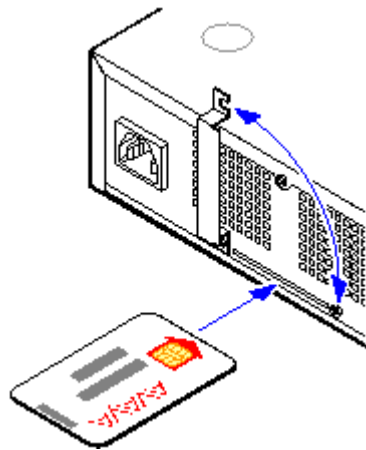

3. Insert the feature key. The card should be face up and inserted in the direction of the arrow on the card.
4. Rotate the slot cover back into position and tighten the screws.

7.6 Applying Power

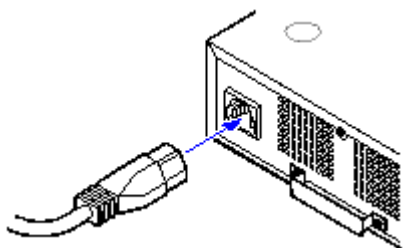

This procedure starts a new IP Office control unit not connected to any LAN. In this scenario the IP Office control unit will assume its default configuration settings.

Objective - To power up the IP Office control unit to a known state with a known set of defaults.

Warnings

1. When powering up the control unit for the first time do not connect the LAN or WAN ports of the control unit to any network.
2. The power cord must be connected directly from the control unit to the switched power outlet socket. The cord must not be fixed in anyway or routed through any permanent structure.

Parts and Equipment Required

1. Switched power outlet socket.
2. IP Office Control Unit.
3. Locale Specific Power Cord.

Procedure

1. Connect the power cord from the power supply outlet to the power input socket on the rear of the control unit.
 - Power cords must not be attached to the building surface or run through walls, ceilings, floors and similar openings. Installation measures must be taken to prevent physical damage to the power supply cord, including proper routing of the power supply cord and provision of a socket outlet near the fixed equipment or positioning of the equipment near a socket outlet.
2. Switch on power to the control unit.
3. New IP Office 500 control units are supplied with a base software level of 4.0.0. The CPU LED on these units will flash red until the unit is upgraded to the required level of released IP Office core software.
4. The CPU LED on units that have already been upgraded from 4.0.0 will go through a green red cycle several times and then stay green on. During this time other LED's may flash as the unit goes through its power on self test cycle.

IP Office Default Settings

The following are the basic default configuration settings for an IP Office system.

System	Name	MAC address of the control unit.	
	System Password	password	
	License Server IP Address	255.255.255.255	
LAN*		LAN1	LAN2/WAN
	IP address	192.168.42.1.	192.168.43.1
	IP Mask	255.255.255.0	255.255.255.0
	DHCP Mode	Server	Server
	No of DHCP IP Addresses	200.	200.

*See **Default DHCP/Data Settings** detail below.

• **Extensions and Users**

A user is automatically created for each physical extension port detected in the system. Users are assigned extension numbers starting from 201. User names take the form Extn201, Extn202,

• **Hunt Group**

A single hunt group 200 called Main is created and the first 10 users are placed into that hunt group as members.

• **Incoming Call Routes**

Two default incoming call routes are created. Voice calls are routed to the hunt group Main. Data calls are routed to the RAS user DialIn.

- **Default Short Codes**

IP400 control units are manufactured as either A-Law or U-Law variants. For IP500 control units, A-Law or U-Law variant operation is determined by the IP500 Smart Card installed. Depending on the variant, different sets of short codes are created for the default configuration. Refer to the IP Office Manager application help for full details.

- **Default DHCP/Data Settings**

When a defaulted IP Office control unit is switched on, it requests IP address information from a DHCP Server on the network. This operation will occur whether the LAN cable is plugged in or not.

- If a DHCP server responds within approximately 10 seconds, the control unit defaults to being a DHCP client and uses the IP address information supplied by the DHCP server.
- If no DHCP Server responds, the control unit defaults to being the DHCP server for the LAN using the following settings:
 - For its LAN1 it allocates the IP address 192.168.42.1 and IP Mask 255.255.255.0. It supports 200 DHCP clients using the addresses range 192.168.42.2 and 192.168.42.201, the IP Mask 255.255.255.0 and default gateway address 192.168.42.1 (the Control Unit's LAN1 address).
 - For its LAN2 if supported, it allocates the IP address 192.168.43.1 and IP Mask 255.255.255.0.
 - Note that the IP Office does not check that these addresses are valid and or available on the network.
- This mode of operation will persist for subsequent power ups, until a config save occurs due to one of the following
 - The unit performs its automatic midnight backup.
 - A configuration is merged using IP Office Manager.
 - A soft reboot is performed using IP Office Manager.
 - A software upgrade is performed.

7.7 Installing the Admin Applications



This procedure covers installation of applications in the IP Office Admin suite.

Objective - To install the applications necessary for the installation and maintenance of an IP Office system.

Information Required

- Which IP Office Admin Suite applications are being installed?
The following list indicates those that are required for installation and configuration:

- System Monitor - Install** ✓
Monitor is a tool intended primarily for Avaya technicians and engineers. However it is able to report on all aspects of IP Office operation and is therefore an important tool for diagnostics.
- Feature Key Server - Not required.** ✗
The Feature Key Server should only be installed if the PC will host the parallel port or USB port Feature Key dongle for the IP Office system.
- Manager - Install** ✓
This application is required to edit and manage the software on the IP Office system.
- Voicemail Mail Lite - Optional**
Only install this application if no other voicemail system, for example Voicemail Pro or embedded voicemail, is being installed. Note also that IP Office Lite is not supported by IP500 systems running in IP Office Standard Edition mode.
- System Status Application - Install** ✓
This application is used with IP Office 4.0 systems to show equipment and resource within the system, alarms and calls in progress.
- Previous System Monitor - Not required.** ✗
This application is only required for supporting IP400 systems running pre-IP Office 4.0 software. It is not required for IP500 control units.
- Call Status - Not required.** ✗
This application is only supported for pre-4.0 IP Office systems. For IP Office 4.0 and higher it has been replaced by the System Status Application above.

Parts Required

1. IP Office Administrator Applications CD.

2. Windows PC

This should meet the requirements of the administrator applications being installed. If a server PC from the customer installation is available, for example for Voicemail Pro, use that PC. The specification below is just for IP Office Manager. If other applications are to be installed on the PC then their requirements should also be met.

Requirement	Minimum	Recommended
Processor	600MHz Pentium or AMD Opteron, AMD Athlon64, AMD Athlon XP.	800MHz Pentium or AMD Opteron, AMD Athlon64, AMD Athlon XP.
RAM	128MB	256MB
HD Space	1GB - 800MB for .NET2, 200MB for Manager.	1.4GB - 800MB for .NET2, 600MB for the full IP Office Admin suite.
Display	800 x 600 - 256 Colors	1024 x 768 - 16-bit High Color
Operating System	Windows XP Professional with SP2. Windows 2000 Server with SP4. Windows 2003 Server. Windows 2003 SBS. Note: 64-bit versions of the operating systems above are not supported.	

Procedure: Installing the IP Office Admin Applications

1. Using the **Add or Remove Programs** option in the Windows Control Panel, check that the PC does not already have a version of the IP Office Admin suite installed.
 - If 'yes' and the suite is a pre-IP Office 3.2 version, remove the existing IP Office Admin suite via Add/Remove Programs.
 - If the existing suite is IP Office 3.2 or higher, it is possible to upgrade without removing the previous installation.
2. Insert the IP Office Administrator Applications CD. The installation process should auto start. If it does not auto start, open the CD contents and double-click setup.exe.
3. Select the language you want to use for the installation process. This does not affect the language used by Manager which will attempt to match your Windows regional setting. Click **Next >**.
4. Select whether only the current Windows logon account should be able to run the Admin Suite applications or whether they will be available to all users of the PC. Click **Next >**.
 - The previous selection does not affect the IP Office Feature key server application, if installed. That application runs as a service whenever the PC is running.
5. If required select the destination to which the applications should be installed. We recommend that you accept the default destination. Click **Next >**.
6. The next screen is used to select which applications in the suite should be installed. Clicking on each will display a description of the application. Click on the ▼ next to each application to change the installation selection. When you have selected the installations required, click **Next >**.

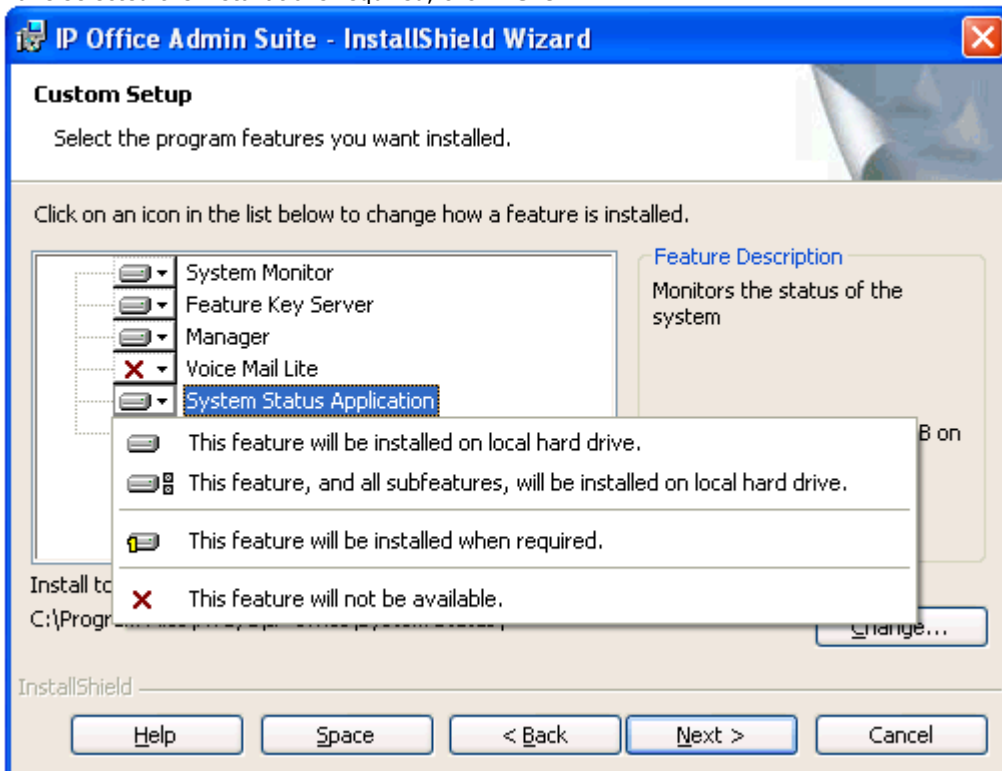

- For IP Office system installations, ensure that at minimum System Monitor and Manager are selected.
 - Only select Voice Mail Lite if this PC will also be the customer's Voicemail Lite server PC.
 - Deselect Feature Key Server unless this PC will be hosting a Parallel port or USB port Feature Key dongle for the customer's IP Office system.
7. Click **Install**.
 8. Installation of Windows .Net2 components may be required. If dialogs for this appear, follow the prompts to install .Net.
 9. If requested, reboot the PC.

7.8 Connecting the Manager PC (IP500)

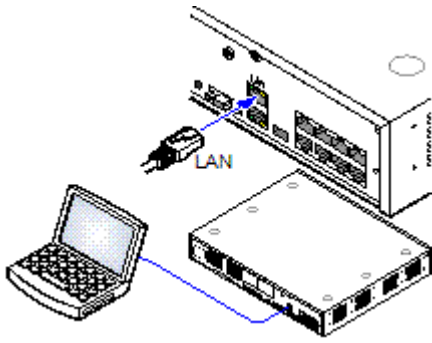

At this stage we will directly connect the Manager PC to the new IP Office control unit. For this the PC will need to be set to a fixed IP address in the same subnet range as the IP Office control unit's default address (192.168.42.1/255.255.255.0).

 **Objective** - Physically connecting the Manager PC and the IP Office without needing to adjust or configure any intervening equipment.

Parts and Equipment Required

1. Manager PC.
2. LAN Cable.
- IP Office Small Office Edition, IP406 V2 and IP500 control units: A standard RJ45-RJ45 LAN cable can be used.
- IP412 Control Unit: A RJ45-RJ45 cross-over LAN cable is required.

1. 
2. 

Procedure: Direct Connection to a Defaulted IP Office Control Unit

1. Check that the TCP/IP properties for the Manager PC's Local Area Network connection are set as follow:
 - Fixed IP address: 192.168.42.203
 - Subnet mask: 255.255.255.0
 - Default gateway: 192.168.42.1.
2. Connect the LAN cable from the PC's LAN port the LAN 1 port on the IP Office control unit.
3. Check that the orange LED lamp on the IP Office LAN port is on. The green LED may also be flickering as it indicates traffic across the LAN connection.
4. Select **Start | Run** and enter **cmd**.
5. In the command window that appears enter ping **192.168.42.1**. The results should show a number of ping replies from the IP Office. This confirms basic communication between the Manager PC and the IP Office.
6. If there are no ping replies enter **ipconfig**. The results should list the IP address settings of the Manager PC as required above and with no mention of DHCP being used. Enter exit.
7. Check the cable connection.

7.9 Start Manager

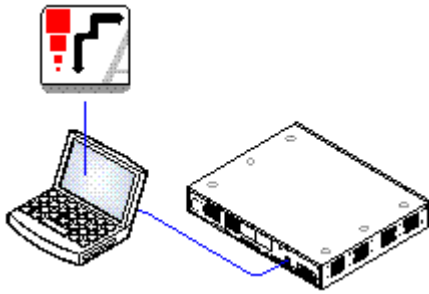

At this stage we will simple check that Manager is able to run and to see the connected IP Office control unit.

1.

Procedure: Receiving the Configuration

1. Select **Start | Programs | IP Office | Manager**.
2. If the PC has firewall software installed, you should be prompted as to whether you want to allow this program to access the network. Select **Yes** or **OK**.
3. Click in the main toolbar or select **File | Open Configuration** from the menu bar.
4. The Select IP Office window appears. After a few seconds it should list the control unit that is being setup. The default name used is the control units MAC address.
 - If the system required was not found, the address used for the search can be changed. Enter or select the required address in the Unit/Broadcast Address field and then click Refresh to perform a new search.
5. Click the check the box next to the system and then click OK.
6. The name and password request is displayed. The name and password must match one of those setup through the security settings. The default name and password for full configuration settings access is Administrator and Administrator.
7. Successful receiving of the configuration is shown by the full configuration tree being shown in the left-hand panel. With no configuration loaded the navigation pane shows just BOOTP and Operator entries.

7.10 Upgrading the Core Software



New IP500 control units are supplied with a basic level of software (4.0.0). That software is sufficient to allow LAN network connect to the control unit in order to then upgrade it to the level of IP Office software required.

 **Objective** - Upgrade the control unit to IP Office 4.0 software.

 **Information Required**

1. **System Password** - For a new or defaulted system this is password.

 **Tools Required**

1. **Manager PC** - The Upgrade Wizard tool is part of the Manager application.

WARNINGS

• **Check IP Office Technical Bulletins**

Check the latest IP Office Technical Bulletin for the IP Office software release before proceeding any further. It may contain information relating to changes that occurred after this document was completed. Bulletins are available from <http://support.avaya.com>.

• **Multiple Managers**

If more than one copy of Manager is running it is possible for the IP Office to request BIN files from a different Manager from the one that started the upgrade process. Ensure that only one copy of Manager is running when upgrading an IP Office system.

Procedure: Upgrade Procedure

1. Using Manager, click  and receive the configuration from the IP Office. If not already done this action creates a BOOTP entry in Manager for the IP Office system. This action also confirms communication between the Manager PC and the IP Office.
2. Select **File | Save Configuration As...** and save a copy of the configuration file onto the PC. This action should be completed before upgrading any IP Office system.
3. Select **File | Advanced | Upgrade**.
4. The UpgradeWiz is started and scans for IP Office unit using the Unit/Broadcast address. Adjust this address and click Refresh if the expected modules are not shown.
5. For each the unit found, the UpgradeWiz displays the module type, its current version of software installed in the unit and the software version of the .bin file that Manager has available.
6. For those units and modules where manager detects that it has a higher version available, the tick box next to the unit or module is automatically selected.
7. For those modules which you want to upgrade, tick the check box. For modules where a later version of software is available the check box may have already been automatically ticked.
8. Select **Upgrade**.
9. The system password will be requested. Enter it and click **OK**.
10. The bin files required are transferred to the system and stored in temporary memory.
11. Once all the files have been transferred, the upgrade wizard will prompt whether it okay to proceed with the upgrade process. Select Yes to continue.
12. Each module being upgraded will delete its existing core software, restart and load the new software file that was transferred. This process may take several minutes for each unit. Do not cancel or close the upgrade wizard while this process is running.
13. Following the upgrade check that the upgrade wizard now shows that the selected units and modules have upgraded. It may be necessary to select Refresh to update the information in the upgrade wizard display.

7.11 Check the CPU LED

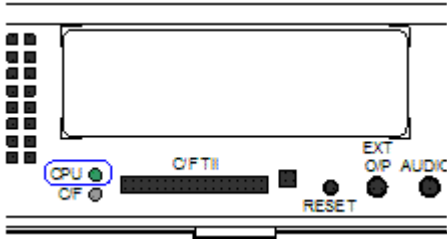

During normal operation, the CPU LED on the rear of the IP500 control unit should be green.

- **Note**

New IP Office 500 control units are supplied with a base software level of 4.0.0. The CPU LED on these units will flash red until the unit is upgraded to the required level of released IP Office core software.

Normal Power On Sequence

When power to the control unit is switched on, the normal sequence for the CPU LED is as follows.

1. Steady Red for 3 seconds
2. Off for 10 seconds
3. Flashing alternate red/green for 4 seconds

4. Steady Green

The LED should be steady green following successful start up. Note that the IP500 cards on the front of the control unit may still be going through their own start up process.

- **Flashing RED**

A flashing red CPU LED at this stage indicates an error. The most likely cause is a missing Feature Key card.

7.12 Check the Card LEDs

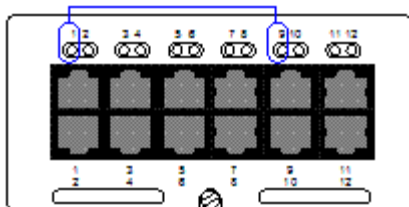

On all IP500 base cards, LED 1 is used to indicate general status. Okay status is indicated by a flash every 5 seconds.

When a trunk daughter card is fitted, LED is used to indicate the general status of that card. Okay status is indicated by a flash every 5 seconds.

IP500 Analog Phone Base Card

Analog Extension Ports (1-8)

LED1 only is used.

LED1 is used for card status:

Red On - Error

Red Flashing - Initializing.

Red Flash every 5 seconds - Okay.

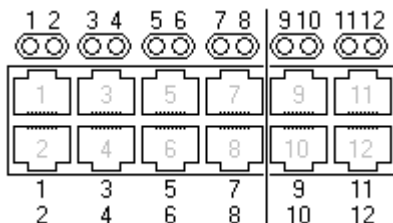

IP500 Digital Station Base Card

Digital Station Ports (1-8)

Green On - Phone detected.

LED1 is used for card status:

Red On - Error

Red Flashing - Initializing.

Red Flash every 5 seconds - Okay.



IP500 VCM Base Card

- LEDs 1 to 8 are unlabelled. They are used to indicate voice compression channel usage. Each LED lit represents 12.5% of the available voice compression channel capacity in use (total card capacity rather than licensed capacity).
- LED1 is used for general card status. Flash every 5 seconds = Okay.

IP500 Trunk Daughter Cards

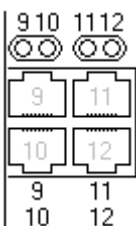

Daughter Card Ports (9-12)

The LED's for ports 9 and 10 are used as follows:

- Off: No trunk present/Analog - Idle.
- Green on: BRI/PRO trunk present.
- Green flashing: Trunk in use.
- Red/Green Fast Flash (port 9) or Green Fast Flash (port 10): Alarm indication signal (AIS) from the PRI trunk remote end.
- Red with Green Blink (port 9) or Green Blink (port 10): PRI Port in loopback mode (set through IP Office System Monitor).
- LED 9 is also used for daughter card status. Flash every 5 seconds = Okay.

7.13 Receiving the Configuration



The process here applies to systems running IP Office 3.2 and higher.

Objective - Receive a configuration from an IP Office running IP Office 3.2 or higher software.

Information Required

1. Service User Name and Password
The defaults for full configuration access are Administrator and Administrator. However these should have been changed as part of the installation process, see [Configuring Security Settings](#).

1.

Procedure: Receiving the Configuration

1. Select **Start | Programs | IP Office | Manager**.
2. Click in the main toolbar or select **File | Open Configuration** from the menu bar.
3. The Select IP Office window appears. After a few seconds it should list the control unit that is being setup. The default name used is the control units MAC address.
 - If the system required was not found, the address used for the search can be changed. Enter or select the required address in the Unit/Broadcast Address field and then click Refresh to perform a new search.
4. Click the check the box next to the system and then click **OK**.
5. The name and password request is displayed. The name and password must match one of those setup through the security settings. The default name and password for full configuration settings access is Administrator and Administrator.
6. Successful receiving of the configuration is shown by the full configuration tree being shown in the left-hand panel. With no configuration loaded the navigation pane shows just BOOTP and Operator entries.

IP Office Default Settings

The following are the basic default configuration settings for an IP Office system.

System	Name	MAC address of the control unit.	
	System Password	password	
	License Server IP Address	255.255.255.255	
LAN1		LAN1	LAN2/WAN
	IP address	192.168.42.1.	192.168.43.1
	IP Mask	255.255.255.0	255.255.255.0
	DHCP Mode	Server	Server
	No of DHCP IP Addresses	200.	200.

- **Extensions and Users**

A user is automatically created for each physical extension port detected in the system. Users are assigned extension numbers starting from 201. User names take the form Extn201, Extn202,

- **Hunt Group**

A single hunt group 200 called Main is created and the first 10 users are placed into that hunt group as members.

- **Incoming Call Routes**

Two default incoming call routes are created. Voice calls are routed to the hunt group Main. Data calls are routed to the RAS user DialIn.

7.14 Adding Licences



32-Character license keys strings are used to activate various IP Office features. These keys are uniquely based on the feature being activated and the serial number of the Feature Key dongle installed with the IP Office system.

The IP500 uses licenses in the same way as other IP Office systems. However there are some licenses that are specific to the IP500 Office control unit and may be required during installation to ensure the systems correct operation.

- **IP Office Upgrade Standard to Professional**

By default the IP500 runs in IP Office Standard Edition mode. For full IP Office operation an IP Office Upgrade Standard to Professional license must be added to the configuration.

- **IP500 Voice Networking**

If IP trunks are required for voice networking between the IP Office and other systems, IP500 Standard Networking licenses are required. This type of license is available as a base license for the first 4 channels and then additional licenses for any additional channels required.

- **VCM Channels**

Each IP500 VCM base card only support 4 voice compression channels unlicensed. Any additional channels available on the card must be licensed by adding IP500 VCM Channels licenses

Licenses can be added individually to the IP Office's configuration. However the licence key file provided by Avaya from their license ordering web site generates a License.csv file containing all the ordered licenses. That file can be imported into the configuration.



Parts and Equipment Required

1. License Keys Documentation

Ensure that the Feature Key dongle serial number used to generate the license keys matches that of the Feature Key dongle installed and that all the licenses required have been included.





2. Importing a License.csv File

1. Copy the License.csv file to the Manager PC.
2. Start Manager and receive the IP Office system's configuration.
3. Select **File | Import/Export | Import...**
4. Click the button next to Look In and browse to and select the folder containing the license file.
5. The file should be listed as Available along with an indication of the number of licenses it contains. Select the check box next to the file name and then click OK.
6. Click on  to send the configuration back to the IP Office.
7. Use Manager to receive the configuration again and check that the status of the licenses. They should now be Valid.



3. Manually Adding Licenses

Use this process to individually copy and paste license keys into the configuration. Cutting and pasting removes any errors that may be caused by the incorrect typing of any license key.

1. Start Manager and receive the IP Office system's configuration.
2. Select  **License**.
3. To add a license, click  and select **License**. Enter the new license and click **OK**.
4. The **Status** of the new license should show **Unknown** and name the license as expected. If its **Status** is **Unknown** and name **Invalid**, the most likely cause is incorrect entry of the license key characters.
5. Repeat the process for any other licences
6. Click on  to send the configuration back to the IP Office.
7. Use Manager to receive the configuration again and check that the status of the licenses. They should now be **Valid**.

7.15 Adding External Expansion Modules

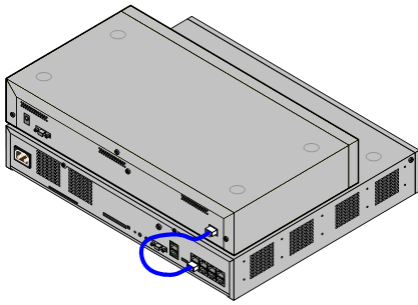

External expansion modules connect to the IP Office control unit using a blue 1 meter (3'3") expansion interconnect cable supplied with the modules.

 Objective - Connect the external expansion modules and then restart the control unit so that the new modules are recognized.

Each module is supplied with an expansion connect cable and a [power supply unit](#). An appropriate [locale specific power cord](#) for the power supply unit, and [cables](#) for the ports on the front of the module must be ordered separately.

Warnings

1. No cable other than an Expansion Interconnect cable should be used. Use of any alternate cable will lead to system failure.
2. External expansion modules are not supported by an IP500 control unit running in Express Edition mode.

Installation Requirements

1. Installation space either on or under the existing IP Office control unit.
2. Switched power outlet socket.
3. Free EXPANSION port on the rear of the control unit.
4. The control unit must have a valid IP500 Upgrade Standard to Professional license.
5. Grounding Requirements
 - 5.1. **Functional Grounding**
Connection of a [functional ground](#) is:
 - Recommend for all modules.
 - Connection of a functional ground is mandatory for Analog Trunk module.
 - 5.2. **Protective Grounding**
Connections of a protective ground via [surge protection equipment](#) is:
 - Mandatory for Analog trunk modules in the Republic of South Africa.
 - Mandatory for Digital Station and Phone modules connected to out of building extensions.
 - Mandatory for Digital Station V2 and Phone V2 modules.

Tools Required

1. Manager PC.
2. [Tools for rack mounting](#) (optional).

Parts and Equipment Required

1. External Expansion Module.
Each module is supplied with a suitable external power supply unit and a RJ45-RJ45 expansion interconnect cable.
2. [Power cord for the power supply unit](#).
3. [Rack mounting kit](#) (optional).
4. Cable labelling tags.

Procedure

1. Switch off power to the IP Office control unit.
2. Attach the external expansion module's power supply.
3. Connect the blue expansion interconnect cable from the module's EXPANSION port to the first free EXPANSION port on the control unit.

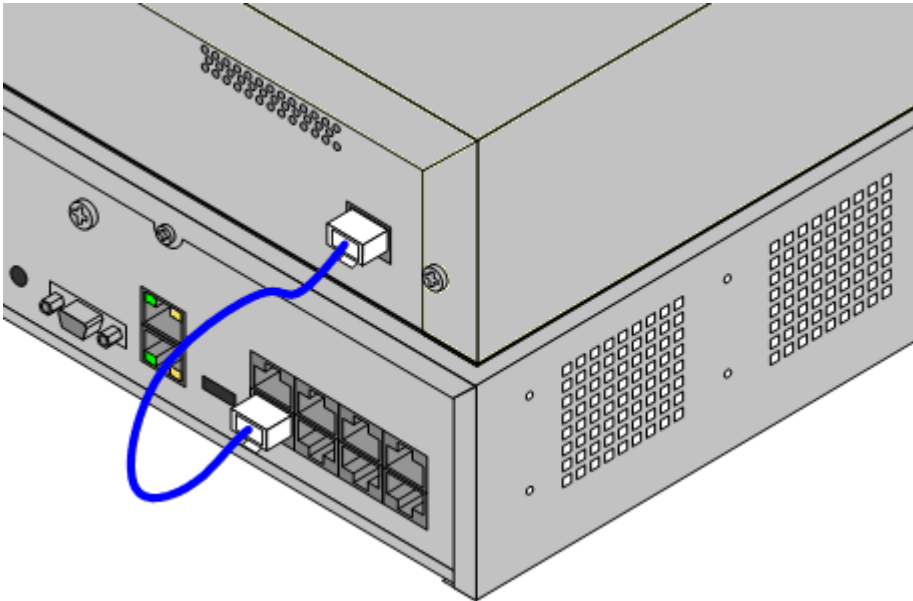

4. Make careful note of the port used and include this detail on the cable label and any other system records.
5. Switch on power to the module. Wait for the center LED on the front of the module to change from red to green.
6. Switch on power to the control unit.
7. Once the control unit has rebooted, using Manager receive the system configuration.
8. Click on  **Unit** in the left-hand panel.
9. Check that the list of units shown in the right-hand panel is correct.
10. The external expansion modules should be upgraded to the same level of software as the control unit. Do this by repeating the IP Office upgrade process (see [K. Upgrading the Core Software](#)).

7.16 Configuring Security Settings



Currently the system is defaulted, including the security passwords controlling access to the system's security and configuration settings.







You should read and understand the **Security Settings** section of the IP Office Manager documentation. That section details the settings and operation of the IP Office security settings and is part of the Manager applications help file.



Objective - Make the control unit configuration settings secure from unauthorized changes by changing the default passwords.

1.
2.
3.

Procedure

1. Select **Start | Programs | IP Office | Manager**.
2. Select **File | Advanced | Security Settings**.
3. The **Select IP Office** window appears. After a few seconds it should list the control unit that is being setup. The default name used is the control unit's MAC address.
 - If the system required was not found, the address used for the search can be changed. Enter or select the required address in the Unit/Broadcast Address field and then click Refresh to perform a new search.
4. Click the check the box next to the system and then click OK.
5. The name and password request is displayed. As the system has been upgrade to IP Office 3.2 software, the name and password now requested are a Service User name and password stored within the IP Office. The default name and password for security settings access are security and securitypwd.
6. The Manager should load and display the IP Office control unit's security settings.
7. Select  **General**. On the tab displayed, the Security Administrator section contains the default name and password used to access the IP Office's security settings. Click Change and set a new password. The default password is securitypwd. Click OK.
8. Click **OK** to save the changes to that tab.
9. Select  **Rights Groups** and then the **Administrator Group**.
10. Select the **System Status** tab and check that **System Status Access** is selected. This is required for the System Status Application.
11. Click **OK** to save the changes to that tab.
12. Select  **Service Users**. This tab shows the settings for one of the Service Users who have names and passwords used for access to the configuration settings on the IP Office control unit. Click **Change** and set a new password. The default password matches the name. Click **OK**.
13. Click **OK** to save the changes made on that tab.
14. Click **>** button to display the settings for the next Service User and repeat the process in the previous two steps to change their password.
15. Click **OK**.
16. The new security settings can now be sent to the IP Office control unit. Click .
17. The original name and password used to load the settings will be requested. Enter the details and click OK.

7.17 Rack Mounting

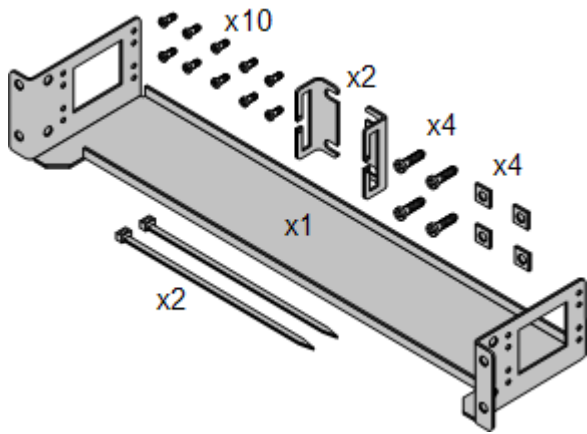

The IP500 control unit and IP500 external expansion units can be rack mounted if required into 19-inch rack systems. This requires an IP500 Rack Mounting Kit (SAP 700429202) for each unit.

The kit includes:

- A rack mounting bracket and screws for attachment of the bracket to the unit
- Nuts and bolts for rack attachment.
- Brackets and cable ties for cable tidying.

As indicated in the diagram following, the rack mounting bracket can be used in several positions on the unit. IP400 external expansion units used in an IP500 system can also be rack mounted but use a separate IP400 Rack Mounting Kit.

Environmental Requirements

In addition to the existing [environmental requirements](#) for an IP Office system, the following additional factors must be considered when rack mounting a unit:

1. Rack Positioning - Ensure compliance with the rack manufacturers safety instructions. For example check that the rack legs have been lowered and fixing brackets have been used to stop toppling.
2. Elevated Operating Ambient - If installed in a closed or multi-unit rack assembly, the operating ambient temperature of the rack environment may be greater than room ambient. Therefore, consideration should be given to installing the equipment in an environment compatible with the maximum ambient temperature (T_{ma}) specified by the manufacturer.
 - Operating Temperature: 0°C (32°F) to 40°C (104°F).
 - Operating Humidity: 10% to 95% non-condensing.
3. Reduced Air Flow - Installation of the equipment in a rack should be such that the amount of air flow required for safe operation of the equipment is not compromised. Proper ventilation must be maintained. The side ventilation slots on the IP500 control unit should not be covered or blocked.
4. Mechanical Loading - Mounting of the equipment in the rack should be such that a hazardous condition is not achieved due to uneven mechanical loading.
5. Circuit Overloading - Consideration should be given to the connection of the equipment to the supply circuit and the effect that overloading of the circuits might have on overcurrent protection and supply wiring. Appropriate consideration of equipment nameplate ratings should be used when addressing this concern.
6. Reliable Earthing - Reliable earthing of rack-mounted equipment should be maintained. Particular attention should be given to supply connections other than direct connections to the branch circuit (e.g. use of power strips).
7.  Only the screws (M3 x 6mm) provided with the mounting kit should used to attach the brackets to the control unit.

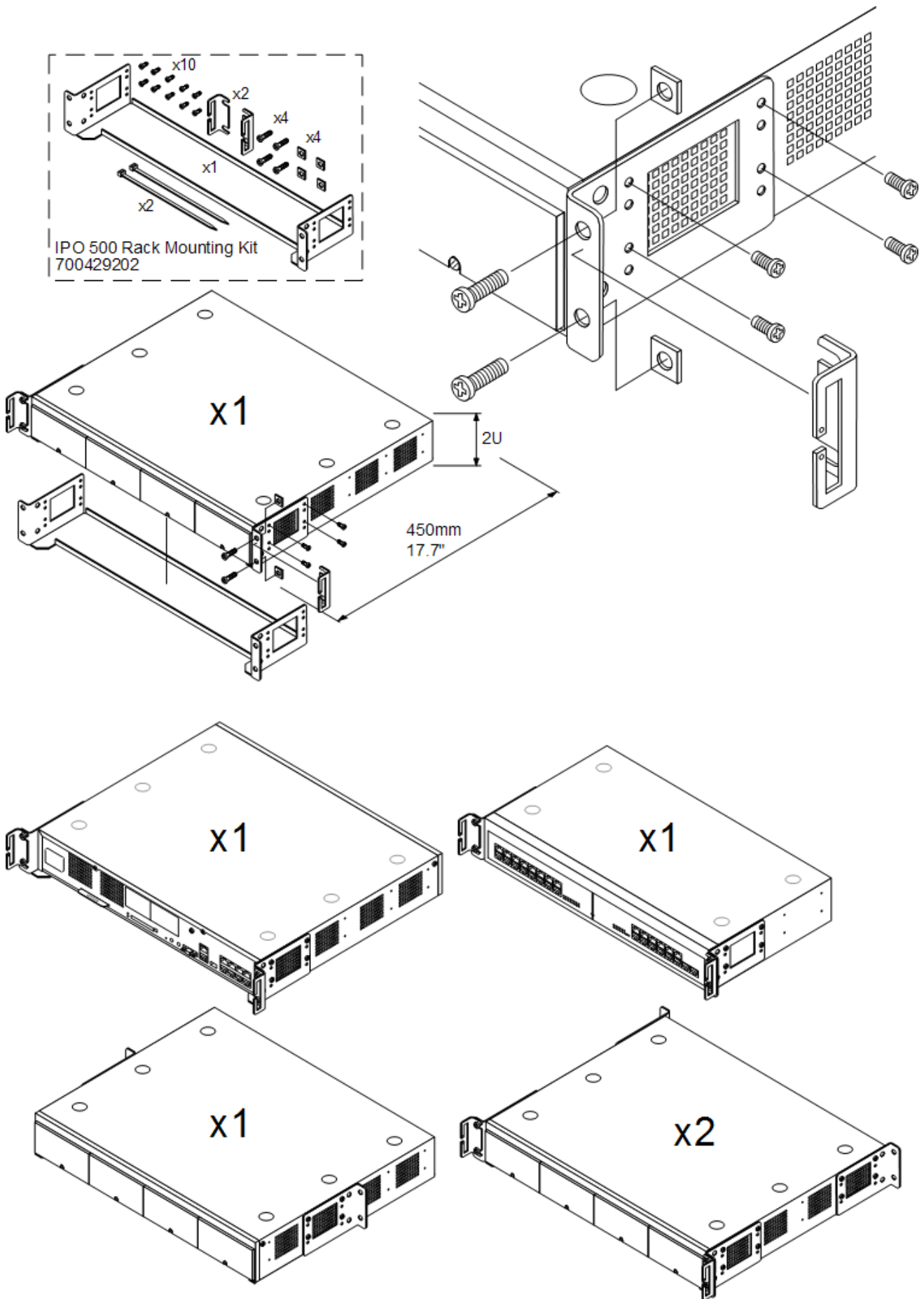

-
-  Only the screws (M3 x 6mm) provided with the mounting kit should be used to attach the brackets to the control unit.



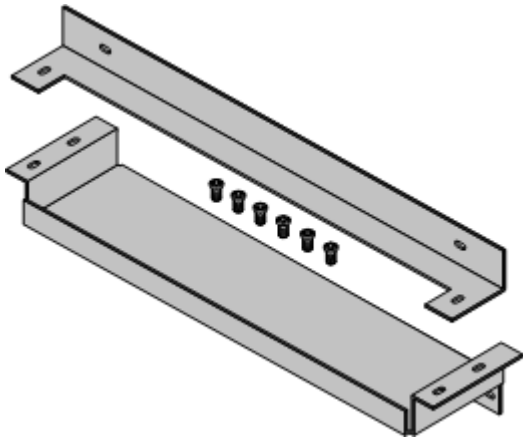

7.18 Wall Mounting



The IP500 control unit can be wall mounted. This requires an IP500 Wall Mounting Kit (SAP 700430150) plus additional 4.5mm fixtures and fittings suitable for the wall type. The wall mounting kit includes two brackets, one top and one bottom.

Environmental Requirements

In addition to the existing [environmental requirements](#) for an IP Office system, the following additional requirements apply when wall mounting a unit:

-  The wall surface must be vertical, flat and vibration free.
-  A minimum clearance of 500mm (19.7 inches) is required on all sides.
-  The unit must be orientated as shown when mounted. That is with the base card slots facing right when viewed from in front of the unit.
-  The brackets must be used as shown, with the deeper tray-like bracket used at the bottom of the wall mounted control unit.
-  Only the screws (M3 x 6mm) provided with the mounting kit should be used to attach the brackets to the control unit.

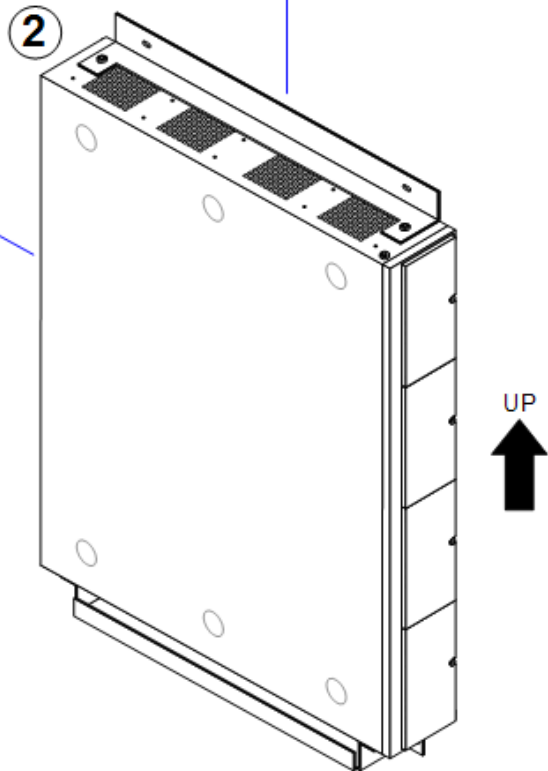
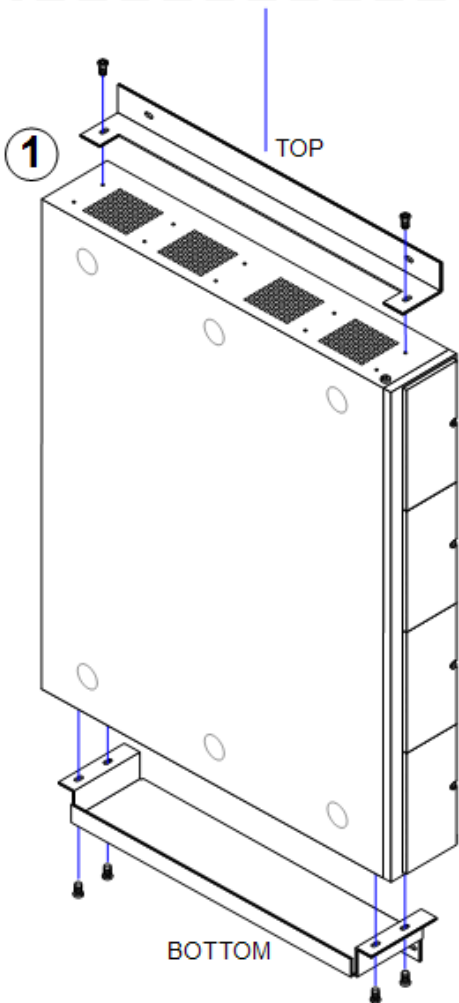
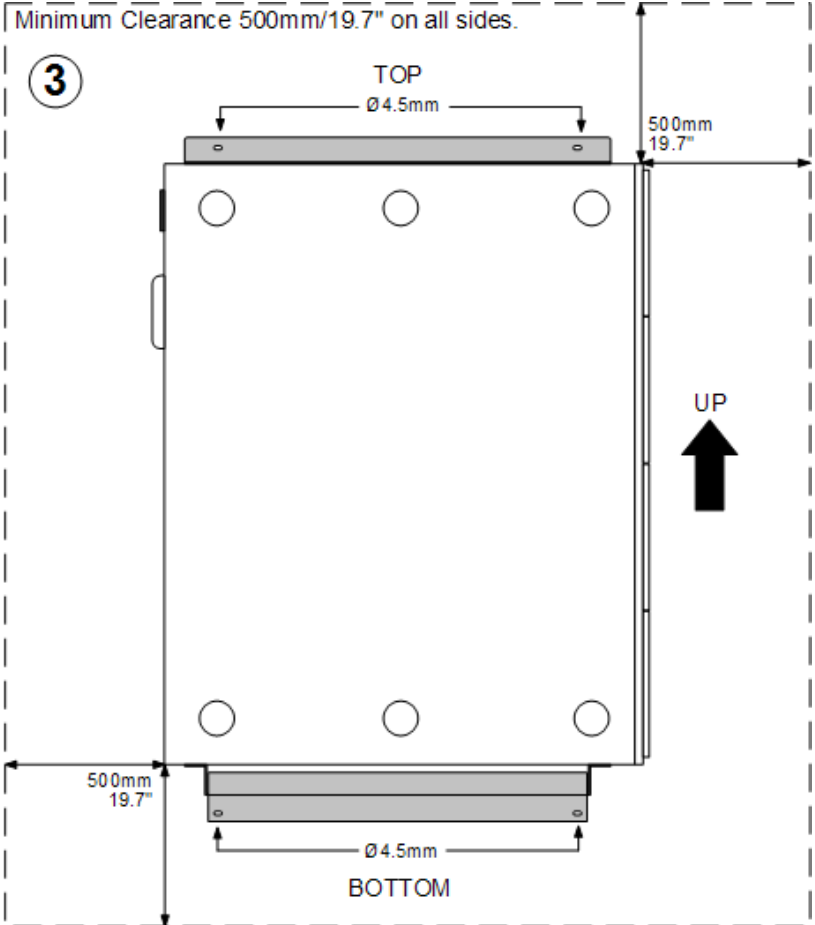
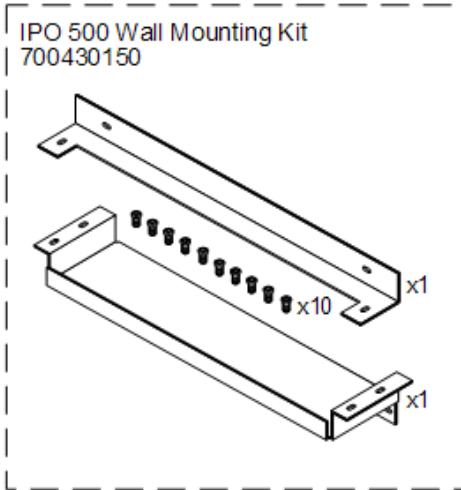

- Fix to solid vertical surface using wall fixings suitable for the wall type.
- Orientation must be as shown.
- A minimum clearance of 500mm/19.7" is required on all sides.

- The brackets must be used as shown, with the deeper tray-like bracket used at the bottom of the wall mounted control unit.
- Only the screws (M3 x 6mm) provided with the mounting kit should be used to attach the brackets to the control unit.



7.19 Grounding

Use of ground connections reduces the likelihood of problems in most telephony and data systems. This is especially important in buildings where multiple items of equipment are interconnected using long cable runs, for example phone and data networks.

All IP Office control units and external expansion modules must be connected to a functional ground. In some cases, such as ground start trunks, in addition to being a protective measure this is a functional requirement for the equipment to operate. In other cases it may be a locale regulatory requirement and or a necessary protective step, for example areas of high lightning risk.

-  **WARNING**

During installation do not assume that ground points are correctly connected to ground. Test ground points before relying on them to ground connected equipment.

The ground point on IP Office control units and external expansion modules are marked with a  or  symbol. [Ground](#) connections to these points should use a 14 AWG solid wire with either a green sleeve for a functional ground or green and yellow sleeve for a protective ground.

- **Additional protective equipment**

In addition to grounding, additional protective equipment will be required in the following situations. Refer to "[Out of Building Telephone Installations](#)".

- On any Digital Station or Phones external expansion module connected to an extension located in another building.
- In the Republic of South Africa, on all Analog Trunk external expansion modules (ATM16) and on any control units containing an analog trunk cards (ATM4/ATM4U).



Tools Required



1. M4 Cross-Head Screwdriver.
2. Tools suitable for crimping a cable spade.



Parts and Equipment Required

1. 14AWG Solid copper wire for ground connection.
2. Cable sleeve matching local regulator requirements. Typically green for a functional ground and green/yellow for a protective ground.

Procedure

The ground point on IP Office control units and expansion modules are marked with a  or  symbol. [Ground](#) connections to these points should use a 14 AWG solid wire with either a green sleeve for a functional ground or green and yellow sleeve for a protective ground.

IP500 Control Unit

On IP500 control units the ground point is located above the RS232 DTE port.

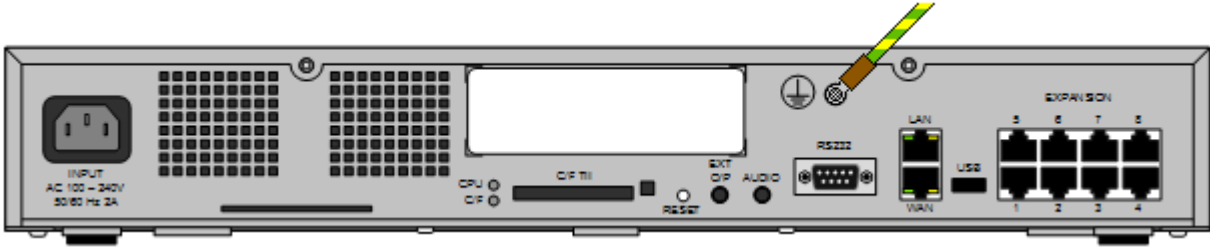

External Expansion Modules

On expansion modules, the ground point is a 4mm screw located towards the right on the rear of the module.

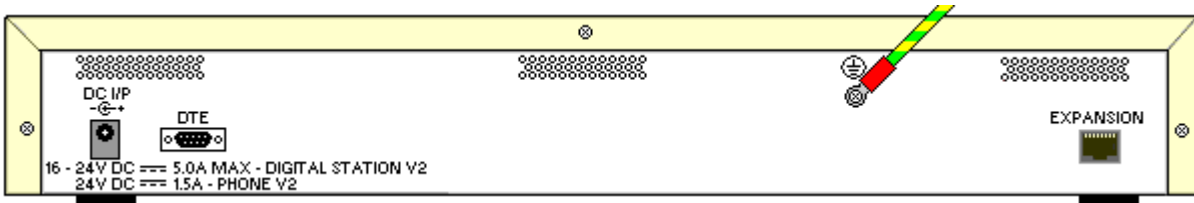

- On some older modules, the dedicated ground point screw is not present. In those cases, the top-center cover fixing screw (3mm) can be used as an alternative ground connection point. A toothed washer should be added to ensure good contact.

7.20 Running System Status Application

In the previous process ([Configuring Security Settings](#)) the Administrator service user was configured to be able to use the IP Office System Status Application (SSA) with the control unit. This application is useful during the following installation processes as it can be used to validate the correct installation of equipment.

By default the System Status Application is enabled for the Administrator service user. For other service users, use of System Status Application must be enabled through the IP Office's security settings.

 **Objective** - Allow SSA to be used to check the correct installation of additional equipment.

 **Procedure**

1. Select **Start | Programs | IP Office | System Status**.
2. On the Logon menu enter the required details. For a default systems these will be:
 - **Control Unit IP Address:** 192.168.42.1
 - **Services Base TCP Port:** 50804
 - **User Name:** Administrator
 - **Password:** Administrator
3. Click Logon.
4. If the details are correct, SSA should show Waiting for connection and then the IP Office system status.

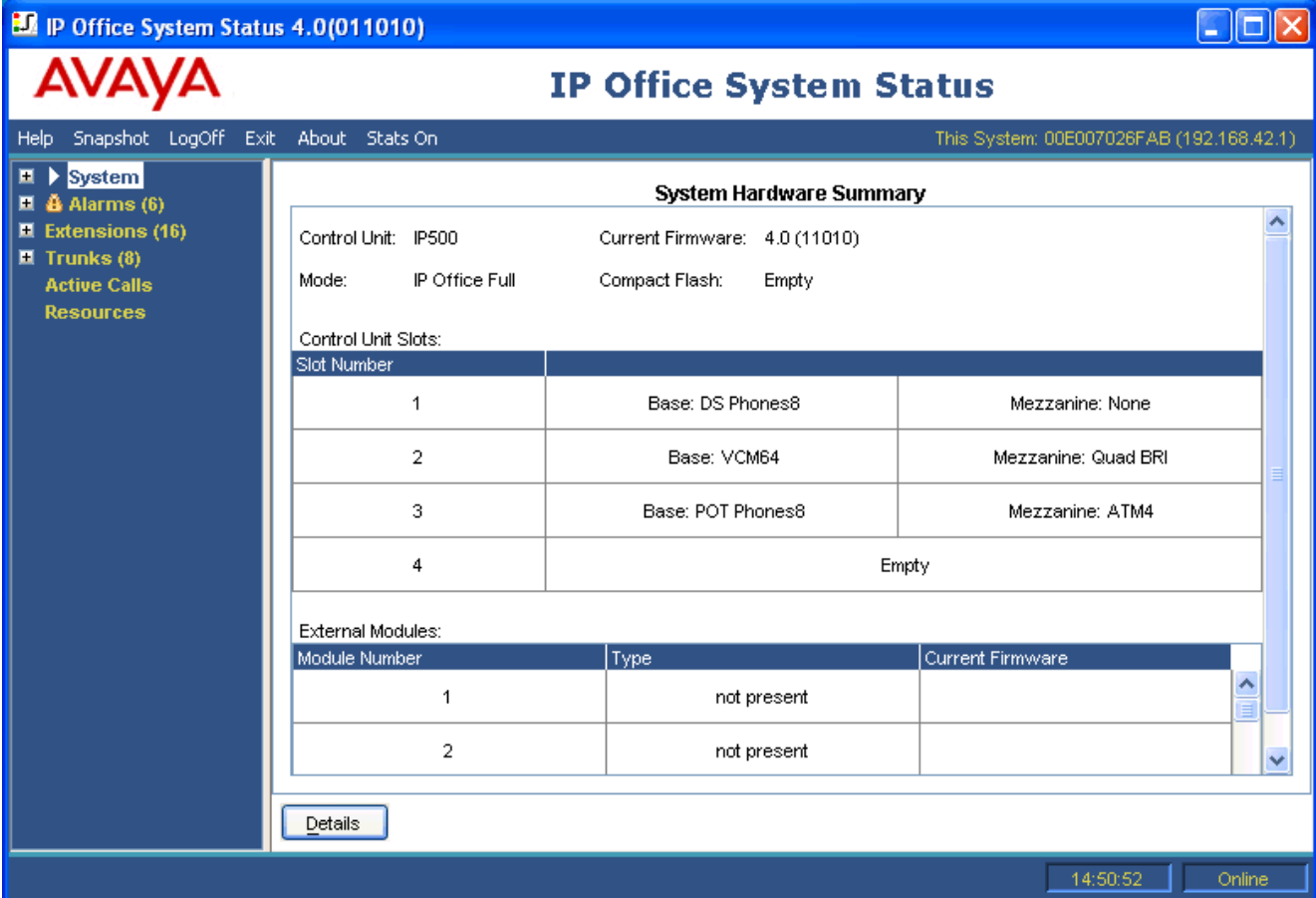

IP Office System Status 4.0(011010)

AVAYA IP Office System Status

Help Snapshot LogOff Exit About Stats On This System: 00E007026FAB (192.168.42.1)

System Hardware Summary

Control Unit: IP500 Current Firmware: 4.0 (11010)
 Mode: IP Office Full Compact Flash: Empty

Control Unit Slots:

Slot Number		
1	Base: DS Phones8	Mezzanine: None
2	Base: VCM64	Mezzanine: Quad BRI
3	Base: POT Phones8	Mezzanine: ATM4
4	Empty	

External Modules:

Module Number	Type	Current Firmware
1	not present	
2	not present	

14:50:52 Online



Chapter 8.

Phone Installation

8. Phone Installation

This section does not cover the installation of IP and wireless phones. They are covered by the following separate documentation:

- **IP Office 3600 Series Installation Manual.**
- **IP Office 4600/5600 IP Phones Installation Manual.**
- **IP Office Compact DECT Installation Manual.**
- **IP DECT Installation Manual.**

This section assumes that phones are being connected to IP Office within an existing RJ45 structured cabling system. If phone connections are being made through older punchdown wiring systems then the installer is expected to be qualified and approved for that type of installation.

Out of Building Connections

Connection to analog and digital phones not located in the same building as the IP Office is only supported with the addition of additional protective equipment and additional installation requirements. See [Out of Building Telephone Installations](#).

8.1 Installing 2400/5400 Series Phones

Normally, when the IP Office system is restarted and Manager is running, the system will compare the firmware loaded on 2400/5400 Series phones against those available in the Manager directory and automatically upgrade if necessary. There may be some rare cases where new firmware files are provided and it is necessary to force the phones to upgrade.

Information Required

1. **Planning Chart.**

This should indicate which extension should connect to which ports on the IP Office system. It should also include intended extension numbers and user details.

Parts and Equipment Required

1. **2400/5400 Series Phone**

Each phone includes a handset and handset cord. No line cord is included. A plastic-wedge is provided to change the phone's angle for wall or desk mounting. In addition for XX10 and XX20 models an adjustable desk stand is included.

2. **Phone connection cable**

These phones are not supplied with a line cord. The cable required will depend on the ports provided at each user position.

2.1. **RJ45-to-RJ11 Cable**

This type of cable will be required if an structured cabling system has been used.

2.2. **RJ11-to-RJ11 Cable**

This type of cable is required if a traditional RJ11 phone socket has been provided at the user position.

3. **IP Office connection cable**

Typically an RJ45-to-RJ45 cable is required for connection from the structured cabling system patch panel to the IP Office control unit or expansion unit DS port.

4. **Wall Fixings**

The phone base is designed to fit directly onto a standard US telephone jack wall plate. Outside the US, two M3 pan-head screws are required, positioned 79mm apart vertically around the phones centerline.

Tools Required

1. **Manager PC**

During installation each 2400/5400 series phone requests software from Manager and then loads that software before becoming operational.



2. **Desk Mounting**

No additional tools required.

3. **Wall Mounting**



If not using a US telephone jack wall plate; drills, screw-drivers and measures for the installation of M3 pan-head screws and wall fixings.

Procedure: Desk Mounting

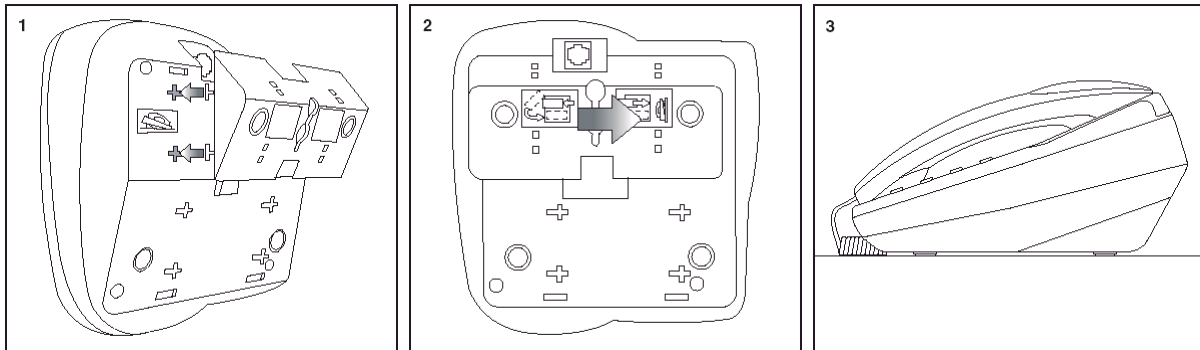
1. At the IP Office end, check that each DS port is connected to the appropriate port in the structured cabling system patch panel.
2. Start Manager. During installation each 2400/5400 series phone requests software from Manager and then loads that software before becoming operational.
3. Unpack the phone.
4. The phones are supplied with the plastic mounting wedge in the wall mounting position as this allows a smaller box size.
5. Slide off the plastic wedge and reattach it in the opposite position so that the phone is now angled for use on a desk.
6. Connect the handset cord to the handset.
7. Connect the handset cord to the port labeled  **HAC**. This is normally located on the left-hand side of the phone.
8. Connect the line cord to the port marked with a  symbol.
9. Connect the line cord to the desk socket.
10. The phone should display Upgrading firmware, please wait and then FIRMWARE UPDATE IN PROGRESS. Once this has completed the should briefly display New Calls: 0 and then the current users name and extension number.
11. For XX10 and XX20 models, assemble the adjustable desk stand. Attach the stand to the base of the phone.



Procedure: Wall Mounting

1. If a standard US telephone jack wall plate is not being used, prepare the wall fixings for the M3 pan head screws being used to mount the phone.
2. At the IP Office end, check that each DS port is connected to the appropriate port in the structured cabling system patch panel.
3. Start Manager. During installation each 2400/5400 series phone requests software from Manager and then loads that software before becoming operational.
4. Unpack the phone.
5. The phones are supplied with the plastic mounting wedge in the wall mounting position as this allows a smaller box size.
6. Slide off the plastic wedge and remove the self-taping screw that is taped inside the wedge.
7. Reattach the plastic wedge in its original position. The self-taping screw can be used to lock the plastic wedge in position.
8. Just below the phones hook-switch is a small plastic square. Remove this and then reinsert it so that a plastic lug projects out towards the hook-switch. This helps ensure that the handset stays in position when the phone is wall mounted.
9. Connect the handset cord to the handset.
10. Connect the handset cord to the port labelled  HAC. This is normally located on the left-hand side of the phone.
11. Connect the line cord to the port marked with a  symbol.
12. Connect the line cord to the wall socket.
13. The phone should display Upgrading firmware, please wait and then FIRMWARE UPDATE IN PROGRESS. Once this has completed the should briefly display New Calls: 0 and then the current users name and extension number.
14. The line cord can be run through the channel in the base of the phone to space at the center. This space can be used to conceal excess cable.
15. Slide the phone onto the exposed heads of the wall mounting position.

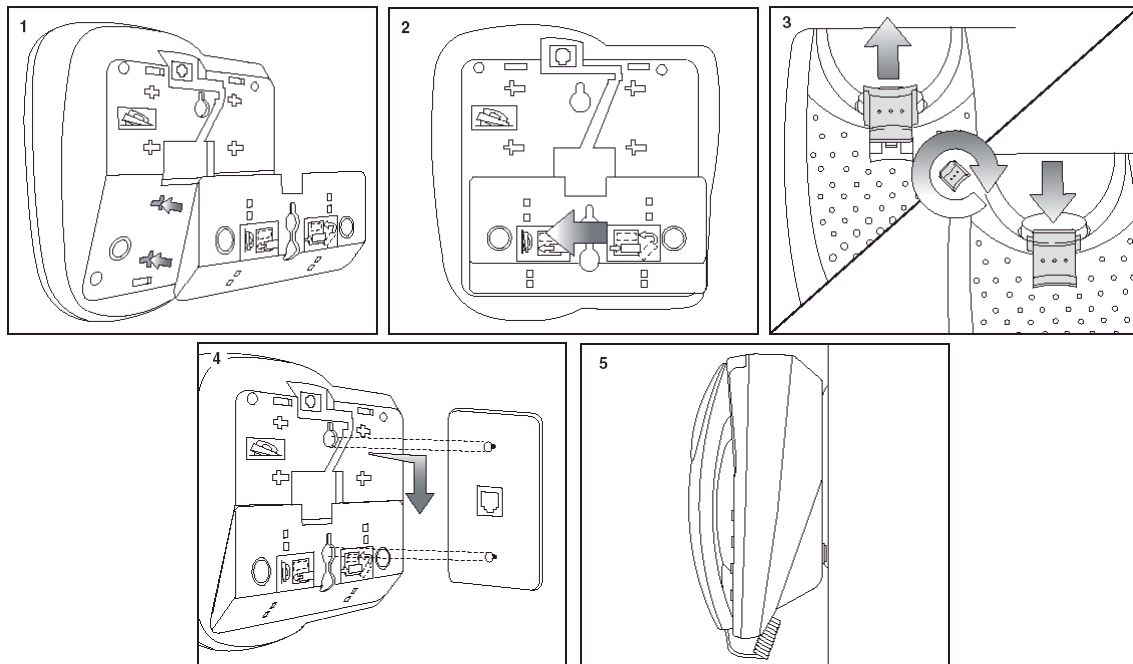



Additional Procedures

1. ✓
2. ✓
3. □

Procedure: Checking the Firmware on a 2410 or 5410 Phone

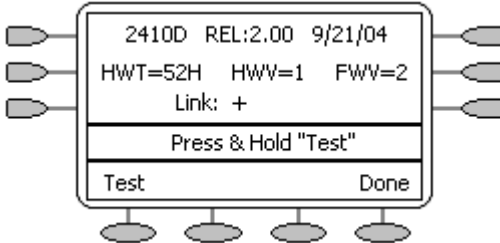
1. Press →  Exit to ensure that the phone has exited any other usage mode.
2. Press either of the display keys next to MENU.
3. Select OPTION.
4. Select Self Test. The display should now show details of the phone's currently installed firmware.





5. The firmware loaded into the phones has a major and minor version. The Major version in the example above is shown as "FWV=2" and the minor version is shown as "REL:2.00".
6. Press →  Exit to exit self test mode.

1. ✓
2. ✓
3. □

Procedure: Checking the Firmware on a 2420 or 5420 Phone

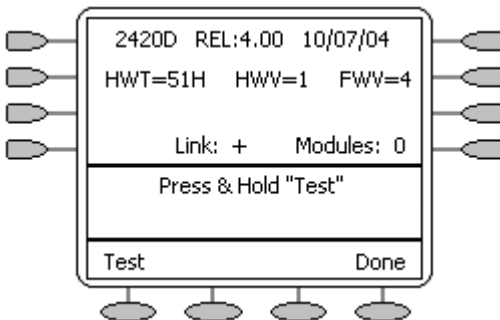
1. Select OPTION.
2. Select Self Test. The display should now show details of the phone's currently installed firmware.



3. The firmware loaded into the phones has a major and minor version. The Major version in the example above is shown as "FWV=4" and the minor version is shown as "REL:4.00".
4. Press →  Exit to exit self test mode.

Procedure: Forcing a Software Upgrade

-  The following procedure should only be used if it has been determined that the 2400/5400 Series phones need to be manually forced to change their firmware. During this process the phone cannot be used.
 - For the IP Office 4.1 Q1 2008 maintenance release and higher, using the batch file to enable the phones to upgrade their firmware is ignored unless the **No User** user **Source Number** of **ALLOW_5410_UPGRADES** is added to the IP Office configuration.
1. Locate the Manager program directory and within it the files turn_on.bat and turn_off.bat.
 2. Right-click on turn_on.bat and select Edit.
 3. Locate the entry <IP Address> and replace this with the IP address of the IP Office system.
 4. Close the file and save the changes.
 5. Repeat steps 2 to 4 for the file turn_off.bat.
 6. Ensure that Manager is running. Manager acts as the TFTP server from which the phones will request firmware files.
 7. Double-click on the file turn_on.bat.
 8. A prompt window should appear asking you to wait and eventually if successful Press any key to continue.
 9. Within Manager, select File | Advanced | Reboot and reboot the IP Office system.
 10. Following the system restart, the 2400 and 5400 Series phones will display Upgrading firmware, please wait and then FIRMWARE UPDATE IN PROGRESS.
 11. Once all the phones have completed their upgrade, double-click on turn_off.bat.

8.2 Installing an EU24 Add-On

The EU24 add-on is supported on IP Office 3.0 and higher. It provides an additional 24 programmable feature keys for the associated phone. The action provided by each of these keys is set through the IP Office configuration. The EU24BL is supported on IP Office 3.1 or higher and provides a backlight function that matches the same facility on the 4621 phone.

A single EU24 or EU24BL is supported on the following phones. A maximum of eight EU24 and or EU24BL per IP Office system.

Phone	EU24	EU24BL
2420/5420	✓	✗
4620/5620	✓	✓
4621/5621	✓	✓
4625	✓	✓

- **⚠ Use Only the Cables Supplied**
Only the cable supplied with the EU24/EU24BL should for connection to the EU24/EU24BL. This cable should only be connected to the port marked EU24 on suitable phones. Doing otherwise will cause damage to the EU24/EU24BL and the equipment to which it is attached.
- **An 1151 Power Supply Must Be Used**
The EU24 and EU24BL require the phone to use an additional 1151 type power supply unit.

1. Procedure: Installing an EU24/EU24BL

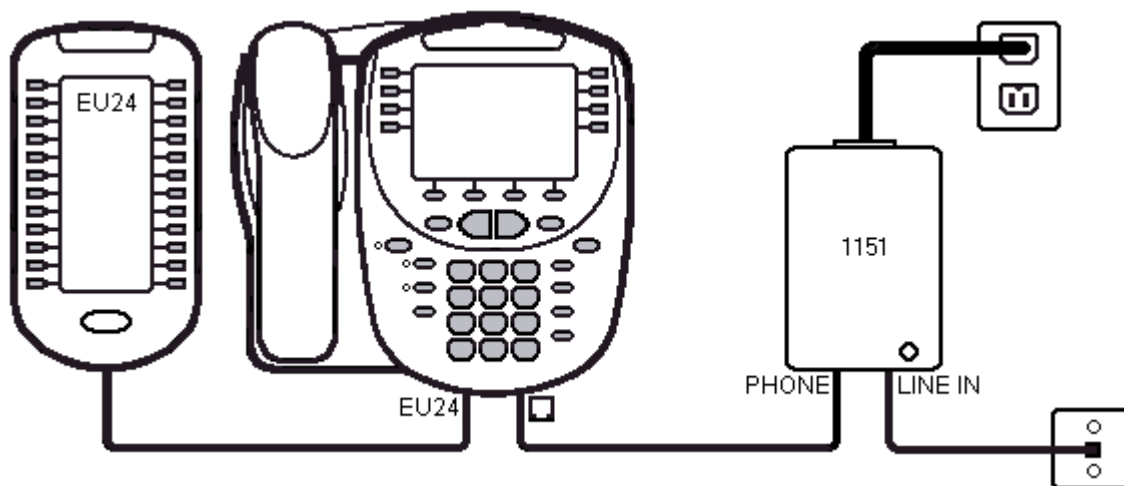

1. Disconnect the existing phone cable from the phone socket to the phone. In the case of IP phones, this will be an existing CAT5 cable. For other phones this will be either an RJ45-to-RJ11 cable or an RJ11-to-RJ11 cable depending on the fixed socket type.
2. Reconnect the same cable from the phone socket to the power supply unit's LINE IN socket.
3. Connect the cable supplied with the PSU, from the power supply unit's PHONE socket to the socket marked  on the phone.
4. Connect the cable supplied with the EU24/EU24BL from the EU24 to the port marked EU24 on the phone.
5. Connect the power supply module to the power outlet socket.

8.3 BM32 Firmware Upgrade

When the BM32 needs a firmware upgrade, please follow the upgrade procedures described below.

Preparation

Place the new firmware for the BM32 modules onto the file server. The file name will be something like GBM32_x_x_x_x.hex.

Amend the 1600 phone upgrade batch file to include the new file name. The example below shows the key lines that need to be added or amended to match the new firmware file.

```
#####
##
## AVAYA 16XX IP TELEPHONE SOFTWARE UPGRADE CONFIGURATION      ##
##                                                              ##
##          *** July 10, 2008 ***                               ##
##                                                              ##
## This file upgrades the following telephones to the indicated releases: ##
##                                                              ##
##   GBM32 - Release 1.0.8                                     ##
#####
IF $MODEL4 SEQ 1616 goto PHONEAPP1616
goto END
#####
##          Check phone application version                    ##
#####

# PHONEAPP1616
SET BMAPPNAME GBM32_B_1_0_8.hex
goto GETSET

#####
##          Get additional configuration files                  ##
#####

# GETSET
GET 46xxsettings.txt
# END
```

Upgrade Procedure

Please follow the following steps to do the upgrade step by step:

1. Remove all BM32 button modules from the 1616 phones.
2. Place the firmware files and amended upgrade batch file onto the file server as detailed above.
3. Connect one BM32 button module to the the 1616 phone using the BM32 cable.
4. When the BM32 button module is booted, it will register to the 1616 phone and then start the download of new BM32 firmware. The download will take about one minute. After download the BM32 will reboot again. When it is rebooted successfully it will get into ready mode.
5. Repeat for other BM32 modules.

8.4 Basic Button Programming

Most Avaya phones have programmable button against which IP Office actions can be programmed. Full details of this are covered by the IP Office Manager help. This section covers only the basic elements of button programming.

Appearance Button Requirements

- **Appearance Functions**

The functions **Call Appearance**, **Bridged Appearance**, **Coverage** and **Line Appearance** are collectively known as "appearance functions". **The following restrictions must be observed for the correct operation of phones.**

- On systems running IP Office 2.1 or 3.0DT software, the first programmable button must be set as a call appearance button. This requirement is necessary for the correct operation of phone functions such as call log.
- For systems running IP Office 3.0 or higher (excluding 3.0DT), the first 3 programmable buttons must be set as call appearance buttons. This requirement is necessary for the correct operation of functions such as transfer, conference and call log.
 - On phones with only two physical programmable buttons both buttons must be used as call appearance buttons.
 - On 1600 Series phones, all the appearance buttons must be programmed as a continuous block with no gaps between the appearance buttons.
 - For IP Office 4.2+, T3 phones support Line Appearance button only and are exempt from the above rules.

1. Procedure

Using IP Office Manager, if only button programming changes are required, the configuration changes can be merged back to the IP Office system without requiring a reboot.

1. Using Manager load the current configuration from the IP Office.
2. Select the  **User** required to display their configuration details.
3. Select Button Programming.

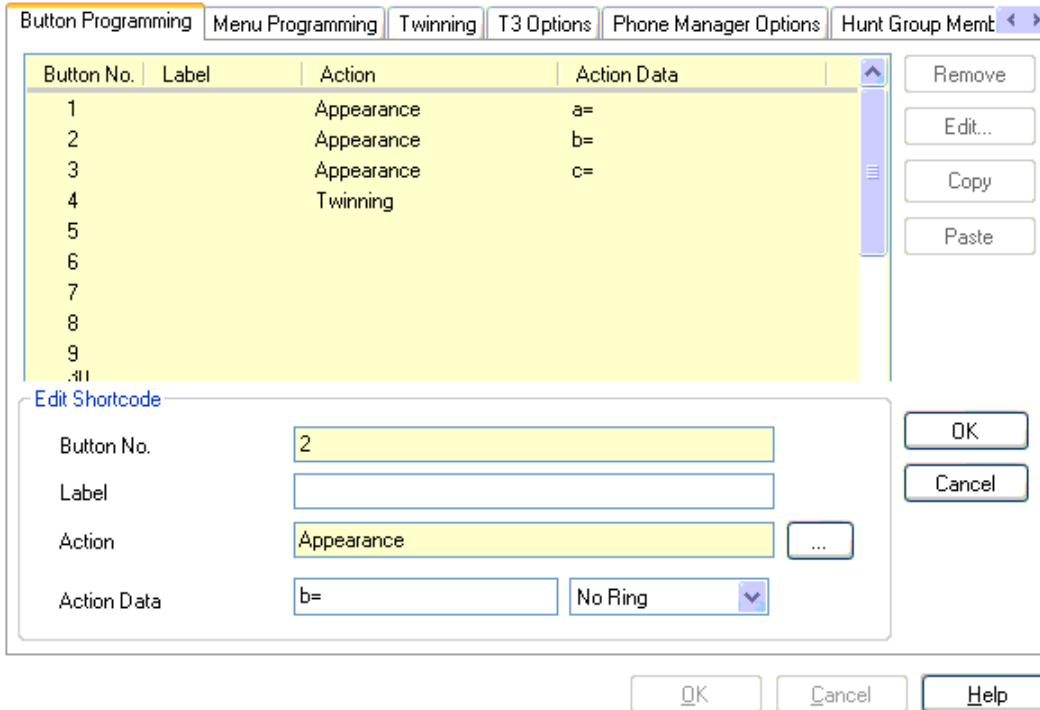

- The number of button displayed is based on the phone associated with the user when the configuration was loaded. This can be overridden by selecting Display All Buttons. This may be necessary for users who switch between different phones using hot desking or have an expansion unit attached to their phone.
4. For the required button, either select the button and then click Edit or double-click the button.
 5. Edit the settings as required. Use the ... button to display the menu for selecting the required button action. Select the action and set the action data, then click **OK**.

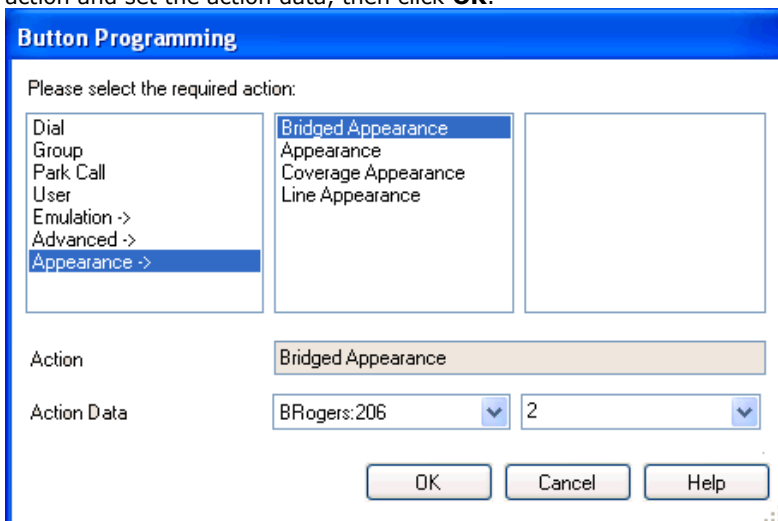



6. Click **OK**. Repeat for any other buttons.
7. Click **OK**.

An alternate method for the above programming is to right-click on the various fields. To do this start with the Action field, then Action Data and then Label if required.

8.5 Changing Extension Numbers

A new or defaulted IP Office system numbers each extension in sequence, going by module and port order, starting from 201. An extension entry is created in the configuration and also an associated user entry. A similar process occurs when a new extension expansion module is detected.

-  **Extension versus User**
It is important with IP Office to understand that "extension number" is a user property that belongs to and moves with the user. For example users can use hot desking to login on another phone and calls to that user's extension number will then go to that phone (the phone temporarily assumes their extension number and settings) until the user log off. The Base Extension value set against extensions in the IP Office configuration indicate the default associated user of the extension, it is not the extension number of that port.

 **Objective** - To change a user's or users' extension number.

1.
2.
3.
4.

Procedure 1: Renumbering all extensions and users

The following process allows all user extension numbers to be shift up or down by a set amount. Any settings linked to those numbers are adjusted including extension Base Extension settings. It does not affect hunt group extension numbers.

1.  This action alters extension settings and so requires a system reboot when the configuration is sent to the IP Office.
2. Select **Tools | Renumber Extension**.

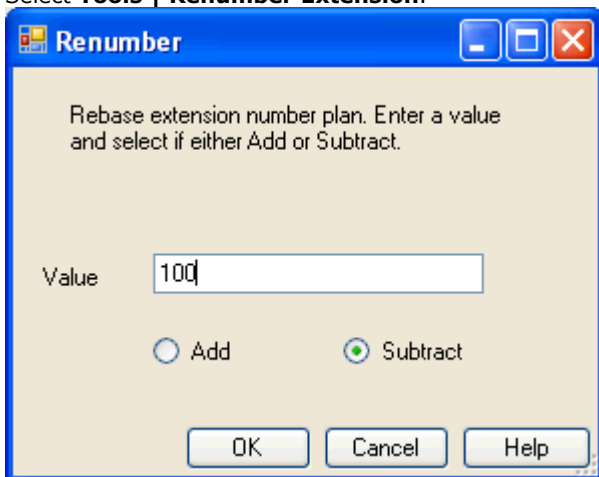



3. Enter the amount by which you want to shift the current extension numbering of extensions and users.
4. Click **OK**.
5. If the configuration changes are complete, send the configuration back to the IP Office and select appropriate settings for the reboot.

Procedure 2: Changing an Individual User's Extension Number

1. Select  **User**.
2. Locate and select the relevant user.
3. On the **User** tab, change the Extension number to the required new number.

User	
Name	SJones
Password	
Confirm Password	
Full Name	Steve Jones
Extension	202
Locale	
Priority	5
	<input type="checkbox"/> Ex Directory

4. Click on another field. If an error warning appears it will most likely be due to a conflict with an existing use of that extension number.
 - If this an error, click Cancel to return the user to their original extension number.
 - If this is intended as the other entry will be corrected click OK and then edit the other entry.
 - When OK is clicked, Manager will automatically propagate the number change to any hunt groups, incoming call routes, user buttons, bridged appearance buttons and call coverage appearance buttons associated with the user's original extension number.
5. If the user has an extension with which they are associated by being the extension's Base Extension setting, that setting is not automatically updated. If the user should still be associated with that extension by default, the extension must be updated manually to match the user's new extension number.
 -  This part of the process requires an IP Office system reboot as it changes extension port settings.

- Select  **Extension**.
- Change the **Base Extension number** to match the user extension who should now be associated with that physical port by default.

Extn	
Extension Id	35
Base Extension	203
Caller Display Type	On
Reset Volume After Calls	<input type="checkbox"/>
Device type	 Avaya 5410
Module	BD
Port	1

- Click **OK**. Manager will probably give a validation error message due to a user being associated with two extensions. This can be ignored until all the user moves have been completed.
6. If changing several users repeat the process as required.
 7. Click  to revalidate the configuration and check that no conflicts between users and associated extensions.
 8. If the configuration changes are complete, send the configuration back to the IP Office and select appropriate settings for the reboot.

8.6 Swapping Extension Users

IP Office 4.2 allows a user to log out when their extension number does not match the **Base Extension** setting of the phone extension they are currently using. Once logged out the user will be automatically re-associated with the extension whose **Base Extension** does match their extension number. This feature allows users to be moved between extensions without needing to change the physical connections or rebooting the IP Office system.

Whilst the example below shows 2 users swapping extensions the method can be used to swap multiple users within the configuration and effecting the swaps after a single merge of the configuration changes.

The process can be used on pre-4.2 IP Office systems but in that case will require the configuration changes to be sent to the IP Office system for a reboot.

Example

User A (202) and User B (203) need to swap extensions.

1. Load the IP Office configuration and select  **Extension**.
2. Locate the extension with the **Base Extension** set to **202**, ie. matching User A's extension number.
 - If the group pane is visible (**View | Group Pane**) in IP Office Manager, it shows the extension details (ID, Module, Port and Base Extension).

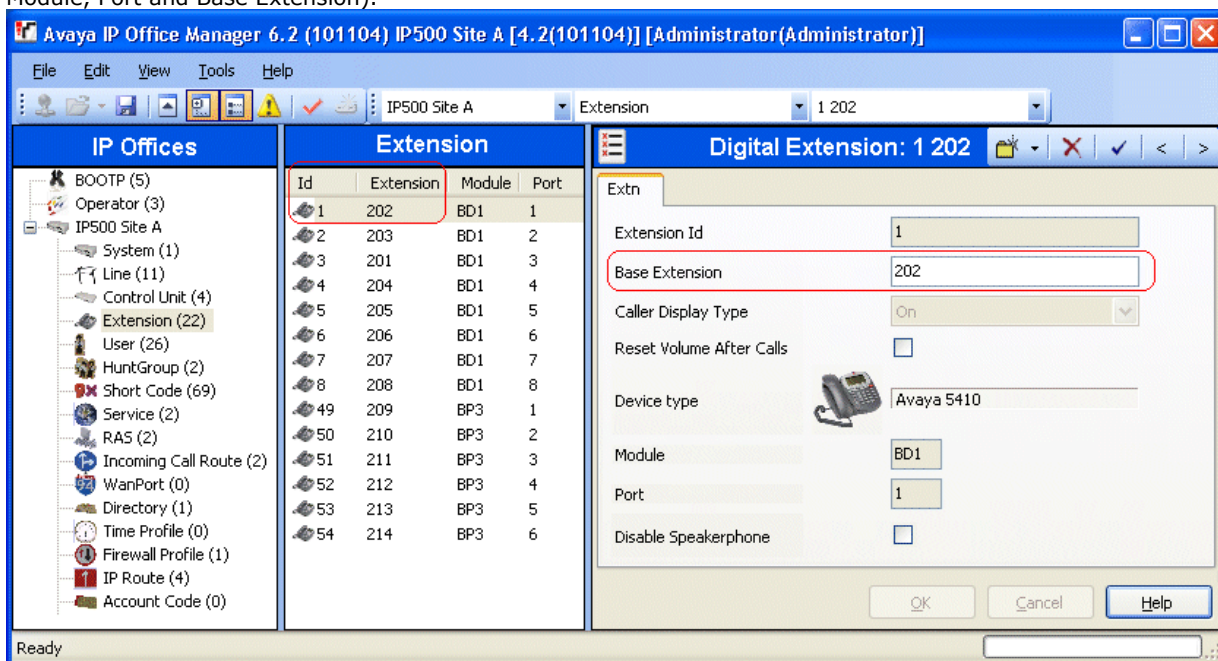

3. Select that extension and change its **Base Extension** setting to **203**, ie. to now match User B's extension number.
 - If IP Office Manager is set to validate edits, it will warn that this change conflicts with the existing Base Extension setting of another extension. Ignore the warning at this stage.
4. Click **OK**. Locate the other extension with the **Base Extension** set to **203**, ie. matching User B's extension number.
5. Select that extension and change its **Base Extension** setting to **202**, ie. to now match User A's extension number.
 - If the error pane is visible (**View | Error Pane**), all the warnings about extension conflicts should have disappeared.
6. Click **OK**. Send the configuration back to the IP Office system.
 - On pre-4.2 systems the configuration changes must be sent to the IP Office using one of the reboot options. Following the system reboot the user will be automatically associated with the appropriate extensions. The remaining steps of this process are not applicable to pre-4.2 IP Office systems.
 - IP Office 4.2+ systems can do this using the merge option. They should then use the following steps to complete the process without having to reboot the system.
7. Ask each of the users to dial the log out short code set on the IP Office system. By default this is ***36**.
 - Having logged out, users on display phones should see the extension number has changed on the phone. They may also see **NoUser** until the user new associated user logs out from the phone they are currently using and is automatically logged in.

- User who do have a login code and are set to **Forced Login** will have to complete the process at their new extension using the login process.

8. The user IP Office configuration settings including their extension numbers will move between the extensions.



Chapter 9.

External Trunk Configuration

9. External Trunk Configuration

This section cover the basic requirements for external trunk configuration. The exactly method of physical connection and configuration will vary with each trunk provider and so requires local telecoms experience. The topics covered here are general guidelines.

- **Clock Quality**
Altering which digital trunk is used to provide the IP Office with its clock signal for call synchronization.
- **Unused Trunks**
Disabling the use of trunks and trunk channels that are not available.
- **Prefix Dialing**
On systems where a prefix is being used for external dialing, ensuring that the same prefix is added to incoming numbers in order to allow return calls.

9.1 Clock Quality

Any system where digital trunks are being used requires a clock signal for call synchronization between the switches at each end of the trunk. Typically the clock signal provided by a digital trunk from the central office exchange is the best quality and most reliable source.

The IP Office can obtain and use the clock signal from any of its digital trunks. However it will only use one trunk for its clock signal at any time and will ignore any other possible clock sources. If no clock source is available the IP Office can use its own internal clock if necessary.

The Clock Quality setting on each line is set to one of the following:

- **Network**
If available, the clock signal from this trunk can be used as the IP Office's clock source.
- **Fallback**
If available, the clock signal from this trunk can be used as the clock source only if none of the trunks set to Network are providing a clock source.
- **Unsuitable**
The clock source from this trunk is never used as the IP Office's clock source.

In the example below the first IP Office is set to use the public network trunk as its clock source and ignoring the possible clock source from the QSIG trunk. However the other system is using the QSIG trunk as it clock source.

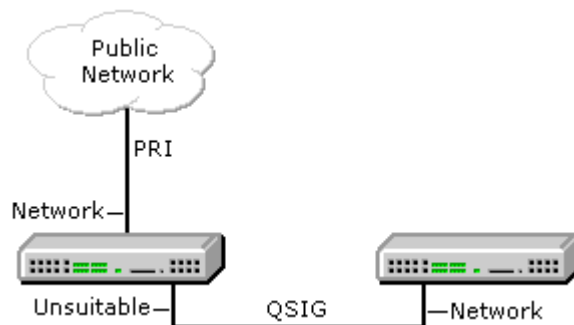

Source Priority

When multiple trunks with the same setting are providing a clock signal, the trunk used is determined in the following order of priority.

- Small Office Edition - Trunks are used in the order of ports 1 to 4.
- IP400 Control Units - Trunks are used in the order Slot B ports 1 to 4, then Slot A ports 1 to 4.
- IP500 Control Unit - Trunks are used in the order of slots 1 to 4 and then by port on each slot.

Viewing the Current Clock Source

The current clock source being used by an IP Office system is shown on the Resources page within the IP Office System Status Application.



Objective - Set a chosen digital trunk as the network clock source and set all other digital trunks as fallback or unsuitable.

1.
2. **Procedure**

1. Within the IP Office configuration, select ~~77~~ Line.
2. For each digital line, select the line and on the Line tab select whether that trunk should provide the clock source for the network or whether the trunk is unsuitable. For E1R2 trunks the Clock Quality setting is on the **Advanced** tab.

PRI 24 Line Channels

Line Number	01	Line SubType	T1
Channel Allocation	24 -> 1		
Prefix			
Clock Quality	Network	Framing	ESF
CRC Checking	Network	Zero Suppression	B&ZS
CSU Operation	<input type="checkbox"/>	Line Signalling	CPE
Haul Length	0-115 ft	Incoming Routing Digits	4
Channel Unit	Foreign Exchange		

3. Ensure that only one trunk is set to Network. This should preferably be a direct digital trunk to the central office exchange.
4. One other trunk can be set a Fallback should the selected Network trunk connection be lost. If possible this should be a trunk from a different provider since that reduces the chances of both sources failing at the same time.
5. Ensure that all other digital trunks are set as Unsuitable.

9.2 Unused Trunks

Each IP Office trunk card provides a fixed number of trunk ports. For digital trunks each trunk provides a set number of digital channels. In cases where the number of trunks connected to the IP Office is lower or the number of channels provided is lower, those unused trunks and channel must be disabled.

- ⚠ Failure to do this will cause problems with outgoing calls. For example, on a system with an ATM4 trunk card fitted but only two analog trunks actually connected, failure to disable the other two trunks within the IP Office configuration will cause 50% of outgoing call attempts to fail.

Objective

Remove unused trunks and channels from the IP Office configuration.

1. Procedure

1. Within the IP Office configuration, select ~~Trunk~~ Line.
2. For each line, set those lines or channels that are not connected or being used as out of service. The location of the relevant setting varies for each trunk type.

- **Analog Trunks**
Set the **Trunk Type** to **Out of Service**.

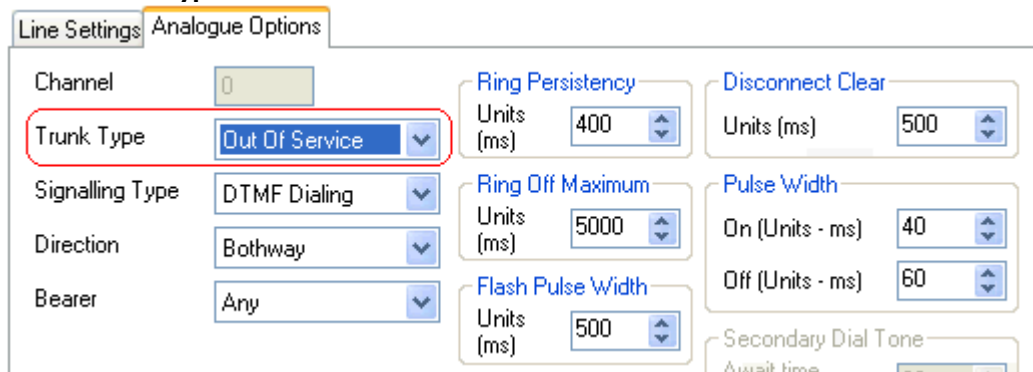

Line Settings Analogue Options

Channel	0	Ring Persistence	Units (ms) 400	Disconnect Clear	Units (ms) 500
Trunk Type	Out Of Service	Ring Off Maximum	Units (ms) 5000	Pulse Width	On (Units - ms) 40
Signalling Type	DTMF Dialing	Flash Pulse Width	Units (ms) 500	Off (Units - ms)	60
Direction	Bothway	Secondary Dial Tone		Await time	
Bearer	Any				

- **BRI, E1 PRI, S0 and QSIG Trunks**
Set the channels quantities to match the actual subscribed channels.

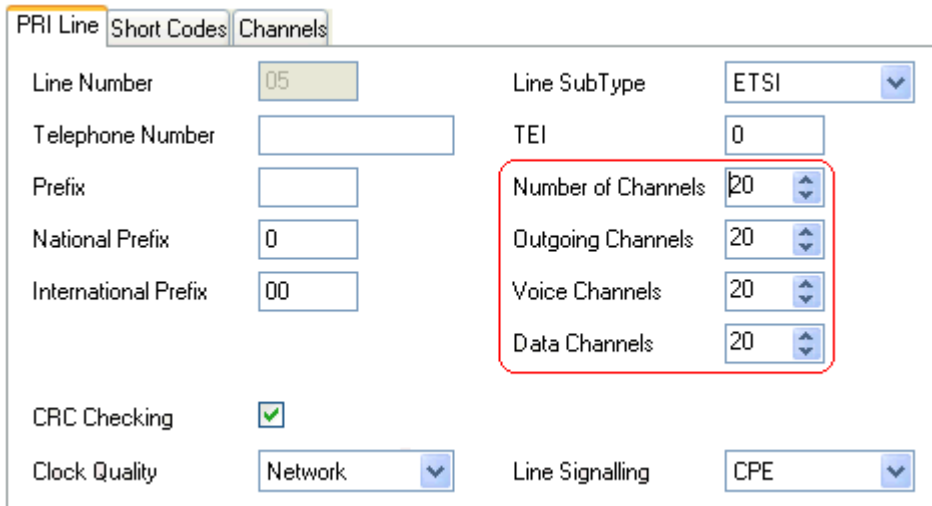

PRI Line Short Codes Channels

Line Number	05	Line SubType	ETSI
Telephone Number		TEI	0
Prefix		Number of Channels	20
National Prefix	0	Outgoing Channels	20
International Prefix	00	Voice Channels	20
		Data Channels	20
CRC Checking	<input checked="" type="checkbox"/>		
Clock Quality	Network	Line Signalling	CPE

- **T1, T1 PRI and E1R2 Trunks**

Select the Channels tab. Select those channels that are not used and click **Edit**.

PRI 24 Line Channels

Channel	Groups	Line Appearance	Direction	Bearer	Type
1	0 0	705	Bothway	Any	Ground Start
2	0 0	706	Bothway	Any	Ground Start
3	0 0	707	Bothway	Any	Ground Start
4	0 0	708	Bothway	Any	Ground Start
5	0 0	709	Bothway	Any	Ground Start
6	0 0	710	Bothway	Any	Ground Start
7	0 0	711	Bothway	Any	Ground Start
8	0 0	712	Bothway	Any	Ground Start
9	0 0	713	Bothway	Any	Out Of Service
10	0 0	714	Bothway	Any	Out Of Service
11	0 0	715	Bothway	Any	Out Of Service
12	0 0	716	Bothway	Any	Out Of Service
13	0 0	717	Bothway	Any	Out Of Service
14	0 0	718	Bothway	Any	Out Of Service
15	0 0	719	Bothway	Any	Out Of Service
16	0 0	720	Bothway	Any	Out Of Service
17	0 0	721	Bothway	Any	Out Of Service
18	0 0	722	Bothway	Any	Out Of Service
19	0 0	723	Bothway	Any	Out Of Service
20	0 0	724	Bothway	Any	Out Of Service
21	0 0	725	Bothway	Any	Out Of Service
22	0 0	726	Bothway	Any	Out Of Service
23	0 0	727	Bothway	Any	Out Of Service
24	0 0	728	Bothway	Any	Out Of Service

Edit...

- For T1 set the **Type** to **Out of Service**.
- For T1 PRI set the **Admin** field to **Out of Service**.
- For E1R2 trunks set the **Line Signalling Type** to **Out of Service**.

9.3 Prefix Dialing

Where a prefix has been implemented for outgoing calls, that same prefix needs to be added to trunk settings. The prefix is then used as follows;

- On incoming calls the prefix is added to any incoming ICLID received with the call. That allows the ICLID to be used by IP Office phones and applications to make return calls.
- Previously, on outgoing calls, any prefix on the digits received by the trunk to dial was removed since that prefix will not be valid at the central office exchange. Unlike previous IP Office releases, IP Office 4.0 does not do this and so whichever short codes are used to route a call to a trunk, they must be setup so as to remove the dialing prefix.

Objective

Ensure the correct prefix is added to incoming calls.

Procedure

1. Within the IP Office configuration, select  Line.
2. For each line enter the prefix. The location of the relevant setting varies for each trunk type.

• Analog Trunks

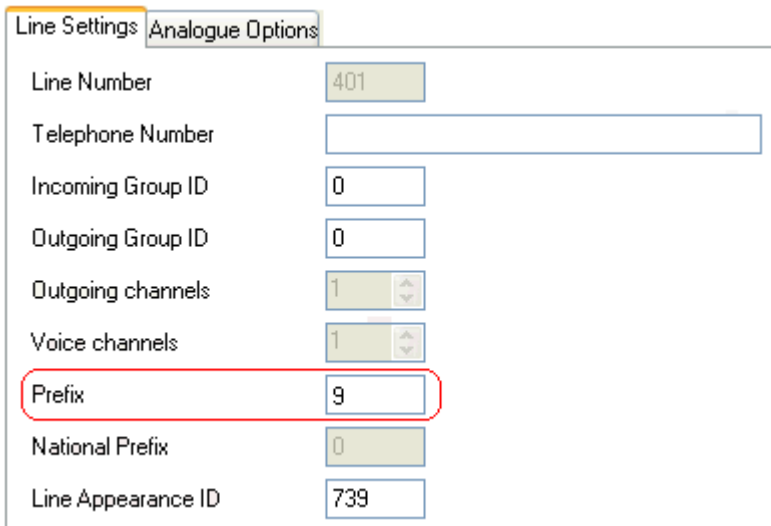

Line Number	401
Telephone Number	
Incoming Group ID	0
Outgoing Group ID	0
Outgoing channels	1
Voice channels	1
Prefix	9
National Prefix	0
Line Appearance ID	739

• T1 and T1 PRI Trunks

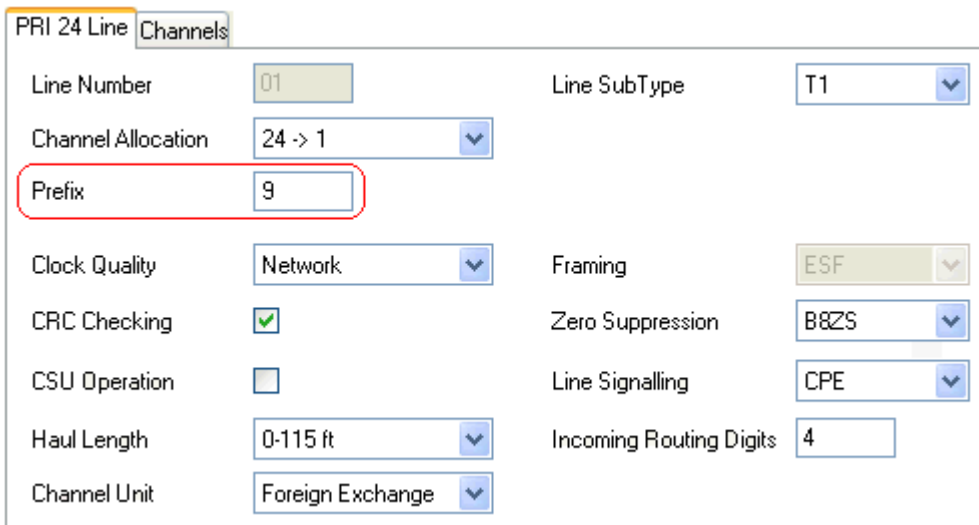

Line Number	01	Line SubType	T1
Channel Allocation	24 -> 1		
Prefix	9		
Clock Quality	Network	Framing	ESF
CRC Checking	<input checked="" type="checkbox"/>	Zero Suppression	B8ZS
CSU Operation	<input type="checkbox"/>	Line Signalling	CPE
Haul Length	0-115 ft	Incoming Routing Digits	4
Channel Unit	Foreign Exchange		

• **BRI, E1 PRI, S0 and QSIG Trunks**

PRI Line		Short Codes		Channels	
Line Number	<input type="text" value="05"/>	Line SubType	<input type="text" value="ETSI"/>		
Telephone Number	<input type="text"/>	TEI	<input type="text" value="0"/>		
Prefix	<input type="text" value="9"/>	Number of Channels	<input type="text" value="20"/>		
National Prefix	<input type="text" value="90"/>	Outgoing Channels	<input type="text" value="20"/>		
International Prefix	<input type="text" value="900"/>	Voice Channels	<input type="text" value="20"/>		
		Data Channels	<input type="text" value="20"/>		
CRC Checking	<input checked="" type="checkbox"/>				
Clock Quality	<input type="text" value="Network"/>	Line Signalling	<input type="text" value="CPE"/>		



Chapter 10.

Additional Processes

10. Additional Processes

10.1 Upgrading the Core Software

The installed IP Office Manager includes [.bin core software](#) files appropriate to the software level. It can be used to load those .bin file into the control unit and modules within the IP Office system.

WARNINGS

- **Check IP Office Technical Bulletins**

Check the latest IP Office Technical Bulletin for the IP Office software release before proceeding any further. It may contain information relating to changes that occurred after this document was completed. Bulletins are available from <http://support.avaya.com>.

- **WAN3 10/100 Modules**

Upgrade each WAN3 10/100 module separately and only after having upgraded the control unit and any other expansion modules.

- **Upgrading pre-Level 2.1 Systems**

For IP Office Systems with software Level 2.0 or earlier, the upgrade procedure must be done from a PC with a fixed IP address on the same subnet and LAN segment as the IP Office.

- **Multi-Stage Upgrades**

Due to the need to adjust internal memory allocation and configuration storage, for some upgrades the control unit may need to perform multi-stage upgrade process. The table below indicates the require upgrade paths.

Control Unit	.bin File	Unvalidated Only	Validated
Small Office Edition	ip401ng.bin	2.0 > 2.1	2.1 > 3.0 > 3.1 > 3.2 > 3.2(999) > 4.2.
IP406 V2	ip406u.bin	-	2.1 > 3.0 > 3.0(999) > 3.1 > 3.1(999) > 3.2 > 4.2.
IP412	ip412.bin	1.3 > 2.1	2.1 > 3.0 > 3.1 > 3.2 > 4.2.
IP500	ip500.bin	-	4.0.0 > 4.2.

- **Multiple Managers**

If more than one copy of Manager is running it is possible for the IP Office to request BIN files from a different Manager from the one that started the upgrade process. Ensure that only one copy of Manager is running when upgrading an IP Office system.

- **Other IP Office Applications**

Upgrading the core software of the IP Office control unit may require upgrades to associated software. Typically IP Office is compatible with the previous release of most IP Office applications, however for each IP Office core software release there may be exceptions. These exceptions will be detailed in the Technical Bulletin for the IP Office core software release.



Information Required

1. **System Password** - For a new or defaulted system this is password.

Tools Required

1. **Manager PC** - The Upgrade Wizard tool is part of the Manager application.

Procedure: Upgrade Procedure

1. Using Manager, click  and receive the configuration from the IP Office. If not already done this action creates a BOOTP entry in Manager for the IP Office system. This action also confirms communication between the Manager PC and the IP Office.
2. Select **File | Save Configuration As...** and save a copy of the configuration file onto the PC. This action should be completed before upgrading any IP Office system.
3. Select **File | Advanced | Upgrade.**
4. The UpgradeWiz is started and scans for IP Office modules using the Unit/Broadcast address. Adjust this address and click Refresh if the expected modules are not shown.
5. For each the control unit and module found, the UpgradeWiz displays the module type, its current version of software installed in the unit and the software version of the .bin file that Manager has available.
6. For those units and modules where manager detects that it has a higher version available, the tick box next to the unit or module is automatically selected.
7. If any of the modules have pre-version 2.1 software installed, untick the Validate option.
 -  If this is the case, only continue with the upgrade process using a PC with a fixed IP address on the same LAN domain and physical LAN segment as the IP Office control unit.
8. If a multi-stage upgrade is necessary, use the following additional steps to select the appropriate interim software:
 - Right-click on the upgrade wizard and click Select Directory. Locate and select the directory containing the bin file for the intermediate software level.
 - The upgrade wizard should now list just the control unit as having upgrade software available. For the remainder of the upgrade as detailed below, the upgrade can be rerun again select the final software for the control unit.
9. For those modules which you want to upgrade, tick the check box. For modules where a later version of software is available the check box may have already been automatically ticked. If doing a multistage upgrade, only the control unit is selectable for the first stage.
 - For systems including WAN3 modules, untick the WAN3 modules. Each WAN3 module should be upgraded separately once the control unit and modules in the same system have been upgraded.
10. Select **Upgrade.**
11. The system password will be requested. Enter it and click OK.
12. **Validated Upgrade**
If using the Validated option, a number of actions take place as follows;
 - Firstly the upgrade wizard performs initial checks on the amount of free RAM memory available in the IP Office system to temporarily store the new BIN files during the upgrade process. If insufficient memory is available, you will be prompted whether to continue with an off-line upgrade or cancel upgrading.
 - If offline is selected, the IP Office is rebooted into offline mode. It may be necessary to use the Refresh option within the Upgrade Wizard to reconnect following the reboot. Validate upgrade can then be attempted to again check the amount of available RAM memory for transfer of BIN files. If the memory is still insufficient, the option is offered to either do an unvalidated upgrade or cancel.
 - The bin files required are transferred to the system and stored in temporary memory.
 - Once all the files have been transferred, the upgrade wizard will prompt whether it okay to proceed with the upgrade process. Select Yes to continue.
 - Each module being upgraded will delete its existing core software, restart and load the new software file that was transferred. This process may take several minutes for each unit. Do not cancel or close the upgrade wizard while this process is running.
13. **Unvalidated Upgrade**
This method of upgrading should be avoided unless absolutely necessary. It is only required for IP Office systems with pre-2.1 software and should only be done from a Manager PC with a fixed IP address running on the same LAN segment and subnet as the IP Office system. During the upgrade the units and modules erases their current software and then request the new software file from Manager.
14. Following the upgrade check that the upgrade wizard now shows that the selected units and modules have upgraded. It may be necessary to select Refresh to update the information in the upgrade wizard display.
15. Repeat the process as required. For example if doing a multi-stage control unit upgrade or if there are WAN3 modules in the system that are being upgraded separately.

10.2 Creating a WAN Link

The following is a simplified process for creating a data link from Site A to Site B via the WAN ports.

At Site A on IP address 192.168.43.1.

1. Create a Normal Service

The Service name can be any text and is used to identify this particular service. The account Name and password entered for the service are presented to the remote end, therefore must match the user name and password configured at Site B. The Encrypted Password option can only be used if the remote end also supports CHAP.

2. Create a User

Under the Dial In tab, tick Dial In On. This User account is used to authenticate the connection from the Site B. Note that if the Service and User have the same name these two configuration forms are automatically linked and become an Intranet Service. The User password is displayed at the bottom of the Service tab as the Incoming Password.

3. Setup RAS

If CHAP is to be used on this link then the Encrypted Password option must be checked in the Service and in the RAS service. The name of the RAS service must match the name of the Service at Site B. Note that if the RAS settings are given the same name as the Service and User they are automatically linked and become a WAN Service. Ensure that the Encrypted Password option is not checked when using a WAN Service.

4. Edit the WANPort

Note: Do not create a new WANPort, this is automatically detected. If a WANPort is not displayed, connect the WAN cable, reboot the Control Unit and receive the configuration. The WANPort configuration form should now be added.

5. Create an IP Route

In the IP Address field enter the network address of the remote end, not the IP address of the Control Unit. Under Destination select the Service created above.

At Site B on IP address 192.168.45.1

1. Repeat the above process but altering the details to create a route from Site B to Site A

10.3 IP500 Reset Button

The IP500 control unit includes a Reset button not found on other IP Office control unit.

Pressing the button while the control unit is starting up will pause the start up until the button is released.

The effect of pressing the button during normal operation will depend on how long the button is pressed and is indicated by the CPU LED.

Press Duration (seconds)	CPU LED	Action	Summary
0 to 5.	Off	None	None.
5 to 10.	Orange	Reboot When Free	Reboot when free with new incoming/outgoing call barring. A reboot using the reset button is recorded in the Audit Trail.
10 to 30.	Flashing orange	Erase Configuration/ Immediate Reboot	Erase the configuration, alarm log and audit trail. Immediate reboot without waiting for active calls to end. See Erasing the configuration for full details.
30 to 40.	Red	Erase All.	Erase configuration, alarm log and core software. See Erasing the Operational Software for full details.
Over 40.	Flashing green	None	None.

10.4 Out of Building Telephone Installations

The following are the only supported scenarios in which wired extensions and devices outside the main building can be connected to the IP Office system. In these scenarios, additional protection, in the form of protective grounding and surge protectors, must be fitted.

- ⚠ The fitting of additional protection does not remove the risk of damage. It merely reduces the chances of damage.

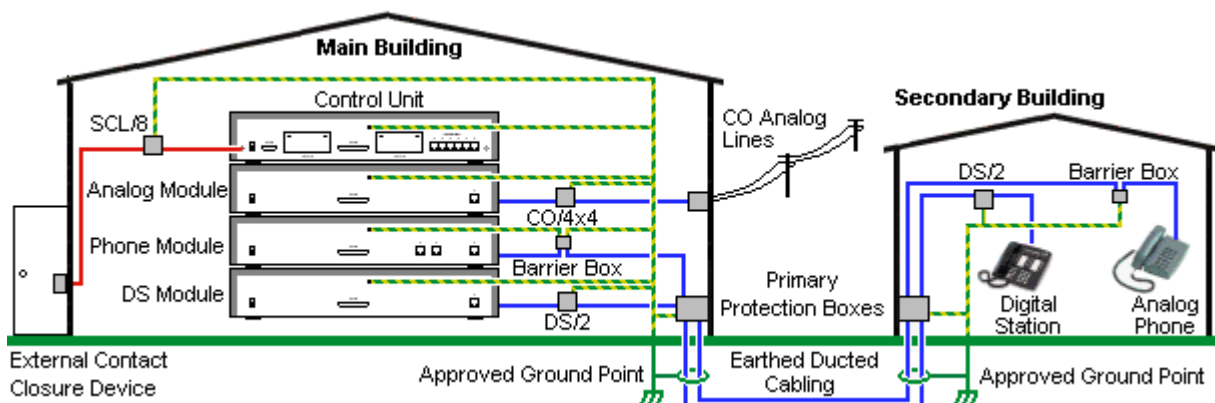

Cabling Requirements

- Cables of different types, for example trunk lines, extensions, ground and power connections, should be kept separate.
- All cabling between building should be enclosed in grounded ducting. Ideally this ducting should be buried.
- A Primary Protection Box must be provided at the point where the cables enter the building. This should be three point protection (tip, ring and ground). Typically this would be gas tube protection provided by the local telephone company. The ground wire must be thick enough to handle all the lines being affected by indirect strike at the same time.

Connection Type	Protection Device Type	Requirement
DS Phone Extensions ⚠ Digital Station Expansion module DS ports only.	ITWLinx towerMAX DS/2 Supports up to 4 connections. (This device was previously referred to as the Avaya 146E).	<ul style="list-style-type: none"> Connection from the expansion module to the phone must be via a surge protector at each end and via the primary protection point in each building. The IP Office expansion module and control unit and IROB devices must be connected to the protective ground point in their building.
Analog Phone Extensions ⚠ Phones Expansion module (POT or PHONE) ports only.	IP Office Barrier Box Supports a single connection. Maximum of 16 on any expansion module.	<ul style="list-style-type: none"> The between building connection must be via earthed ducting, preferable underground. The cable must not be exposed externally at any point.
Analog Trunks	ITWLinx towerMAX CO/4x4 Supports up to 4 two-wire lines. (This device was previously referred to as the Avaya 146C).	For installations in the Republic of South Africa, the fitting of surge protection on analog trunks is a requirement. For other locations where the risk of lightning strikes is felt to be high, additional protection of incoming analog trunks is recommended.
External Output Switch	ITWLinx towerMAX SCL/8 (This device was previously referred to as the Avaya 146G)	Connections from an IP Office Ext O/P port to an external relay device must be via a surge protector.

The towerMAX range of devices are supplied by ITWLinx (<http://www.itwlinx.com>).

10.4.1 DS Phones

When digital phone extensions are required in another building, additional In-Range Out-Of-Building (IROB) protective equipment must be used. For phones connected to IP Office DS ports, the supported device supplied by ITWLinx is a towerMAX DS/2 module. This IROB device was previously badged by Avaya as the 146E IROB.



CAUTION

Ports on the front of the Small Office Edition, IP403 and IP406 V2 control units must not be used for extensions that are external to the main building.

The protection device should be installed as per the instructions supplied with the device. The ground points on the IP Office control unit and the DS modules must be connected to a protective ground using 18AWG wire with a green and yellow sleeve.

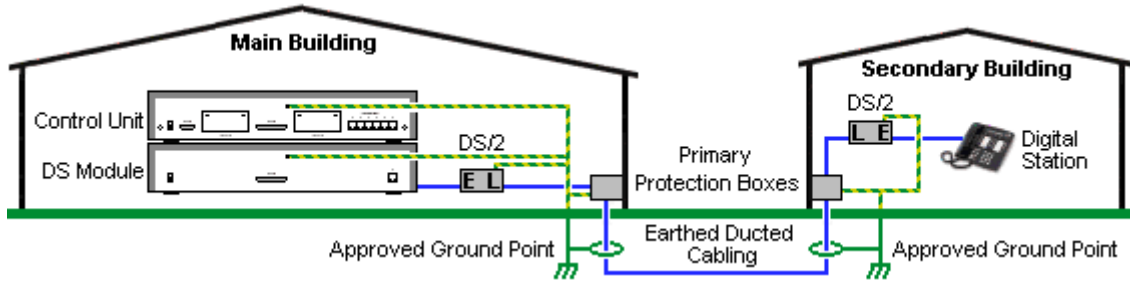
Typically the IROB's 2 RJ45 EQUIPMENT ports are straight through connected to the 2 RJ45 LINE ports. This allows existing RJ45 structured cabling, using pins 4 and 5, to be used without rewiring for up to two DS connection. However each of these ports can be used to connect a second extension using pins 3 and 6.

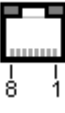
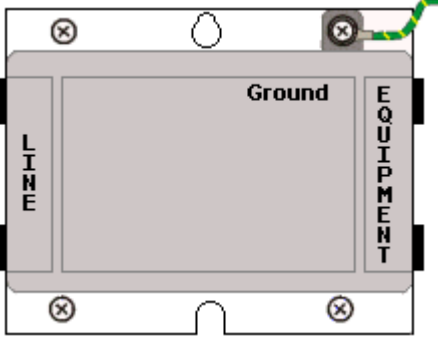

LINE	Signal	EQUIPMENT
 8 1	1	Not used.
	2	Not used.
	3	Ring II (Optional)
	4	Ring I
	5	Tip I
	6	Tip II (Optional)
	7	Not used.
	8	Not used.
		 8 1

10.4.2 Analog Phone Barrier Box

Where analog phone extensions are required in another building, additional protective equipment must be used, in the form of IP Office Phone Barrier Boxes and protective earth connections.

- The correct IP Office specific barrier boxes must be used. These modules have been designed specifically for the signalling voltages used by the IP Office system:
 - Only the IP Office Phone Barrier Box should be used with Phone V1 modules.
 - Only the IP Office Phone Barrier Box V2 should be used with Phone V2 modules.
 - No other type of analog phone barrier box should be used.
- Where more than 3 barrier boxes are required in a building, they must be rack mounted using a [Barrier Box rack mounting kit](#).
- A maximum of 16 barrier boxes can be used with any Phone module.
- CAUTION: PHONE (POT) ports on the front of control units must not be used for extensions that are external to the main building.
- The Phone Barrier Box does not connect the ringing capacitor in Phone V1 modules.

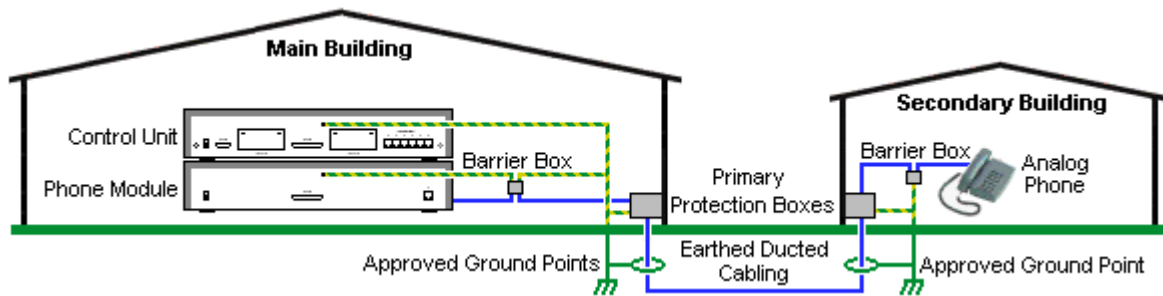

Main Building	Barrier Box	Secondary Building
<ul style="list-style-type: none"> • RJ11: Connect to PHONE (POT) port on the Phone module using cable supplied with the barrier box. • RJ45: Connect to the secondary building barrier box via primary protection in both buildings. 		<ul style="list-style-type: none"> • RJ11: Connect to analog phone. Cable not supplied. • RJ45: From main building via primary protection in both buildings.
<ul style="list-style-type: none"> • Center Screw: Connect to main building protective ground (or ground terminal of Barrier Box Rack Mounting Kit). Use 18AWG (minimum) wire with a green and yellow sleeve. • Right-Hand Screw: Connect to ground point on Phone module using ground cable supplied with barrier box. 		<ul style="list-style-type: none"> • Center Screw: Connect to main building protective ground. Use 18AWG (minimum) wire with a green and yellow sleeve. • Right-Hand Screw: Not used.

1. The following wires must be kept apart, that is not routed in the same bundle:

- Earth leads from the barrier box to the IP400 Phone modules.
- Internal wires, for example extension leads going directly to the IP400 Phone modules.
- Wires from external telephone going directly to the barrier boxes.

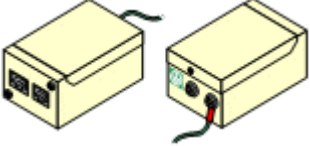
IP Office Barrier Boxes	SAP Code	
	<p>IP400 Phone Barrier Box (81V) Use with Phone V1 module. Includes an RJ45 to RJ11 cable and a functional earth lead.</p>	700293897
	<p>IP400 Phone Barrier Box V2 (101V) Use with Phone V2 module. Includes an RJ45 to RJ11 cable and a functional earth lead.</p>	700385495
	<p>Barrier Box Rack Mounting Kit</p>	700293905

10.4.3 Rack Mounting Barrier Boxes

Where more than 3 Phone Barrier Boxes are used they must be rack mounted. The Barrier Box Rack Mounting Kit (SAP Code 700293905) supports up to 8 Phone Barrier Boxes.

1. Unscrew the two screws arranged diagonally at the front of each barrier box and use these same screws to reattach the barrier box to the rack mounting strip.
2. Each barrier box is supplied with a solid green ground wire connected to its functional ground screw. Remove and discard this wire. Connect a green/yellow ground wire to the protective earth screw in the center of the Point on the back of the Barrier Box.

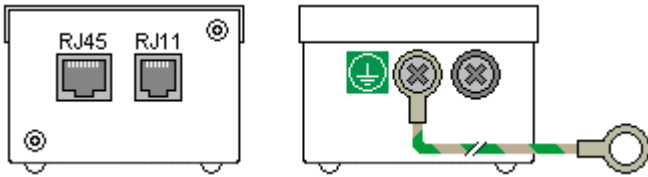

3. The rack mounting strip has threaded M4 earthing pillars. Connect the other end of the barrier box ground wire, using M4 washers and nuts, to the earthing pillar on that side of the rack mounting strip.

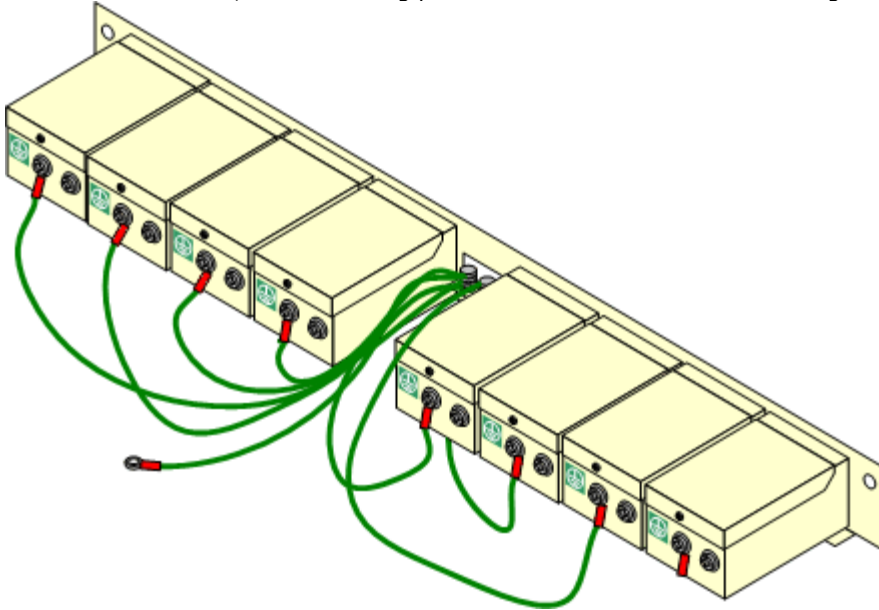

4. Using 14AWG wire with green and yellow sleeve, connect one of the earthing pillars to the buildings protective earth.
5. Using 14AWG wire with green and yellow sleeve, connect the other earthing pillar to the Phone module.
6. Ensure that the following wires are not routed together in the same bundle:
 - Earth lead from the barrier box to the IP400 Phone 8/16/32.
 - Internal wires, e.g. wires going directly to the IP400 Phone 8/16/32.
 - Wires from external telephone going directly to the barrier boxes.

10.5 Using the External Output Port

All the IP Office control units are equipped with a EXT O/P port. The port is marked as EXT O/P and is located on the back of the control unit adjacent to the power supply input socket.

The port can be used to control up to two external devices such as door entry relay switches. The usual application for these switches is to activate relays on door entry systems. However, as long as the criteria for maximum current, voltage and if necessary protection are met, the switches can be used for other applications.

The switches can be switched closed, open or pulsed (closed for 5 seconds and then open). This can be done in a number of ways:

- Using IP Office short codes.
- Through the Door tab in Phone Manager Pro.
- Through the Door Release option in IP Office SoftConsole.
- Via the Open Door action in Voicemail Pro.

Default Short Codes

The following are the default short codes in the IP Office configuration for external output switch operation. They use the short code features Relay On (closed), Relay Off (open) and Relay Pulse.

State	Switch 1	Switch 2
Closed	*39	*42
Open	*40	*43
Pulse	*41	*44

10.5.1 Port Connection

These ports are found on the rear of all IP Office control units. They are used for connection to external switching relays. The port uses a standard 3.5mm stereo jack plug for connection.

The IP Office is able to open (high resistance), close (low resistance) or pulse (close for 5 seconds and then open) two switches within the port. Either switch can be operated separately. These switches are intended for activation of external relays in systems such as door opening systems.

- **CAUTION:** In installations where this port is connected to a device external to the building, connection must be via a towerMAX SCL/8 Surge Protector and a protective ground connection must be provided on the IP Office control unit.

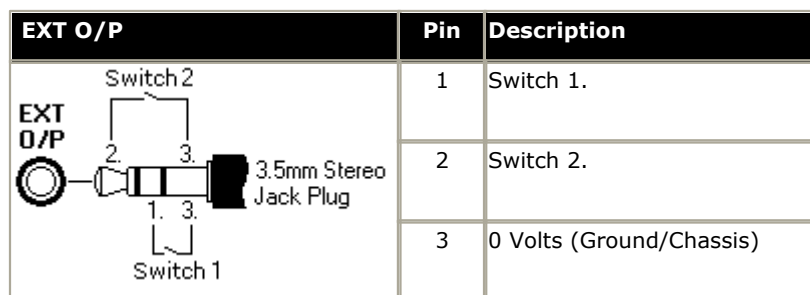

- Switching Capacity: 0.7A.
- Maximum Voltage: 55V d.c.
- On state resistance: 0.7 ohms.
- Short circuit current: 1A.
- Reverse circuit current capacity: 1.4A.
- Ensure that pins 1 and 2 are always at a positive voltage with respect to pin 3.

3.5mm stereo audio jack plugs are frequently sold as pre-wired sealed modules. It may be necessary to use a multi-meter to determine the wiring connections from an available plug. Typically 3 (common to both relays) is the cable screen.

10.6 Licensing

10.6.1 License Keys

Various IP Office features and applications require entry of license keys into the system's configuration. The license keys are unique 32-character codes based on the feature being activated and the serial number of the IP Office system's [Feature Key dongle](#).

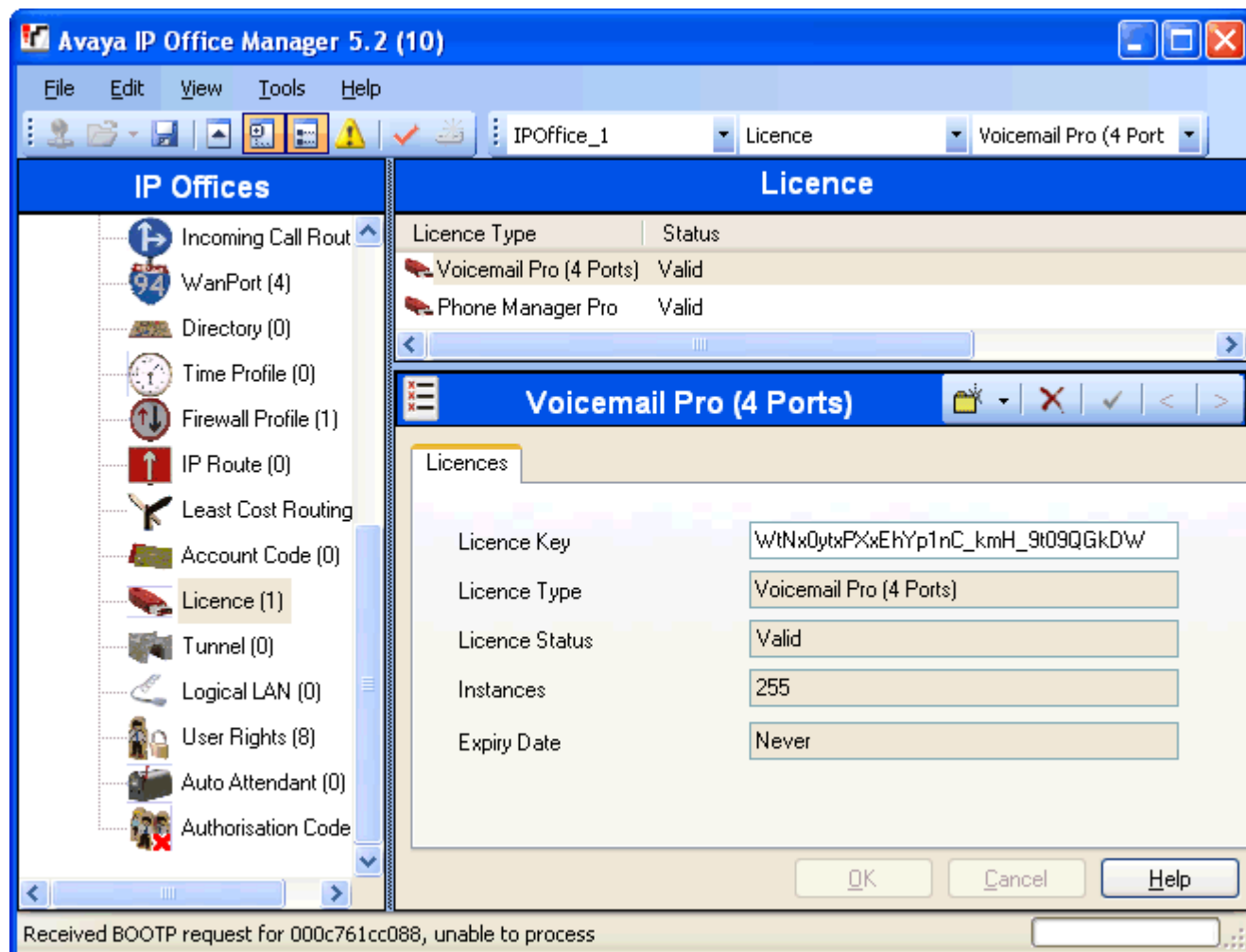

• Example 1: Enabling Software Features

In the example above, the IP Office system has a valid Phone Manager Pro license. In this case the license is for 20 instances. That means that up to 20 IP Office users can be configured to use Phone Manager Pro simultaneously. Their previously license free Phone Manager Lite software will automatically change to display Phone Manager Pro features.

• Example 2: Enabling Software and Features

The example above the IP Office also a license for Voicemail Pro. This initial Voicemail Pro license provide for 4 ports between the IP Office system and the Voicemail Pro PC. Additional Voicemail Pro (ports) licenses can be added to cumulative increase the number of port up to the limit supported by the particular type of IP Office control unit.

When a license key is entered into the IP Office configuration, the following information is shown.

• Status

The status, which is Unknown until the configuration file is sent back to the IP Office system.

• License

The name of the licensed feature. This may differ from the ordered RFA name.

• Instances

Depending on the license, this may be the number of ports enabled or number of simultaneous users of the licensed feature. Sometime the number of instances is specified in the license name.

• Expires

Most purchased licenses have no expiry setting. For some features, trial licenses may be available which will have an expiry date.

10.6.2 Feature Key Dongles

Various IP Office features and applications require entry of a [licence key](#) or keys into the system's configuration. Each licence key is a unique 32-character number based on the feature being activated and the serial number of a Feature Key dongle installed somewhere with the IP Office system.

- 



• **PC-Less Licensing**
Uses a feature key dongle inserted or attached to the rear of the control unit. This method can be used with any of the IP Office control units supported by IP Office 4.0 and is mandatory with the IP500 control unit.



-

• **PC-Base Licensing**
This method uses a dongle attached to a PC running the IP Office Feature Key server application. This PC must be on the same LAN segment as the IP Office control unit. Typically the dongle and IP Office Feature Key server application are installed on the same PC as the IP Office Voicemail Lite or Voicemail Pro application if present.

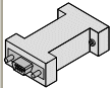
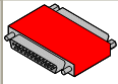
There are three type of Feature Key dongle available. The serial number is printed either directly onto the dongle or onto a label on the dongle.

Feature Key Type	Description	SOE	IP406 V2	IP412	IP500	SAP Code
Smart Card 	Inserts into a dedicated slot on the rear of the IP500 control unit. This card is required on IP500 systems even if not using any IP Office licenses.	✗	✗	✗	✓	MU-Law 700417470 A-Law 700417488
Serial 	Plugs directly into the DTE serial port on the rear of the control unit allowing PC-less operation.	✓	✓	✓	✗	700293095
Parallel 	Plugs into the appropriate port on a PC running the IP Office Feature Key server application. This PC must on the same LAN segment as the IP Office control unit.	✓	✓	✓	✗	700185234
USB 		✓	✓	✓	✗	700261506

10.6.3 Installation Requirements

Software

- The IP Office Administration CD contains the Feature Key Server software. This is required for use with USB and parallel port licence keys.

Feature Key

- Ensure that the serial number on the Feature Key dongle is noted and recorded in a safe location. The number is printed on the Feature Key dongle and prefixed with SN.

Feature Key Server PC





Only required if using a Parallel Port or USB Feature Key. Not applicable if using a Serial Port Feature Key dongle.

- Windows 2000, 2003 or XP are strongly recommended as the Feature Key Server is then able to install as a service, giving greater reliability.
- The server PC should be located in a secure area. The Feature Key device is fundamental to the correct operation of many features, so a record of its location and serial number must be kept.
- Parallel Port Feature Key:
 - A 25-pin Parallel port 1, set to bidirectional operation in the PC's BIOS.
 - Bidirectional parallel port operation is the normal default on most PCs.
 - **WARNING:** Do not connect a printer to the parallel port Feature Key dongle. Poorly wired printer cables or printers that have not been earthed correctly can cause the parallel port Feature Key to stop working.
- USB Feature Key:
 - USB 1.1 or 2.0. Type A connector.
 - IP Office 1.4 Admin suite or later.





Network

- The PC should be configured and tested for TCP/IP networking.
- It should be on the same network segment as the IP Office. That is data traffic between the IP Office and the Feature Key Server PC should not require routing.
- The PC should have a fixed IP address. Whilst PC's in a DHCP network usually retain the same IP address between reboots this is not guaranteed.
 - If the IP Office is acting as a DHCP server, then in default it uses addresses 192.168.42.2 to 192.168.42.201 for DHCP clients. This leaves addresses between 192.168.42.202 and 192.168.42.254 free for devices that require fixed IP addresses.

10.6.4 Serial Port Feature Key Installation

1. Plug the serial port Feature Key dongle into the serial port on the IP Office control unit (IP Office Small Office Edition, IP406 V2 and IP412 control units).
2. Start Manager and receive the IP Office system's configuration.
3. Select  **System**.
4. On the **System** tab, the **License Server IP Address** field is used to set the location of the feature key. For a serial port license key, set the **License Server IP Address** to be blank.
5. Click **OK**.
6. Select  **License**.
7. To add a license, click  and select **License**. Enter the new license click **OK**.
8. The **Status** of the new license should show Unknown and name the license as expected. If its **Status** is **Unknown** and name **Invalid**, the most likely cause is incorrect entry of the license key characters.
9. Click on  to send the configuration back to the IP Office. The menu that appears will indicate whether a reboot is required.
10. Use Manager to receive the configuration again and check that the status of the license. It should now be **Valid**.

10.6.5 Parallel / USB Port Feature Key Installation

1. Plug the Feature Key dongle into the PC's parallel or USB port.
2. Insert the IP Office Administrator Applications CD and let the installation wizard auto-start.
3. If some IP Office administrator application have been previously installed, select Modify when the Modify, Repair or Remove option menu appears.
4. In the Select Features menu, ensure that Feature Key Server is selected. Do not change any other options as this will trigger their removal if already installed.
5. Having installed the software, the system will reboot.
 - The Feature Key Server installs itself as a service. It appears as Key Server in the Services Panel.
 - In the **Add/Remove Programs** panel, an entry Sentinel System Driver appears. This is part of the Feature Key Server.
6. Following installation and reboot, the Feature Key Server appears as an icon  in the Windows System Tray.
 - Right-click on the icon and select About to display the server software version and the Feature Key device number.
 - If the icon appears as a white block with a red cross through it, then there is some error. The most likely error is that the Feature Key is missing from the parallel or USB port.
7. Start Manager and receive the IP Office system's configuration.
8. Select  **System**.
9. On the **System** tab, the **License Server IP Address** field is used to set the location of the feature key. The default is a **255.255.255.255** broadcast address. This is okay for many sites, but it is recommend that the IP address of the PC running the Feature Key Server is entered.
10. Click **OK**.
11. Select  **License**.
12. To add a license, click  and select **License**. Enter the new license click **OK**.
13. The **Status** of the new license should show **Unknown** and name the license as expected. If its Status is **Unknown** and name **Invalid**, the most likely cause is incorrect entry of the license key characters.
14. Click on  to send the configuration back to the IP Office. The menu that appears will indicate whether a reboot is required.
15. Use Manager to receive the configuration again and check that the status of the license. It should now be Valid.

10.7 So8 BRI Module

10.7.1 Example 1: ISDN Terminal

In this example, calls on DID 123456 are routed to the first port of the So8 expansion module. That port has been configured as Line Group ID 701.

1. Configure an Incoming Call Routing

The destination is a short code that directs the call to the line group ID that contains the So lines. The **Bearer Capability** has been set to **Any**, to allow data and voice via this route.

- **Line Group ID:** 0
- **Incoming Number:** 123456
- **Destination:** 123456
- **Bearer Capability:** Any

2. Create a System Short Code:

This is the destination used in the Incoming Call Route.

- **Short Code:** 123456
- **Telephone Number:** 123456
- **Line Group ID:** 701
- **Feature:** Dial

3. Send the configuration to the Control Unit.

Any call coming into the main system on DID 123456 will now be passed directly to the first port.

If you wish to assign DID's from your main pool to individual ports and avoid network charges when dialing between them, try variations on the following:

1. You have DID ranges, for example: 7325551000 to 7325551099. You wish to assign 7325551000-19 to port 1 and 7325551020-20 to port 2 etc.

2. Configure Incoming Call Route:

The # is used here instead of "n" to avoid problems with "Main". The minus sign means the number is processed from the left and so will wait for the whole number.

- Line Group ID: 701
- Incoming Number: -100x
- Destination: #

3. Repeat for Line Group ID 702 etc.

4. Create Short codes, for example:

- Short Code: 100x
- Telephone Number: .
- Line Group ID: 701
- Feature: Dial

S0 calls dialed without the area code are handled locally without network charges. Calls with area calls will go via the network.

10.7.2 Example 2: Video Conference

In this example, calls are routed to a Polycom Viewstation module connected to a S0 port of the IP Office system.

The following settings were used on 4 incoming data channels of a PRI line:

- Line Number: 5
- Channel Allocation: 23 -> 1
- Switch Type: 5ESS
- Line Sub Type: PRI
- Provider: AT&T
- Channels: 1-4
- Incoming Line Group: 95
- Outgoing Line Group: 95
- Direction: Bothway
- Bearer: Data
- Service: Accunet (this is a important)
- Admin: In Service

To route an incoming video call on the PRI lines configured above to an SO8 module requires the following:

1. Create a dial short code that has the SO port as its destination Line Group. For this example the following was used:

- Short Code: 1500
- Number: .
- Feature: Dial
- Line Group: 601 (the SO8 port number)

2. Create an Incoming Call Routing that routes the appropriate calls to that short code. For this example the following was used:

- Line Group: 95 (identifies calls using the PRI lines configured above)
- Destination: 1500 (the short code created above)
- Bearer: Any

To allow the video device on the S0 port to make outgoing calls to the PRI lines also requires a short code.

1. For this example the following was used:

- Code: 91N;
- Number: N
- Feature: Dial
- Line Group: 95

Polycom Video Module Settings

The Polycom modules used in the previous example were the Viewstation 128, Viewstation 256 and Viewstation MP.

The Polycom module must have software that supports 'Standard ETSI ISDN' (European ISDN) and have its ISDN Switch Protocol setting set to 'Standard ETSI Euro-ISDN'

The following were the settings used during testing:

Characteristics	Admin/Software and Hardware/Software
<ul style="list-style-type: none"> • Polycom View Station 512 MP. • NTSC UIS Interface. • View Station PVS 1419. 	<ul style="list-style-type: none"> • Software: 7.0.1. • Network Interface: S/T Interface. • ISDN Version: IEUS v18:a00320
Admin/General Setup	Admin/Video Network/ISDN Video Network
<ul style="list-style-type: none"> • Country: USA • Language: English (USA) • Auto Answer: Yes • AllowDial: Yes • Allow User Setup: Yes • Maximum Time on Call: 480. 	<ul style="list-style-type: none"> • Country Code: 1 • Area Code: 732 • Number A: blank • Number B: blank • ISDN Switch Protocol: Standard ETSI Euro-ISDN.
User Setup	Admin/Video Network/IMUX
<ul style="list-style-type: none"> • Auto Answer: Yes • PIP: Auto • Far Control of Near Camera: Yes • MP Mode: Auto 	<ul style="list-style-type: none"> • Numbers: blank • SPID: blank • Audio Quality: 168KB/s • Advanced Dialing: Dial Channels in Parallel
System Information	Admin/Software and Hardware/Hardware
<ul style="list-style-type: none"> • Release: 7.0.1 • Model: VS: 512 	<ul style="list-style-type: none"> • Camera: NTSC • Video Comm Interface: ISDN_Quad_BRI • Network Interface Type: S/T Interface
Admin/Video Network	Admin/Video Network/Call Preference
<ul style="list-style-type: none"> • MultiPoint Setup: Auto 	<ul style="list-style-type: none"> • ISDN Video Calls (H:320): Yes

10.8 SNMP

10.8.1 SNMP Introduction

SNMP (Simple Network Management Protocol) is a standard network protocol that allows the monitoring and management of data devices across a network.

An SNMP agent can be built into network devices such as routers and hubs. An SNMP manager application (for example CastleRock or HP OpenView) can then communicate with those devices.

This communication can be:

- **Polling:** *Supported by IP Office 2.0 and above*

Some SNMP manager applications send out polling messages to the network. They then record the responds of any SNMP enabled devices (agents). This allows the manager to create a network map and to raise an alarm when devices previously present do not respond.

- Most SNMP manager applications can also do simple IP address polling to locate non-SNMP enabled devices. However this method of polling does not identify the device type or other information.
- SNMP polling including details about the responding device. For example an IP Office control unit's response includes the control unit type, level of software, routing table information, up time, etc.

- **Traps:** *Supported by IP Office 2.0 and above*

When certain events occur, a devices SNMP agent can send details of the event to the SNMP manager. This is called an SNMP 'trap'. These appear in the event log of the SNMP manager. Most SNMP manager's can be configured to give additional alerts in response to particular traps.

- **Management:** *Not supported by IP Office 2.0 and above*

Some SNMP agents support device management and configuration changes through the SNMP manager interface.

IP Office 2.0 and above allows IP Office Control Units to act as read-only SNMP v1 agents. It can include the sending of events traps to up to two different SNMP manager addresses.

- IP Office 3.2 supports the use of SMTP to email SNMP alarms. This allows the IP Office's SNMP alarms to be used without having to setup an SNMP manager application.

IP Office SNMP operation has been tested against Castle Rock SNMPc-EE 5.1.6c and HP OpenView Network Node Manager 6.41.

- A MIB file exists for the SNMP monitoring of Avaya 4600 and 5600 Series IP phones. The MIB file can be obtained from the Avaya support website (<http://support.avaya.com>).
- The Avaya IP DECT system can also be monitored using SNMP. Refer to the IP DECT Installation manual.

10.8.2 Installing the IP Office MIB Files

To allow full communication between an SNMP agent and an SNMP manager, the SNMP manager must load MIB files (Management Information Base) specific to the SNMP agent device and the features it supports. These MIB files contain details of the information the agent can provide and the traps that it can send. Full details of the structure of the IP Office MIB files, MIB groups within those files and event traps can be found in the "IP Office Installation Manual".

The MIB files for IP Office operation are included on the IP Office Admin CD in the folder C:\snmp_mibs. The actual files required and the method of loading depend on the SNMP manager application being used. The details below cover the two SNMP manager applications tested.

HP Open View Network Node Manager

1. Copy the following MIB files to the applications MIBs folder.

	MIB File	Source
a.	rfc2737-entity-mib.mib	snmp_mibs\standard folder on OpenView Install CD.
b.	avayagen-mib.mib	snmp_mibs\IPOffice folder on IP Office Admin CD.
c.	ipo-prod-mib.mib	snmp_mibs\IPOffice folder on IP Office Admin CD.
d.	ipo-mib.mib	snmp_mibs\IPOffice folder on IP Office Admin CD.
e.	inet-address-mib.mib	snmp_mibs\Standard folder on IP Office Admin CD.
f.	rfc2213-integrated-services-mib.mib	snmp_mibs\standard folder on OpenView Install CD.
g.	diffserv-dscp-tc.mib	snmp_mibs\Standard folder on IP Office Admin CD.
h.	diffserv-mib-ipv4.mib	snmp_mibs\Standard folder on IP Office Admin CD.
i.	ipo-phones-mib.mib	snmp_mibs\IPOffice folder on IP Office Admin CD.

2. Start the OpenView Network Node Manager console.

3. Select Options and then Load/Unload MIBs: SNMP.

4. Select Load and select all the MIB files listed above.

5. Select Compile.

1. Copy the following MIB files to the applications MIBs folder, normally C:\Program Files\SNMPc Network Manager\mibfiles.

	MIB file	Source
a.	ENTITY-MIB	snmp_mibs\Standard on IP Office Admin CD.
b.	AVAYAGEN-MIB.mib	snmp_mibs\IPOffice on IP Office Admin CD.
c.	IPO-PROD-MIB.mib	snmp_mibs\IPOffice on IP Office Admin CD.
d.	IPO-MIB.mib	snmp_mibs\IPOffice on IP Office Admin CD.
e.	INET-ADDRESS-MIB.mib	snmp_mibs\Standard on IP Office Admin CD.
f.	INTEGRATED-SERVICES-MIB	snmp_mibs\Standard on IP Office Admin CD.
g.	DIFFSERV-DSCP-TC.mib	snmp_mibs\Standard on IP Office Admin CD.
h.	DIFFSERV-MIB.mib	snmp_mibs\Standard on IP Office Admin CD.
i.	IPO-PHONES-MIB.mib	snmp_mibs\IPOffice on IP Office Admin CD.

- In SMNPc select Config | MIB Database.
- Select Add and select the MIB files listed above in the order listed.

CastleRock SNMPc V5.0.1

The MIB installation instructions provided above are correct for CastleRock SNMPc V5.0.8 and later. For V5.0.1 of CastleRock SNMPc the following must be carried out:

- Copy all of the IP Office MIBs and standard MIBs from the IP Office Administrator Applications CD to the SNMPc mibfiles directory.
- In the SNMPc mibfiles directory open the files STANDARD.mib and SNMPv2-SMI.mib in Notepad.
- In the SNMPv2-SMI.mib file find the definition of zeroDotZero and copy this to the clipboard.
- In the STANDARD.MIB file find the SNMPv2-SMI section and paste in the definition of zeroDotZero from the clipboard before the end of this section (just before the END statement).
- Save the modified STANDARD.MIB file.
- Add the MIB file SNMP-FRAMEWORK-MIB.mib to the MIB database using the instructions provided in the IP Office installation guide.
- Add all the MIB files listed in the instructions provided in the IP Office installation guide in the order given.
- Compile the MIBs ready for use.

The reason for this is: The IPO-PHONES-MIB.mib relies upon the DIFFSERV-MIB.mib for the definition of the textual convention of IndexInteger. The DIFFSERV-MIB needs the definition of the textual convention zeroDotZero which is normally defined in SNMPv2-SMI.mib. However including SNMPv2-SMI.mib in the MIB file compilation list results in errors due to conflicts with what appear to be internal definitions within SNMPc and the SNMPv2-SMI section in its STANDARD.mib file. Therefore to resolve the issue the required definition of zeroDotZero must be placed in the SNMPv2-SMI section in SNMPc's STANDARD.mib file.

10.8.3 Enabling SNMP and Polling Support

In order for the IP Office control unit to be discovered and polled by an SNMP manager, its SNMP agent must be enabled and placed in the same read community as the SNMP manager.

To enable the SNMP agent:

1. In Manager, receive the control unit's configuration.
2. Double-click **System** from the Configuration Tree panel and select the SNMP tab.
3. Tick **SNMP Enabled**.
4. In SNMP Port, enter the UDP port number used by the IP Office SNMP agent to listen for and respond to SNMP traffic. The normal default is 161.
5. In **Community (Read-only)**, enter the community to which the device belongs for read access. This community name must match that used by the SNMP manager application when sending requests to the device. The community public is frequently used to establish communication and then changed (at both the SNMP agent and manager ends) for security.
6. Click **OK**.
7. Send the configuration back to the IP Office and select reboot.
8. Following the IP Office reboot, the SNMP manager should be able to discover the control unit.
9. The control unit's response will include details of the control unit type and the current level of core software.

10.8.4 Enabling SNMP Trap Sending

In Manager, receive the control unit's configuration.

1. Double-click System from the Configuration Tree panel and select the SNMP tab.
2. Ensure that SNMP Enabled is ticked.
3. Using either Trap Destination 1 or Trap Destination 2, enter the following information:
 - Enter the IP Address of the PC running the SNMP manager application.
 - Enter the Port on which the traps messages should be sent. This is the UDP port on which the IP Office sends SNMP trap messages. The default is 162.
 - Set the Community that will be used by the agent and the SNMP manager. The community public is frequently used to establish communication and then changed (at both the SNMP agent and manager ends) for security.
 - Select the **Events** which should be sent:
 - **Generic:**
Events such as soft reboot (warm start), hard reboot (cold start), links up/down (transition in the status of a PPP or frame relay interface) or SNMP community mismatch.
 - **Entity:**
Failures, errors and changes of state in IP Office modules and trunk interfaces. Note: Does not include WAN3, Modem2 and ATM4.
 - **Licence:**
Changes of state in the communication with the Feature Key Server.
 - **Phone Change:**
Changes to the type of DS or IP phone connected to a port.
4. Click on **OK**.
5. Send the configuration back to the IP Office and select reboot.

10.8.5 Trap Generation

RFC1215 Generic SNMP Traps

Trap	Cause
warmStart	Soft reboot.
coldStart	Unexpected reboot such as a power outage.
linkDown	Transition of an interface (PPP or Frame-Relay) from the up operational state into the down operational state.
linkUp	Transition of an interface (PPP or Frame-Relay) from the down operational state into the up operational state.
authenticationFailure	SNMP request with mismatched community for the type of operation.

IPO-MIB

Trap	Cause
ipoGenEntityFailureEvent	A physical entity has fails in its operation
ipoGenEntityOperationalEvent	A physical entity becomes operational again after having failed. .
ipoGenEntityErrorEvent	A transitory error is detected for a physical entity.
ipoGenEntityChangeEvent	A non-error change event is detected for a physical entity.
ipoGenLKSCommsFailureEvent	Loss of communication with a configured License Key Server.
ipoGenLKSCommsOperationalEvent	Communication with the configured License Key Server established or reestablished.
ipoGenLKSCommsErrorEvent	Currently not used.
ipoGenLKSCommsChangeEvent	Currently not used.
ipoGenVMSCommsFailureEvent	Loss of communication to the voicemail system.
ipoGenVMSCommsOperationalEvent	Link to the voicemail system established or reestablished.
ipoGenVMSCommsErrorEvent	Currently not used.
ipoGenVMSCommsChangeEvent	Currently not used.
ipoGenDSCommsFailureEvent	Loss of communication to the delta server.
ipoGenDSCommsOperationalEvent	Communication to the delta server established or reestablished.
ipoGenDSCommsErrorEvent	Currently not used.
ipoGenDSCommsChangeEvent	Currently not used.

The traps above are generated for the physical entities as follows:

Expansion Modules

Trap	Phone	Digital Station	Analog Trunk	S08	WAN3
ipoGenEntityFailureEvent	✓	✓	✓	✓	✗
ipoGenEntityOperationalEvent	✓	✓	✓	✓	✗
ipoGenEntityErrorEvent	✓	✓	✓	✓	✗
ipoGenEntityChangeEvent	✓	✓	✓	✓	✗

Where:

- ipoGenEntityFailureEvent and ipoGenEntityOperationalEvent traps are issued in relation to connecting cable disconnection and reconnection or power changes.

- ipoGenEntityErrorEvent trap is issued for transitory communication errors across the cabling to an expansion module.
- ipoGenEntityChangeEvent trap is issued for mismatch(es) in expansion modules discovered at controller start up and those present in the system configuration.

Trunk Interfaces

Trap	Analog	BRI	E1	E1R2	T1 PRI
ipoGenEntityFailureEvent	X	✓	✓	✓	✓
ipoGenEntityOperationalEvent	X	✓	✓	✓	✓

- Where ipoGenEntityFailureEvent and ipoGenEntityOperationalEvent traps are issued in relation to link status changes.

Integral Modules

Trap	Modem	Voice Compressor
ipoGenEntityFailureEvent	X	✓
ipoGenEntityOperationalEvent	X	✓

- Where ipoGenEntityFailureEvent and ipoGenEntityOperationalEvent traps are issued for voice compressor modules in relation to data access problems that result in code reload

Other Plug-In Modules

- The ipoGenEntityChangeEvent trap is issued for changes to the PCMCIA card slot population on the IP Office Small Office Edition control unit.

IPO-PHONES-MIB:

Trap	Cause
ipoPhonesChangeEvent	Upon change of a DS or IP extension phone type after normal start-up. No traps are issued for PHONE (POT) extensions as the presence or absence of such phones cannot be established hence the ipoPhonesType for such extensions is always potPhone.

10.9 DTE Port Maintenance

10.9.1 DTE Port Overview

The DTE port on the back of IP Office control units is not normally used when configuring an IP Office system. However, in extreme cases, the DTE port can be used to default the system's configuration or to erase its core software if necessary.

- ⚠ WARNING**

Due to the drastic nature of these actions, they should only be performed if absolutely necessary to return a system back to working order. In both cases, you must make every effort to ensure that you have a backup copy of the system configuration.

The DTE ports on IP Office expansion modules are not used for any maintenance or diagnostics except under instruction from Avaya.

10.9.2 DTE Port Settings

These ports are found on the rear of all IP Office control units and external expansion modules. The DTE ports on external expansion modules are not used.

The RS232 DTE ports on the control units can be used for system maintenance and connection of serial terminal adaptors. On IP400 control units the port can also be used for connection of the IP Office serial port licence key dongle.

An asynchronous terminal program such as HyperTerminal is also required. Configure this for operation via a PC serial port, as follows:

Bits per second	38,400	Parity	None	Flow Control	None
Data bits	8	Stop Bits	1	Settings Emulation	TTY

DTE Cables

These cables are used for system maintenance and diagnostics under Avaya guidance. They can also be used for connection of RS232 serial terminal adaptor equipment to the IP Office control unit.

The cable required depends on the IP Office control unit. This cable is a "Straight through DB9 female to DB9 male serial cable".

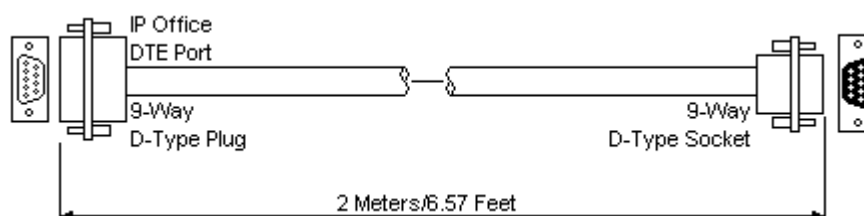

IP Office 9-Way RS232 DTE Port	Signal	PC/Terminal Adaptor
3	← Receive data	3
2	→ Transmit Data	2
7	← RTS (Request To Send)	7
8	→ CTS (Clear To Send)	8
6	→ DSR (Data Set Ready)	6
5	● Ground	5
1	→ DCD (Data Carrier Detect)	1
4	← DTR (Data Terminal Ready)	4
9	→ RI (Ring Indicator)	9

10.9.3 Erasing the Configuration

The following processes erases the configuration held in the IP Office control unit's memory. That include both the current configuration in RAM memory and the backup configuration stored in non-volatile Flash memory. Following this the IP Office will restart with a default configuration.

This process should be performed from a PC with a fixed IP address, directly connected to the IP Office control unit and with the IP Office system disconnected from any network. Following this process, the control unit's IP address will default to 192.168.42.1.

- ⚠ Do not perform any of these processes unless absolutely necessary. The IP Office's configuration settings can be default through Manager using the **File | Advanced | Erase Configuration** command.

1. 

Procedure: Erasing the Configuration via Debug

This process erases the IP Office's configuration settings but does not alter its security settings. It is easier to use than the boot loader method.

- ⚠ **WARNING:** Ensure that you have a backup copy of the IP Office's configuration before performing this action.
- Attach the serial cable between the PC and the DTE port on the IP Office control unit.
- Start the terminal program on your PC. Ensure that it has been setup as listed in [DTE Port Settings](#). Within a HyperTerminal session, the current settings are summarized across the base of the screen.
- Enter **AT** (note upper case). The control unit should respond **OK**.
- Enter **AT-DEBUG**. The control unit should response with the time and date and then **Hello>** to show it is ready to accept commands.
- To erase the current configuration in RAM memory enter **eraseconfig**. The **Hello>** command prompt reappears when the action is completed.
- To erase the backup configuration stored in non-volatile Flash memory enter **erasenvconfig**. The **Hello>** command prompt reappears when the action is completed.
- To reboot the IP Office enter **reboot**. The IP Office will reboot and restart with a defaulted configuration.
- Close the terminal program session.
- Manager can now be used to alter and then upload an old configuration file or receive and edit the control unit's now defaulted configuration.

1. 

Procedure: Erasing the Configuration and Security Settings via the Boot Loader

This process defaults the IP Office security settings and its configurations settings.

- ⚠ **WARNING:** Ensure that you have a backup copy of the IP Office's configuration before performing this action.
- Attach the serial cable between the PC and the DTE port on the IP Office control unit.
- Start the terminal program on your PC. Ensure that it has been setup as listed in [DTE Port Settings](#). Within a HyperTerminal session, the current settings are summarized across the base of the screen.
- Enter **AT** (note upper case). The control unit should respond **OK**.
- Switch off power to the IP Office control unit.
- Power on the control unit while repeatedly pressing the escape key until you get a Loader message. Below is an example. It may be necessary to repeat this several times until you successfully get the loader message.

```
P12 Loader 2.4
CPU Revision 0x0900
```
- Enter **AT** (note upper case). The control unit should respond **OK**.
 - To erase the alarm log enter **AT-X1**.
 - To erase the current configuration in RAM memory enter **AT-X3**. A typical response is **Sector Erases (Config)** followed by a series of **OK** responses.
 - To erase the backup configuration stored in non-volatile Flash memory enter **AT-X2**. A typical response if **Sector 2 Erase (NV Config)** followed by **OK**.
 - IP Office 403 only:** If running an IP Office 403 control unit, enter **AT-X4**.
- Switch power to the control unit off and then back on. Within the terminal program you should see various messages as the control unit performs various start up tasks.
- Close the terminal program session.

10. Manager can now be used to alter and then upload an old configuration file or receive and edit the control unit's now defaulted configuration.

IP Office Default Settings

The following are the basic default configuration settings for an IP Office system.

System	Name	MAC address of the control unit.	
	System Password	password	
	License Server IP Address	255.255.255.255	
LAN*		LAN1	LAN2/WAN
	IP address	192.168.42.1.	192.168.43.1
	IP Mask	255.255.255.0	255.255.255.0
	DHCP Mode	Server	Server
	No of DHCP IP Addresses	200.	200.

*See **Default DHCP/Data Settings** detail below.

- **Extensions and Users**

A user is automatically created for each physical extension port detected in the system. Users are assigned extension numbers starting from 201. User names take the form Extn201, Extn202,

- **Hunt Group**

A single hunt group 200 called Main is created and the first 10 users are placed into that hunt group as members.

- **Incoming Call Routes**

Two default incoming call routes are created. Voice calls are routed to the hunt group Main. Data calls are routed to the RAS user DialIn.

- **Default Short Codes**

IP400 control units are manufactured as either A-Law or U-Law variants. For IP500 control units, A-Law or U-Law variant operation is determined by the IP500 Smart Card installed. Depending on the variant, different sets of short codes are created for the default configuration. Refer to the IP Office Manager application help for full details.

- **Default DHCP/Data Settings**

When a defaulted IP Office control unit is switched on, it requests IP address information from a DHCP Server on the network. This operation will occur whether the LAN cable is plugged in or not.

- If a DHCP server responds within approximately 10 seconds, the control unit defaults to being a DHCP client and uses the IP address information supplied by the DHCP server.
- If no DHCP Server responds, the control unit defaults to being the DHCP server for the LAN using the following settings:
 - For its LAN1 it allocates the IP address 192.168.42.1 and IP Mask 255.255.255.0. It supports 200 DHCP clients using the addresses range 192.168.42.2 and 192.168.42.201, the IP Mask 255.255.255.0 and default gateway address 192.168.42.1 (the Control Unit's LAN1 address).
 - For its LAN2 if supported, it allocates the IP address 192.168.43.1 and IP Mask 255.255.255.0.
 - Note that the IP Office does not check that these addresses are valid and or available on the network.
- This mode of operation will persist for subsequent power ups, until a config save occurs due to one of the following
 - The unit performs its automatic midnight backup.
 - A configuration is merged using IP Office Manager.
 - A soft reboot is performed using IP Office Manager.
 - A software upgrade is performed.

10.9.4 Defaulting Security Settings

The following processes can be used to default the security settings of an IP Office system running IP Office 3.2 or higher.



Procedure: Defaulting Security Settings

This process defaults the IP Office's security settings but does not alter its configuration settings.

1. Attach the serial cable between the PC and the DTE port on the IP Office control unit.
2. Start the terminal program on your PC. Ensure that it has been setup as listed in [DTE Port Settings](#). Within a HyperTerminal session, the current settings are summarized across the base of the screen.
3. Enter AT (note upper case). The control unit should respond OK.
4. Enter AT-SECURITYRESETALL.
5. You will be prompted to confirm the control unit's MAC address before continuing. Enter the address.
6. The control unit will respond OK when the action has been completed.
7. Close the terminal program session.
8. Manager can now be used to receive and edit the control unit's now defaulted security settings.





Procedure: Defaulting the Configuration and Security Settings via the Boot Loader

This process defaults the IP Office security settings and its configurations settings.

1.  **WARNING:** Ensure that you have a backup copy of the IP Office's configuration before performing this action.
2. Attach the serial cable between the PC and the DTE port on the IP Office control unit.
3. Start the terminal program on your PC. Ensure that it has been setup as listed in [DTE Port Settings](#). Within a HyperTerminal session, the current settings are summarized across the base of the screen.
4. Enter AT (note upper case). The control unit should respond OK.
5. Switch off power to the IP Office control unit.
6. Power on the control unit while repeatedly pressing the escape key until you get a Loader message. Below is an example.
 P12 Loader 2.4
 CPU Revision 0x0900
7. Enter AT (note upper case). The control unit should respond OK.
8. To erase the current configuration in RAM memory enter AT-X3. A typical response is Sector Erases (Config) followed by a series of OK responses.
9. To erase the backup configuration stored in non-volatile Flash memory enter AT-X2. A typical response is Sector 2 Erase (NV Config) followed by OK.
 - IP Office 403 only: If running an IP Office 403 control unit, enter AT-X4.
10. Switch power to the control unit off and then back on. Within the terminal program you should see various messages as the control unit performs various start up tasks.
11. Close the terminal program session.
12. Manager can now be used to alter and then upload an old configuration file or receive and edit the control unit's now defaulted configuration.

10.9.5 Erasing the Operational Software

This process should be performed from a PC with a fixed IP address, directly connected to the IP Office control unit and with the IP Office system disconnected from any network. During the process, the control unit's IP address may default to a value in the 192.168.42.1 to 192.168.42.10 range. If this occurs it may be necessary to amend the BOOTP entry in Manager to match the address the system is using.

-  Do not perform any of the following processes unless absolutely necessary. The IP Office software can normally be upgraded through Manager using the File | Advanced | Upgrade command.
-  This process erases the operational software. Before attempting this process you must know the MAC and IP addresses of the system, plus have a backup copy of its configuration and the correct .bin file for the control unit type and level of software.
-  The presence of any firewall blocking TFTP and or BOOTP will cause this process to fail.

1. 
2. 
3. 

Procedure: Erasing the Core Software via Debug

1. Run Manager. In the BOOTP entries, check that there is an entry that matches the MAC Address, IP Address and .bin file used by the system (the first two details can be found in the Module settings in the system's configuration file).
2. If an entry is not present, create a new entry. Then close and restart Manager.
3. Under File | Preferences ensure that Manager is set to 255.255.255.255. Also check that Enable BootP Server is checked.
4. Select View | TFTPLog.
5. Check that the required .bin file is present in Manager's working directory.
6. Attach the serial cable between the PC and the DTE port on the IP Office control unit.
7. Start the terminal program on your PC. Ensure that it has been setup as listed in [DTE Port Settings](#). Within a HyperTerminal session, the current settings are summarized across the base of the screen.
8. Arrange the program windows so that the Terminal program and Manager TFTP Log are visible at the same time.
9. Enter AT (note upper case). The control unit should respond OK.
10. Enter AT-DEBUG. The control unit should response with the time and date and then Hello> to show it is ready to accept commands.
11. To erase the current configuration in RAM memory enter upgrade.
12. The IP Office will erase its current software and then send out a BootP request on the network for new software. Manager will respond and start transferring the software using TFTP.

**Procedure: Erasing the Core Software via the Boot Loader**

1. Run Manager. In the BOOTP entries, check that there is an entry that matches the MAC Address, IP Address and .bin file used by the system (the first two details can be found in the Module settings in the system's configuration file).
2. If an entry is not present, create a new entry. Then close and restart Manager.
3. Under File | Preferences ensure that Manager is set to 255.255.255.255. Also check that Enable BootP Server is checked.
4. Select View | TFTPLog.
5. Check that the required .bin file is present in Manager's working directory.
6. Attach the serial cable between the PC and the DTE port on the IP Office control unit.
7. Start the terminal program on your PC. Ensure that it has been setup as listed in [DTE Port Settings](#). Within a HyperTerminal session, the current settings are summarized across the base of the screen.
8. Arrange the program windows so that the Terminal program and Manager TFTP Log are visible at the same time.
9. Switch off power to the IP Office control unit.
10. Power on the control unit and press the escape key every second until you get a Loader message. Below is an example.
P12 Loader 2.4
CPU Revision 0x0900
11. Enter AT (note upper case). The control unit should respond OK.
12. Enter AT-X. The control unit should respond Multi-Sector Erase.
13. The control unit will now request the .bin file it requires from Manager. This process appears in the TFTPLog.
14. If the file transfers does not appear to be taking place, check that the IP address shown in the TFTPLog matches the BOOTP entry. Adjust the BOOTP entry if necessary.
15. When completed the system will reboot.



Chapter 11.

System Components

11. System Components

11.1 Control Units

11.1.1 IP500

The slots are numbered 1 to 4 from left to right. They can be used in any order. However if the capacity for a particular type of card is exceeded, the card in the rightmost slot will be disabled. The unit must not be used with uncovered slots.

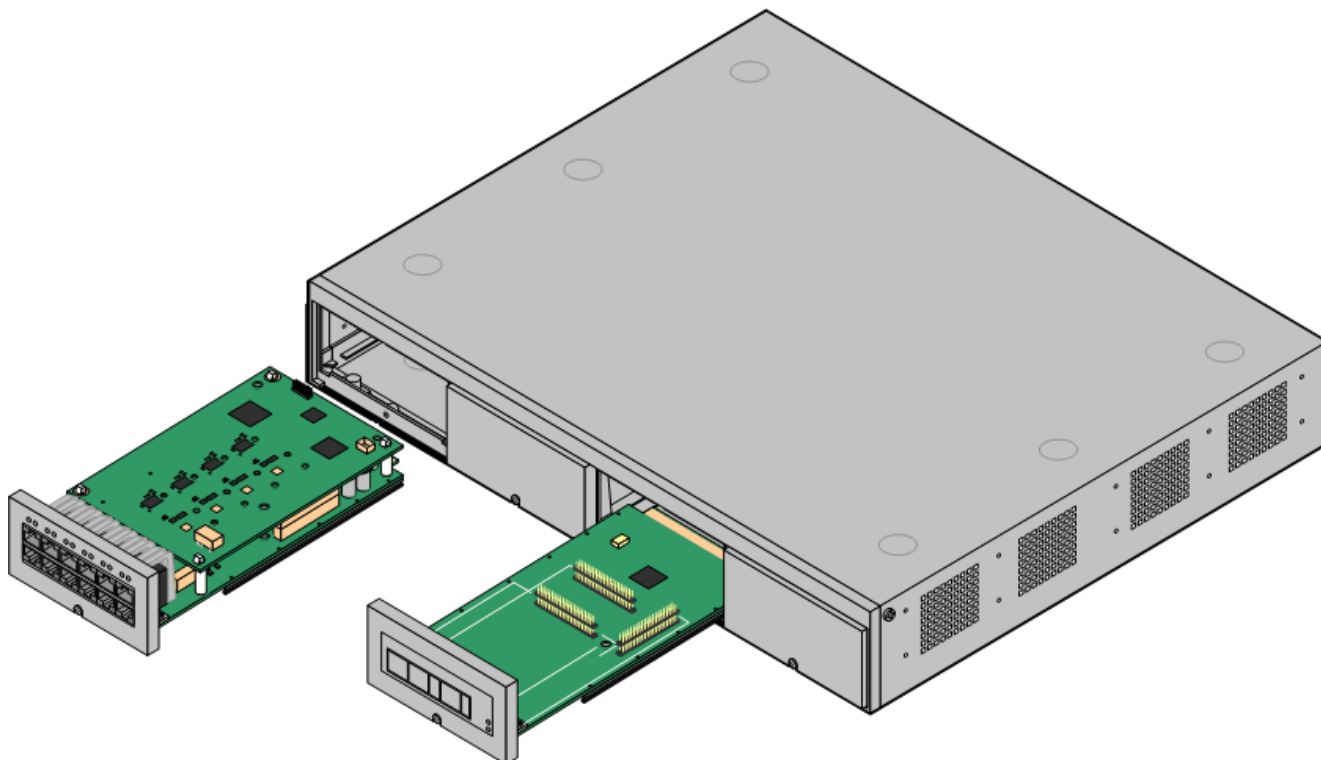

Feature	Capacity
Maximum Extensions	32 using base cards and 32 maximum in IP Office Standard Edition mode. 272 using expansion modules and IP phones in IP Office Profession Edition mode.
Conference Parties	64. Silence suppression is applied to conferences with more than 10 parties.
Trunks Cards	4. Any combination of IP500 trunk daughter cards and up to 2 IP400 trunk cards.
VCM Card Slots	4. Up to a maximum of 128 channels using 2 IP500 VCM cards and or 2 IP400 VCM cards.
Voicemail Channels	Maximum 30 usable for Voicemail Pro/TAPI WAV connection sessions (subject to available licenses).
Locales	Supported in all IP Office locales.
Software Level	<ul style="list-style-type: none">• IP Office core software level 4.0 minimum.• Bin file = ip500.bin.
Power Supply	Internal power supply unit.
Mounting	Free-standing, rack mounted (requires IP500 Rack Mounting Kit) or wall mounted (requires IP500 Wall Mounting Kit).
Dimensions	Width: 445mm/17.5". Depth: 365mm/14.4". Height: 73mm/2.9"/2U. Clearance: 90mm minimum all sides, 220mm at front. 500mm all side when wall mounted.
Memory	Maximum configuration file size: 1024KB.

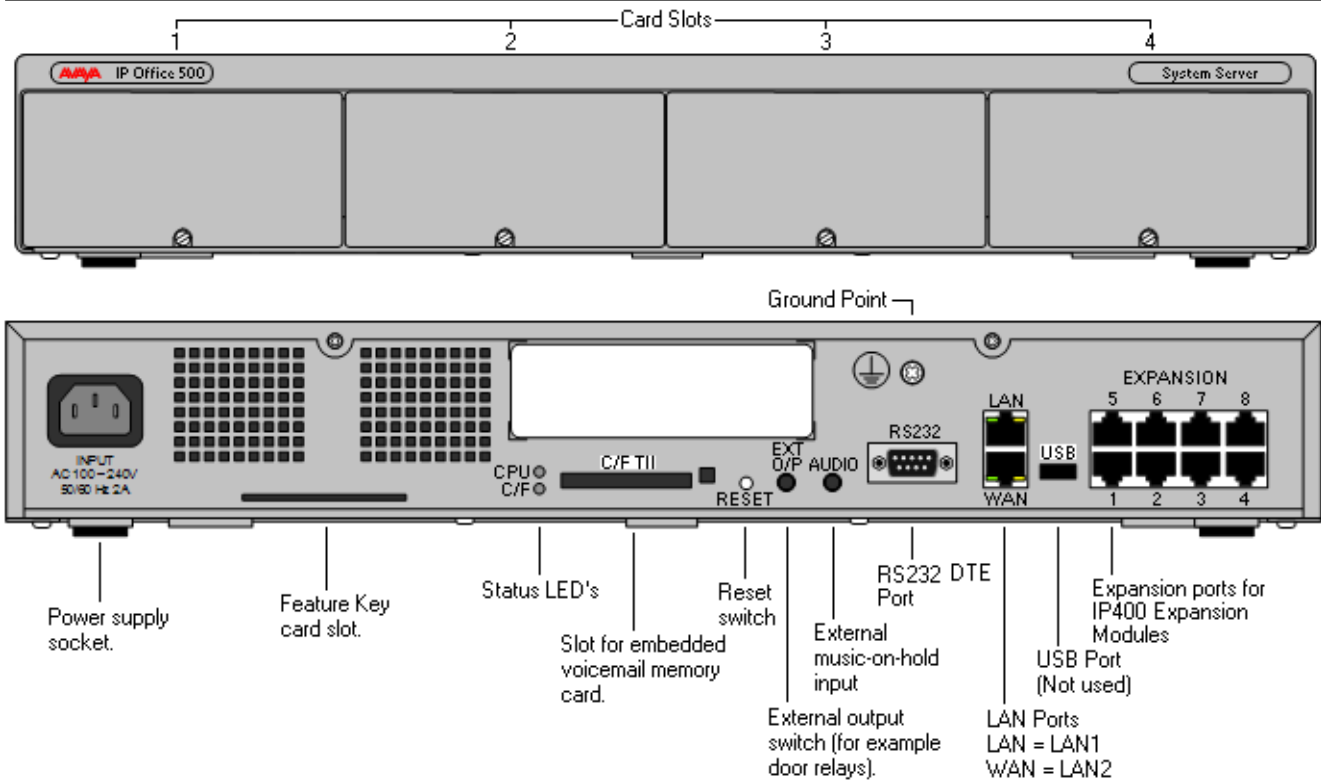

Ports	Description
AUDIO	3.5mm Stereo jack socket. Used for external music on hold source input.
INPUT	DC power input port.
RS232	9-Way D-Type socket. Used for system maintenance.
EXPANSION	RJ45 socket. Used for direct connection to external expansion modules using the Expansion Interconnect cable supplied with the expansion module.
EXT O/P	3.5mm Stereo jack socket. Used for switching external relay systems such as door entry controls. The port contains two independent switches controlled by the IP Office.
LAN	RJ45 sockets. These ports form a managed layer 3 Ethernet switch. The ports are full-duplex 10/100Mbps auto-sensing, MDI crossover ports.
WAN	
	Used for connection of a function or protective ground . Use of a ground for all systems is recommended and for some locales may be a regulatory requirement.

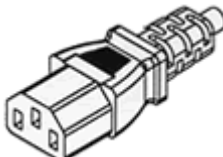
Name	Description	Country	SAP Code
IPO 500 Base Unit	IP Office 500 Base Unit		700417207
Smart Card Feature Key	Smart Card Feature Key (MU-Law)		700417470
	Smart Card feature Key (A-Law)		700417488
 IEC60320 C13 Earthed Power Cord	CEE7/7	Europe	700289762
	BS1363	United Kingdom	700289747
	NEMA5-15P	America	700289770
	China	China	700261977
IP500 Rack Mounting Kit	IP500 Rack Mounting Kit		700429202
IP500 Wall Mounting Kit	IP500 Wall Mounting Kit		700430150
IP500 Blanking Plate Kit	IP500 Blanking Plate Kit		700429194

11.1.2 IP412

The IP412 control unit supports up to 12 Expansion modules. Its LAN ports act as a managed layer 3 Ethernet switch with optional internal firewall for traffic between the two ports.

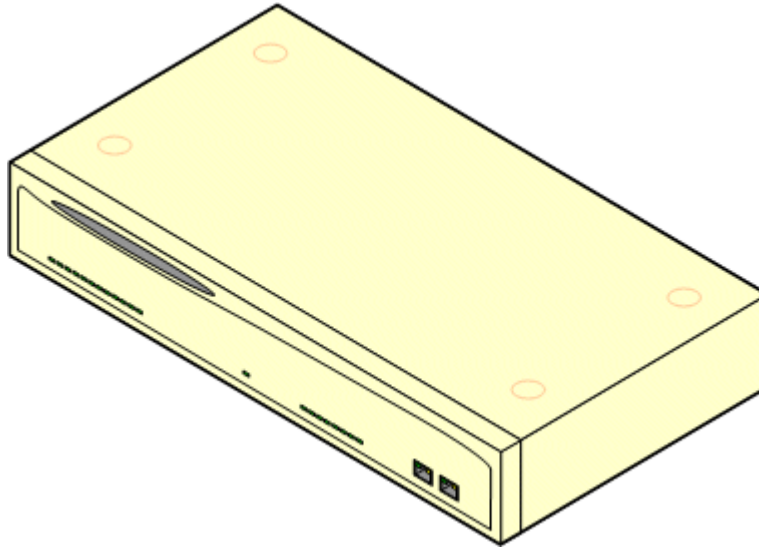

Feature	Capacity
Maximum Extensions	360 of various types in combination. Analog only: 360. DS only: 360. IP only: 360.
Conference Parties	128 (2 banks of 64. Conferences cannot combine resources from both banks. When a conference is started, the bank with the most free resource is used).
Trunks Cards	2 Trunk card slots. All types supported.
VCM Card Slots	2 up to maximum voice compression channels capacity of 60 channels.
Voicemail Channels	30 usable for Voicemail Pro/TAPI WAV connection sessions (subject to available licenses).
Locales	Supported in all IP Office locales.
Software Level	<ul style="list-style-type: none">• IP Office core software level 1.3 minimum.• Bin file = ip412.bin.
Power Supply	<p>The unit is supplied with an earthed 3-Pin, 60W external power supply unit. The PSU has an integral power cord for connection to the unit's DC I/P socket. A locale specific IEC60320 C13 power cord for the external PSU is required but is not supplied with the unit.</p> <ul style="list-style-type: none">• Older units were supplied with a 2-Pin, 40W external power supply unit which used a locale specific locale specific IEC60320 C7 power cord not supplied with the unit.
Mounting	The unit is designed as a free-standing module that can be stacked on or under other IP Office modules. The unit can be rack mounted in a 19" rack system using the optional IP400 Rack Mounting Kit .
Dimensions	Width: 445mm/17.5". Depth: 245mm/9.7". Height: 71mm/2.8"/2U.
Weight	Unboxed: 3.0Kg/6.7lbs. Boxed: 4.3Kg/9.6lbs.
Memory	Maximum configuration file size: 1024KB.

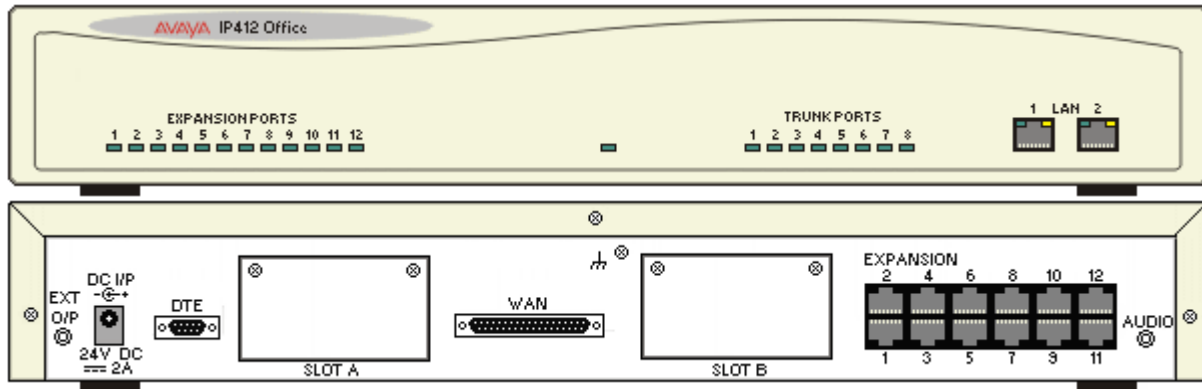

Ports	Description
AUDIO	3.5mm Stereo jack socket. Used for external music on hold source input.
DC I/P	DC power input port. Used for connection of the power lead from an Avaya earthed 60W external power supply unit supplied with the control unit.
DTE	9-Way D-Type socket. Used for system maintenance. Suitable for direct connection of IP Office Serial Port Feature Key dongle.
EXPANSION	RJ45 socket. Used for direct connection to external expansion modules using the Expansion Interconnect cable supplied with the expansion module.
EXT O/P	3.5mm Stereo jack socket. Used for switching external relay systems such as door entry controls. The port contains two independent switches controlled by the IP Office.
LAN	RJ45 socket. These ports form a managed layer 3 Ethernet switch. The ports are half-duplex 10/100Mbps auto-sensing, MDI crossover ports.
SLOT A	Used for trunk cards of all types except WAN port trunk card. Normally Slot B should be used first.
SLOT B	Trunks cards are supplied with replacement external blanking plates suitable for the trunk card port connections.
WAN	37-Way D-Type socket. Used for the connection of V.24, V.35 or X.21 WAN service.
	Used for connection of a function or protective ground . Use of a ground for all systems is recommended and for some locales may be a regulatory requirement. On older modules where this screw is not present, the left-hand fixing screw of Slot B can be used.

All control units are available in either North America or Rest of World variants. The choice controls various default settings of the unit. For E911 support a North American variant control unit must be used. The companding can be changed once a unit is installed. Control units are supplied with an external power supply unit but not a locale specific power cord.

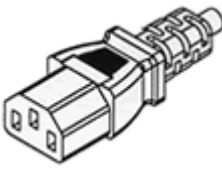
Item	Variant	Country	SAP Code
IP412 Office	A-Law	Rest of World	700234479
	U-Law	North America	700350408
 IEC60320 C13 Power Cord	CEE7/7	Europe	700289762
	BS1363	United Kingdom	700289747
	NEMA5-15P	America	700289770
	China	China	700261977
IP400 Rack Mounting Kit		All	700210800

11.1.3 IP406 V2

The IP406 V2 includes 8 digital station (DS) and 2 analog phone (PHONE) ports. It includes an eight port Ethernet LAN switch (unmanaged Layer 2) and Compact Flash card slot for an optional embedded voicemail memory card. It supports up to 6 external expansion modules plus IP extensions controlled through its LAN interface.

The IP406 V2 also includes automatic gain control (AGC) on its conference chip and performs IPSec tunneling through hardware rather than software.

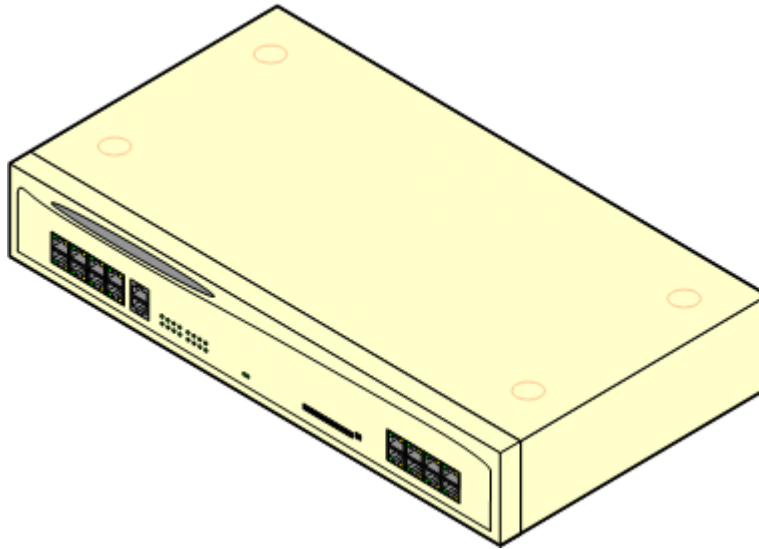

Feature	Capacity
Maximum Extensions	190 of various types in combination. Analog only: 182. DS only: 188. IP only: 190.
Conference Parties	64. Conference chip includes automatic gain control (AGC).
Trunks Cards	2 Trunk card slots. All types supported. Dual PRI trunk cards in Slot A only.
VCM Card Slots	1 up to maximum voice compression channels capacity of 30 channels.
Voicemail Channels	Maximum 20 usable for Voicemail Pro/TAPI WAV connection sessions (subject to available licenses).
Locales	Supported in all IP Office locales.
Software Level	<ul style="list-style-type: none">IP Office core software level 2.1(27) minimum.Bin file = ip406u.bin.
Power Supply	The unit is supplied with an earthed 3-Pin, 60W external power supply unit. The PSU has an integral power cord for connection to the unit's DC I/P socket. A locale specific IEC60320 C13 power cord for the external PSU is required but is not supplied with the unit.
Mounting	The unit is designed as a free-standing module that can be stacked on or under other IP Office modules. The unit can be rack mounted in a 19" rack system using the optional IP400 Rack Mounting Kit .
Dimensions	Width: 445mm/17.5". Depth: 245mm/9.7". Height: 71mm/2.8"/2U.
Weight	Unboxed: 3.0Kg/6.7lbs. Boxed: 4.3Kg/9.6lbs.
Memory	Maximum configuration file size: 256KB.

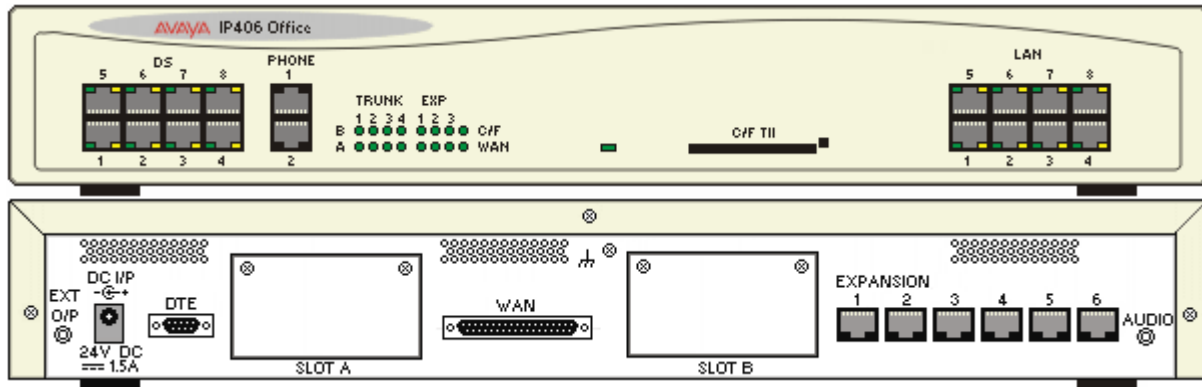

Ports	Description
AUDIO	3.5mm Stereo jack socket. Used for external music on hold source input.
C/F TII	Type 2 Compact Flash socket. Used for optional embedded voicemail card.
DC I/P	DC power input port. Used for connection of the power lead from an Avaya un-earthed 45W external power supply unit supplied with the control unit.
DS	RJ45 socket. Digital Station port. Used for connection of IP Office supported DS phones . Not suitable for out-of-building connections.
DTE	9-Way D-Type socket. Used for system maintenance. Suitable for direct connection of IP Office Serial Port Feature Key dongle.
EXPANSION	RJ45 socket. Used for direct connection to external expansion modules using the Expansion Interconnect cable supplied with the expansion module.
EXT O/P	3.5mm Stereo jack socket. Used for switching external relay systems such as door entry controls. The port contains two independent switches controlled by the IP Office.
LAN	These ports form an unmanaged layer 2 Ethernet switch. The ports are full-duplex 10/100Mbps auto-sensing, auto-MDI/MDIX.
PHONE	Used for connection of analog phones. Not suitable for out-of-building connections. Four-wire analog phones should be connected via a master socket containing ringing capacitors.
SLOT A	Used for trunk cards of all types except WAN port trunk card. Normally Slot B should be used first. Dual PRI trunk cards supported in Slot A only. Trunks cards are supplied with replacement external blanking plates suitable for the trunk card port connections.
SLOT B	
WAN	37-Way D-Type socket. Used for the connection of V.24, V.35 or X.21 WAN service.
	Used for connection of a function or protective ground . Use of a ground for all systems is recommended and for some locales may be a regulatory requirement.

All control units are available in either North America or Rest of World variants. The choice controls various default settings of the unit. For E911 support a North American variant control unit must be used. The companding can be changed once a unit is installed.

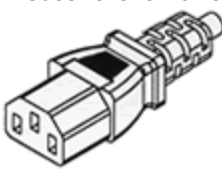
Item	Variant	Country	SAP Code
IP406 V2 Office DS.	A-Law	Rest of World	700343536
	U-Law	North America	700359946
 IEC60320 C13 Power Cord	CEE7/7	Europe	700289762
	BS1363	United Kingdom	700289747
	NEMA5-15P	America	700289770
	China	China	700261977
IP400 Rack Mounting Kit		All	700210800

Control units are supplied with an external power supply unit but not a locale specific power cord.

11.1.4 IP406 V1

This section is included for maintainer information only. This unit is not supported on IP Office 4.0 and higher.

IP406 Office control unit supports up to 180 extensions by using up to 6 Expansion modules. It includes an eight port 10/100Mbps Ethernet LAN hub. The IP406 V1 has been superseded by the IP406 V2 control unit.

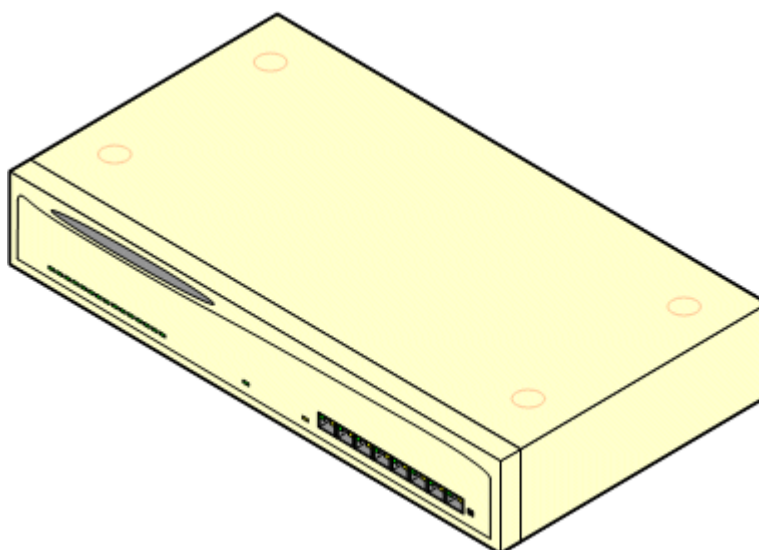

Feature	Capacity
Maximum Extensions	180 of various types in combination. Analog only: 180. DS only: 180. IP only: 180.
Conference Parties	64.
Trunks Cards	2 Trunk card slots. All types supported except Dual PRI trunk cards.
VCM Card Slots	1 up to maximum voice compression channels capacity of 20 channels.
Data Channels	24 of which 20 usable for Voicemail Pro/TAPI WAV connection sessions (subject to available Voicemail Pro Port and TAPI WAV licenses).
Locales	Supported in all IP Office locales.
Software Level	<ul style="list-style-type: none"> IP Office core software level 2.1(27) minimum to 3.2 maximum. Bin file = ip406.bin.
Power Supply	The unit is supplied with a 2-Pin, 40W external power supply unit. The PSU has an integral power cord for connection to the unit's DC I/P socket. A locale specific IEC60320 C7 power cord for the external PSU is required but is not supplied with the unit.
Mounting	The unit is designed as a free-standing module that can be stacked on or under other IP Office modules. The unit can be rack mounted in a 19" rack system using the optional Rack Mounting Kit.
Dimensions	Width: 445mm/17.5". Depth: 245mm/9.7". Height: 71mm/2.8".
Weight	Unboxed: 3.0Kg/6.6lbs. Boxed: 4.3Kg/9.6lbs.
Maximum Configuration Size	192KB.

IP406 V1 Connections

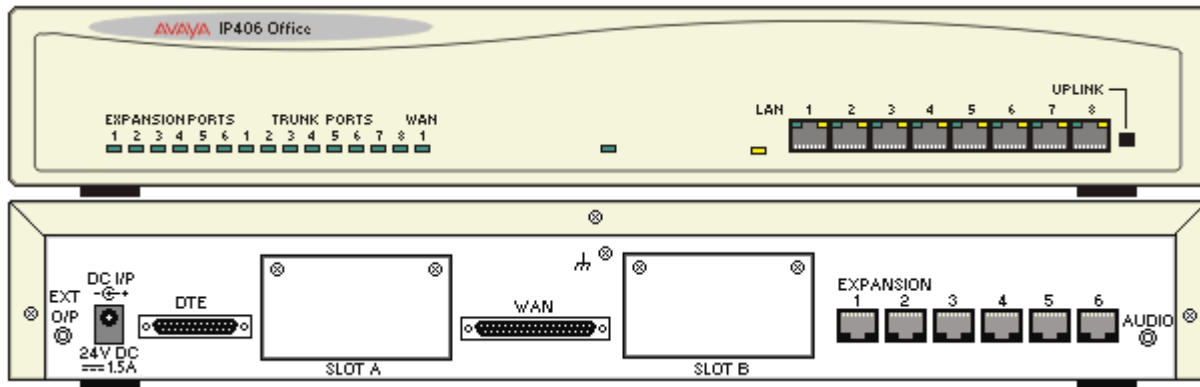

Ports	Description
AUDIO	3.5mm Stereo jack socket. Used for external music on hold source input.
DC I/P	DC power input port. Used for connection of the power lead from an Avaya earthed 60W external power supply unit supplied with the control unit.
DTE	9-Way D-Type socket. Used for system maintenance. Suitable for direct connection of IP Office Serial Port Feature Key dongle.
EXPANSION	RJ45 Socket. Used for direct connection to external expansion modules using the Expansion Interconnect cable supplied with the expansion module.
EXT O/P	3.5mm Stereo jack socket. Used for switching external relay systems such as door entry controls. The port contains two independent switches controlled by the IP Office.
LAN	These ports form an Ethernet hub. The ports are half-duplex 10/100Mbps auto-sensing. Port 8 can be switched from MDIX standard LAN to MDI crossover operation using the UPLINK button on the control unit (In = MDIX, Out = MDI).
SLOT A	Used for trunk cards of all types except Dual PRI trunk cards. Normally Slot B should be used first. Trunks cards are supplied with replacement external blanking plates suitable for the trunk card port connections.
SLOT B	
WAN	37-Way D-Type socket. Used for the connection of V.24, V.35 or X.21 WAN service.
	Used for connection of a function or protective ground. Use of a ground for all systems is recommended and for some locales may be a regulatory requirement. On older modules where this screw is not present, the left-hand fixing screw of Slot B can be used.

All control units are available in either North America or Rest of World variants. The choice controls various default settings of the unit. For E911 support a North American variant control unit must be used. The companding can be changed once a unit is installed.

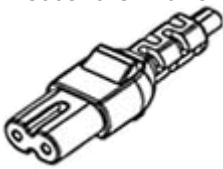
Item	Variant	Country	SAP Code
IP406 V1 Office	A-Law	Rest of World	700234461
	U-Law	North America	700210776
 IEC60320 C7 Power Cord	CEE7/16	Europe	700213382
	BS1363	United Kingdom	700213374
	NEMA1-15	America	700213390
	Korea	Korea	700254519
	China	China	700314172
Rack Mounting Kit		All	700210800

11.1.5 IP403

This section is included for maintainer information only. This unit is not supported on IP Office 4.0 and higher.

The front panel of the IP403 control unit includes eight digital extension (DS) ports, two analog phone (POT) ports and an eight port 10/100Mbps Ethernet LAN hub. The IP403 has been superseded by the IP406 V2 control unit. IP403 control units with integral DT rather than DS ports are also supported up to 3.2, however use of devices on those ports is not supported.

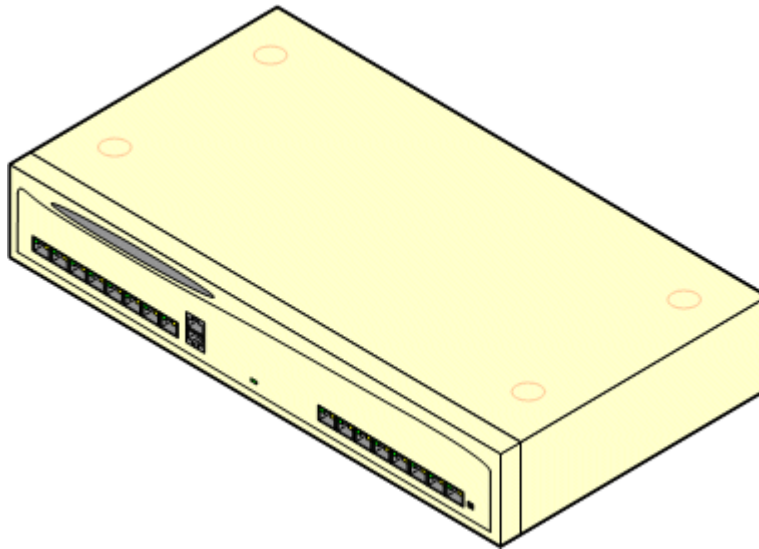

Feature	Capacity
Maximum Extensions	100 of various types in combination. Analog only: 92. DS only: 98. IP only: 100.
Conference Parties	64.
Trunks Cards	2 Trunk card slots. All types supported except Dual PRI trunk cards.
VCM Card Slots	1 up to maximum voice compression channels capacity of 20 channels.
Data Channels	20 of which 10 usable for Voicemail Pro/TAPI WAV connection sessions (subject to available Voicemail Pro Port and TAPI WAV licenses).
Locales	Supported in all IP Office locales.
Software Level	<ul style="list-style-type: none"> IP Office core software level 1.0 minimum. Bin file = ip403.bin. DT Port Support: IP Office 3.0 and higher software does not support the use of DT ports. IP403 DT modules are supported on IP Office 3.0 but use of the integral DT ports is not supported.
Power Supply	The unit is supplied with a 2-Pin, 40W external power supply unit. The PSU has an integral power cord for connection to the unit's DC I/P socket. A locale specific IEC60320 C7 power cord for the external PSU is required but is not supplied with the unit.
Mounting	The unit is designed as a free-standing module that can be stacked on or under other IP Office modules. The unit can be rack mounted in a 19" rack system using the optional Rack Mounting Kit.
Dimensions	Width: 445mm/17.5". Depth: 245mm/9.7". Height: 71mm/2.8".
Weight	Unboxed: 2.5Kg/5.8lbs. Boxed: 3.85Kg/8.6lbs.
Maximum Configuration Size	192KB.

IP403 Connections

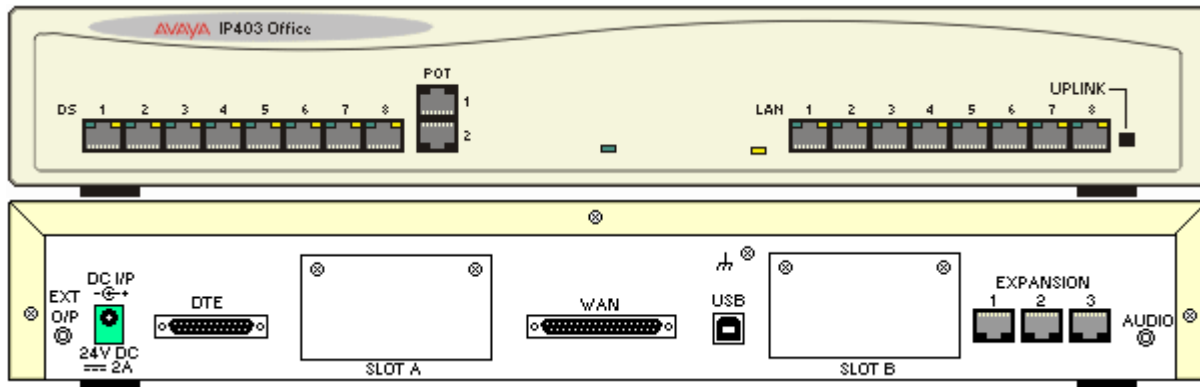

Ports	Description
AUDIO	3.5mm Stereo jack socket. Used for external music on hold source input.
DC I/P	DC power input port. Used for connection of the power lead from an Avaya earthed 60W external power supply unit supplied with the control unit.
DS	RJ45 Socket. Digital Station port. Used for connection of IP Office supported DS phones. Not suitable for out-of-building connections.
DTE	9-Way D-Type socket. Used for system maintenance. Suitable for direct connection of IP Office Serial Port Feature Key dongle.
EXPANSION	RJ45 Socket. Used for direct connection to external expansion modules using the Expansion Interconnect cable supplied with the expansion module.
EXT O/P	3.5mm Stereo jack socket. Used for switching external relay systems such as door entry controls. The port contains two independent switches controlled by the IP Office.
LAN	These ports form an Ethernet hub. The ports are half-duplex 10/100Mbps auto-sensing. Port 8 can be switched from MDIX standard LAN to MDI crossover operation using the UPLINK button on the control unit (In = MDIX, Out = MDI).
POT	Used for connection of analog phones. Not suitable for out-of-building connections.
SLOT A	Used for trunk cards of all types except Dual PRI trunk cards. Normally Slot B should be used first. Trunks cards are supplied with replacement external blanking plates suitable for the trunk card port connections.
SLOT B	
USB	Not used.
WAN	37-Way D-Type socket. Used for the connection of V.24, V.35 or X.21 WAN service.
	Used for connection of a function or protective ground. Use of a ground for all systems is recommended and for some locales may be a regulatory requirement. On older modules where this screw is not present, the left-hand fixing screw of Slot B can be used.

All control units are available in either North America or Rest of World variants. The choice controls various default settings of the unit. For E911 support a North American variant control unit must be used. The companding can be changed once a unit is installed.

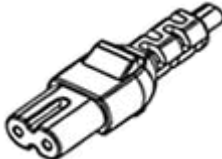
Item	Variant	Country	SAP Code
IP403 Office DS	A-Law	Rest of World	700234453
	U-Law	North America	700350390
 IEC60320 C7 Power Cord	CEE7/16	Europe	700213382
	BS1363	United Kingdom	700213374
	NEMA1-15	America	700213390
	Korea	Korea	700254519
	China	China	700314172
Rack Mounting Kit		All	700210800

Control units are supplied with an external power supply unit but not a locale specific power cord.

11.1.6 Small Office Edition (SOE)

The IP Office Small Office Edition control unit shares many of the features of the other IP Office control units, however it does not support any expansion modules. Small Office Edition control units include various numbers of integral DS, PHONE (POT) and Analog ports.

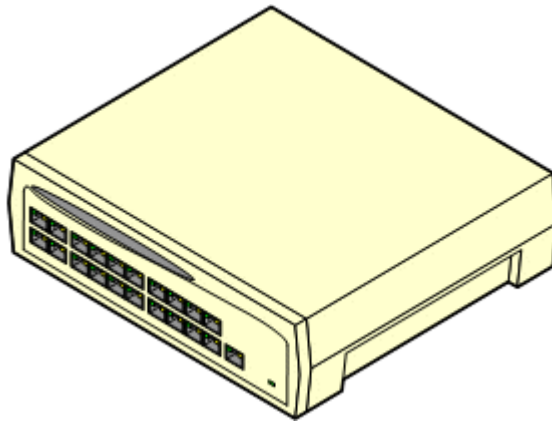

Small Office Edition Model	Analog Trunks	Analog Extensions	Digital Stations	Voice Compression Channels
2T+4A (3 VoIP)	2	4	0	3
4T+8A (3 VoIP)	4	8	0	3
4T+4A+8DS (3 VoIP)	4	4	8	3
4T+4A+8DS (16 VoIP)	4	4	8	16

These models are still supported but are no longer available from Avaya. Previous models that included integral DT ports are not supported on IP Office 3.0 or higher.

Feature	Capacity
Maximum Extensions	28 of various types in combination. Analog only: 4. DS only: 8. IP only: 16.
Conference Parties	21 with a maximum of 8 parties in any particular conference.
Trunks Cards	1 Trunk card slot for ATM4, Quad BRI, Single T1 PRI or single WAN port trunk cards. Sections of the rear panel are removable to provide cable connection to the installed trunk card. For the WAN port card a complete replacement back panel is provided.
VCM Card Slots	None. Either 3 or 16 voice compression channels are pre-built into the module.
Voicemail Channels	Maximum 10 usable for Voicemail Pro/TAPI WAV connection sessions (subject to licenses).
Locales	Supported in all IP Office locales.
Software Level	<ul style="list-style-type: none"> IP Office core software level 2.0 minimum. Bin file = ip401ng.bin.
Power Supply	The unit is supplied with a 3-Pin 45W external power supply unit. The PSU has an integral power cord for connection to the module's DC I/P socket. A locale specific IEC60320 C13 power cord for the external PSU is required but is not supplied with the unit.
Mounting	The unit is designed as a free-standing module that can also be wall mounted via fixing brackets in the base.
Dimensions	Width: 255mm/10.0". Depth: 241mm/9.5". Height: 76mm/3.0".
Weight	Unboxed: 1.2Kg/2.64lbs. Boxed: 2.17Kg/4.77lbs.
Memory	Maximum configuration file size: 192KB.

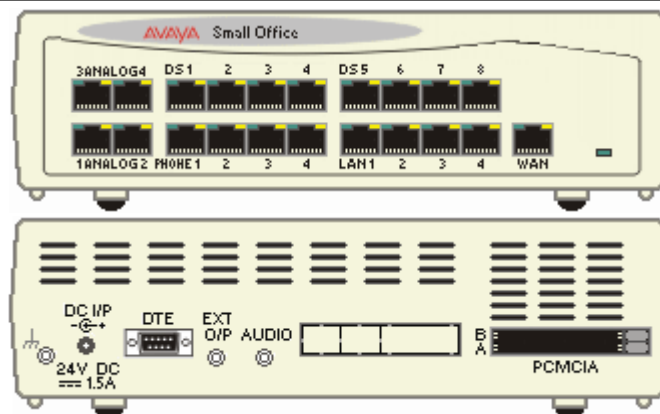

Ports	Description
AUDIO	3.5mm Stereo jack socket. Used for external music on hold source input.
ANALOG	Used for connection of external analog trunks. Loop-start only.
DC I/P	DC power input port. Used for connection of the power lead from an Avaya earthed 60W external power supply unit supplied with the control unit.
DS	Digital Station port. Used for connection of IP Office supported DS phones . Not suitable for out-of-building extensions.
DTE	9-Way D-Type socket. Used for system maintenance. Suitable for direct connection of IP Office Serial Port Feature Key dongle.
EXT O/P	3.5mm Stereo jack socket. Used for switching external relay systems such as door entry controls. The port contains two independent switches controlled by the IP Office.
LAN	RJ45 socket. These ports form an unmanaged layer 2 Ethernet switch. The ports are full-duplex 10/100Mbps auto-sensing, auto-MDI/MDIX ports.
PCMCIA	Dual PCMCIA card slot. Used for optional Embedded Voicemail card and wireless access point card. Cards are not hot-swappable and order of slot usage is not significant.
PHONE	RJ45 socket. Used for connection of analog phones. Intended for two-wire analog phones. For connection to 4-wire analog phones connection should be via a master socket with ringing capacitors. During power failure, PHONE port 1 is directly connected to ANALOG trunk port 2. Not suitable for out-of-building connections. <ul style="list-style-type: none"> On some older Small Office Edition control units, these ports are labeled as POT rather than PHONE.
WAN	RJ45 socket. 10/100Mbps Ethernet LAN port. Acts as LAN2 within the configuration.
	3.5mm Jack socket. Function ground point. Used for connection of a function or protective ground . Use of a ground for all systems is recommended and for some locales may be a regulatory requirement.

All control units are available in either North America or Rest of World variants. The choice controls various default settings of the unit. For E911 support a North American variant control unit must be used. The companding can be changed once a unit is installed.

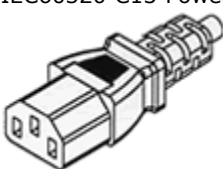
Item	Variant	Country	SAP Code
Small Office Edition 4T+4A+8DS (3 VoIP)	A-Law	Rest of World	700280209
	U-Law	North America	700350424
Small Office Edition 4T+4A+8DS (16 VoIP)	A-Law	Rest of World	700280217
	U-Law	North America	700350432
 IEC60320 C13 Power Cord	CEE7/7	Europe	700289762
	BS1363	United Kingdom	700289747
	NEMA5-15P	America	700289770
	China	China	700261977
Rack Mounting Kit		All	700210800

Control units are supplied with an external power supply unit but not a locale specific power cord.

11.2 Internal Cards

11.2.1 Modem Cards

A modem card allows the IP Office to answer incoming modem calls up to V.90. There are two variants of modem card available:

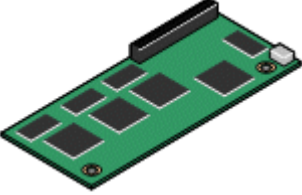
Variants	Country	SOE	IP406 V2	IP412	IP500	SAP Code
 <p>Modem 2 Card Provides 2 modem channels. Supported from IP Office 1.0 onwards.</p>	All	✗	✓	✓	✗	700185226
<p>Internal Modem Card Provides 12 modem channels except on the IP403 where it only provides 4. Supported from IP Office 2.1(27) onwards.</p>	All	✗	✓	✓	✗	700343452

- The cards are supplied with 2 plastic stand off pillars for installation.
- The first analog trunk on Small Office Edition control units and on modules fitted with an ATM4 or ATM4U trunk card, can be set to answer V.32 analog modem calls. Whilst in this mode, the trunk cannot be used for voice calls.

11.2.2 Wireless Card

This card is supported by the Small Office Edition control unit only and allows the unit to act as an 802.11b wireless access point. The card can be inserted into either of the control units two PCMCIA slots.

- ⚠ These cards are not hot swappable. Removal of the card while the IP Office control unit is powered is not recommended.

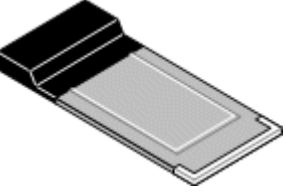

Wireless Card	Country	SOE	IP406 V2	IP412	IP500	SAP Code
 <p>Small Office Edition Wireless Card</p> <ul style="list-style-type: none"> • Use of the card requires entry of a Small Office WiFi license (IP400 WiFi Access Point RFA) into the IP Office configuration. 	All	✓	✗	✗	✗	700289739

11.2.3 Embedded Voicemail Memory Cards

These cards are supported on the Small Office Edition and the IP406 V2 control units. They are specially formatted Compact Flash cards that provide embedded voicemail operation and can also be configured for basic auto-attendant support.

Use of these cards for voicemail does not require a license.

- ⚠ These cards are not hot swappable. Removal of the cards while the IP Office control unit is powered may cause lose or corruption of messages and prompts.

Variant		Country	SOE	IP406 V2	IP412	IP500	SAP Code
	Small Office Edition Uses a 64MB Compact Flash cards fitted into a PCMCIA slot caddy. The card provides up to 10 hours storage for compressed prompts, greetings and messages. Operation of the card uses the one of the Small Office's voice compression channels for each call.	All	✓	✗	✗	✗	700289721
	IP406 V2 Uses a 512MB Compact Flash card. This card provides up to 15 hours storage for uncompressed prompts, greetings and messages. Operation of this card does not require voice compression channels.	All	✗	✓	✗	✓	700343460

- From IP Office 3.0 onwards, the prompt files for the following languages are pre-installed on the Avaya memory cards.

- Danish
- German
- English-UK
- English-US
- Spanish
- Spanish-Mexico
- Spanish-Argentina
- Finnish
- French
- French-Canadian
- Italian
- Korean
- Dutch
- Norwegian
- Portuguese
- Portuguese-Brazilian
- Russian
- Swedish
- Chinese - Mandarin
- Chinese- Cantonese (*IP Office 4.2 +*)

- For full details of embedded voicemail setup and configuration, refer to the Embedded Voicemail Installation manual.
- Memory cards in these slots can also be used for storage of files normally obtained via TFTP transfer. For example the music-on-hold wav file and supported 4600 Series/5600 Series software files. This will however reduce storage space for prompt and message files if embedded voicemail is being used. Non-Avaya memory cards can be used for this function.

11.2.4 Voice Compression Modules

VCM's are optional cards that can be installed inside all IP Office system control units except the Small Office Edition. Each VCM provides a number of voice compression channels, indicated by a number suffix. For example, a VCM 8 has 8 voice compression channels.

- Small Office Edition control units have either 3 or 16 built in voice compression channels with 40mms echo cancellation.

VCM Cards		SAP Code	Small Office Edition	IP406 V2	IP412	IP500
25ms echo cancellation.	VCM5*	700185119	✗	✓	✓	✗
	VCM10*	700185127	✗	✓	✓	✗
	VCM20*	700185135	✗	✓	✓	✗
	VCM30	700293939	✗	✓	✓	✓
64ms echo cancellation.	VCM4	700359854	✗	✓	✓	✓
	VCM8	700359862	✗	✓	✓	✓
	VCM16	700359870	✗	✓	✓	✓
	VCM24	700359888	✗	✓	✓	✓
Number of VCM cards.			0	1	2	2
Maximum number of channels.			3/16	30	60	128

- Support for VCM 20 on IP403 was added at IP Office 1.3
- *These modules are still supported on some systems but are no longer available from Avaya.
- For the IP500 control unit an IP500 Carrier Card is required, up to a maximum of 2 carrier cards. Channels can also be added using up to 2 IP500 VCM base cards with VCM licenses.

11.3 IP400 Trunks Cards

11.3.1 Analog Trunk Card Uni (ATM4U)

This card supersedes the previous Analog Trunk cards and is referred to as the "ATM4U". It can be identified by a label on the base of the card.

The card is supported on IP Office software 2.1(36) and higher. Unlike the previous ATM4 card, the same ATM4U card variant can be used in all locales.

For systems running IP Office software 3.1 or higher, the echo cancellation used on each trunk can be switched off or on (16ms).

The card provides 4 RJ45 sockets for [analog trunk connections](#). The card only supports loop-start trunks. For ground-start trunks an [Analog Trunk expansion module](#) should be used.

- **Power Failure Operation**

There are no power failure extension connections provided for the analog trunk card. If this is a requirement, the ATM16 expansion module should be used.

- **⚠ WARNING**

In all IP Office installations, any module or control unit using analog trunk connections must be connected to a [functional earth](#).

- **⚠ WARNING**

Within the Republic of South Africa and in areas of high lightning risk, any module or control unit using analog trunk connections must be connected to a [protective ground](#) and to [surge protection equipment](#).

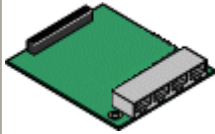
ATM4U Trunk Card		Country	SAP Code	SOE	IP406 V2	IP412	IP500
	ATM4 Uni (Loop-Start)	All	700359938	✗	✓	✓	✓

- The card include two plastic stand off pillars for installation and a replacement blanking plate for the rear of IP400 control units.
- For the IP500 control unit an IP500 Carrier Card is required, up to a maximum of 2 carrier cards.

11.3.2 Analog Trunk Cards (ATM4)

The Analog Trunk card is also referred to as the "ATM4". It provides 4 RJ45 sockets for [analog trunk connections](#). The card only supports loop-start trunks.

The card is available in a number of locale specific variants as detailed below.

- **Power Failure Operation**

There are no power failure extension connections provided for the analog trunk card.

-  **WARNING**

In all IP Office installations, any module or control unit using analog trunk connections must be connected to a [functional earth](#).

-  **WARNING**

Within the Republic of South Africa and in areas of high lightning risk, any module or control unit using analog trunk connections must be connected to a [protective ground](#) and to [surge protection equipment](#).

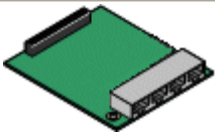
ATM4 Trunk Cards		Country	SAP Code	SOE	IP406 V2	IP412	IP500
	IP400 Analog 4 (Loop-Start)	North and South America	700185192	✗	✓	✓	✗
	IP400 Analog 4 EU (Loop-Start)	Europe	700241672	✗	✓	✓	✗
	IP400 Analog 4 NZ (Loop-Start)	New Zealand	700241706	✗	✓	✓	✗

- These cards include two plastic stand off pillars for installation and a replacement blanking plate for the rear of IP400 control units.

11.3.3 BRI Trunk Cards

The BRI trunk card is also referred to as the "Quad BRI". It provides 4 RJ45 sockets for ETSI BRI trunk connections, with each trunk supporting 2B+D channels.

- The trunk card ports include 100 ohm termination.

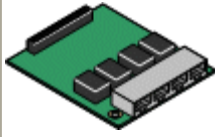
Variant	Country	SAP Code	SOE	IP406 V2	IP412	IP500
	IP400 BRI	All	✓	✓	✓	✓
	IP400 BRI 8 (UNI)	All except China	✓	✓	✓	✓

- These cards include two plastic stand off pillars for installation and a replacement blanking plate for the rear of IP400 control units.
- For the IP500 control unit an IP500 Carrier Card is required, up to a maximum of 2 carrier cards.

11.3.4 T1 PRI Trunk Cards

These trunk cards support 23B+D primary rate (US PRI) trunks and 24B T1 robbed-bit trunks. The mode of operation is selected within the IP Office configuration.

The T1 PRI card includes an integral CSU/DSU that can be activated through the IP Office Monitor application.

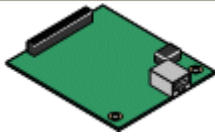
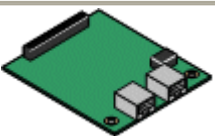
PRI Trunk Cards		Country	SAP Code	SOE	IP406 V2	IP412	IP500
	IP400 PRI 24 T1	North America	700185200	✗	✓	✓	✓
	IP400 PRI 48 T1	North America	700185218	✓	✓	✓	✓

- These cards include two plastic stand off pillars for installation and a replacement blanking plate for the rear of IP400 control units.
- For dual port cards the IP406 V2 only supports a single dual card in Slot A.
- For the IP500 control unit an IP500 Carrier Card is required, up to a maximum of 2 carrier cards.

11.3.5 E1 PRI Trunk Cards

These cards support primary rate trunks providing 30B+D channels.

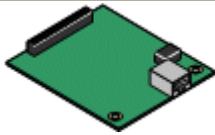
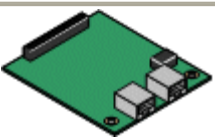
E1 PRI trunk Cards		Country	SAP Code	SOE	IP406 V2	IP412	IP500
	IP400 PRI 30 E1 (1.4)	All except China and CALA.	700272461	✗	✓	✓	✓
	IP400 PRI 60 E1	All except China and CALA.	700185184	✗	✓	✓	✓

- These cards include two plastic stand off pillars for installation and a replacement blanking plate for the rear of IP400 control units.
- For dual port cards the IP406 V2 only supports a single dual card in Slot A.
- For the IP500 control unit an IP500 Carrier Card is required, up to a maximum of 2 carrier cards.

11.3.6 WAN Trunk Card

This trunk card provides a single 37-way D-type [WAN port](#).

WAN Cards	Country	SAP Code	SOE	IP406 V2	IP412	IP500
	IP400 WAN Expansion	All	700289713	✓	✗	✗

- The card is supplied with two plastic stand off pillars for installation and a replacement rear panel for the Small Office Edition control unit.

11.3.7 E1R2 PRI Trunk Cards

These cards support E1 trunks with R2 signalling. Each trunk provides up to 30B+D channels.

E1R2 PRI trunk cards are available with either RJ45 or coaxial cable connectors.

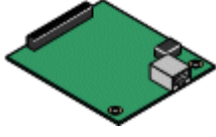
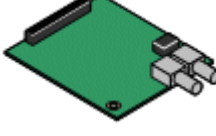
E1R2PRI trunk Cards	Country	SAP Code	SOE	IP406 V2	IP412	IP500
	IP400 PRI 30 E1R2 RJ45	CALA, Korea, China	700241631	✗	✓	✓
	IP400 PRI 60 E1R2 RJ45		700241649	✗	✓	✓
	IP400 PRI 30 E1R2 COAX	CALA	700241656	✗	✓	✗
	IP400 PRI 60 E1R2 COAX		700241664	✗	✓	✗

- These cards include two plastic stand off pillars for installation and a replacement blanking plate for the rear of IP400 control units.
- For E1R2 coaxial card, a ground-jumper cable and coaxial connector locking rings are included.
- For dual port cards the IP406 V2 only supports a single dual card in Slot A.
- For the IP500 control unit an IP500 Carrier Card is required, up to a maximum of 2 carrier cards.

E1R2 coax trunk cards must be grounded correctly and require the IP Office control unit to be connected to a protective ground. Normally the ends of one connection is grounded. For example, if the exchange Tx1 is grounded, the IP Office Rx1 should also be grounded. However this must be confirmed with the line provider to establish which ends they want grounded.

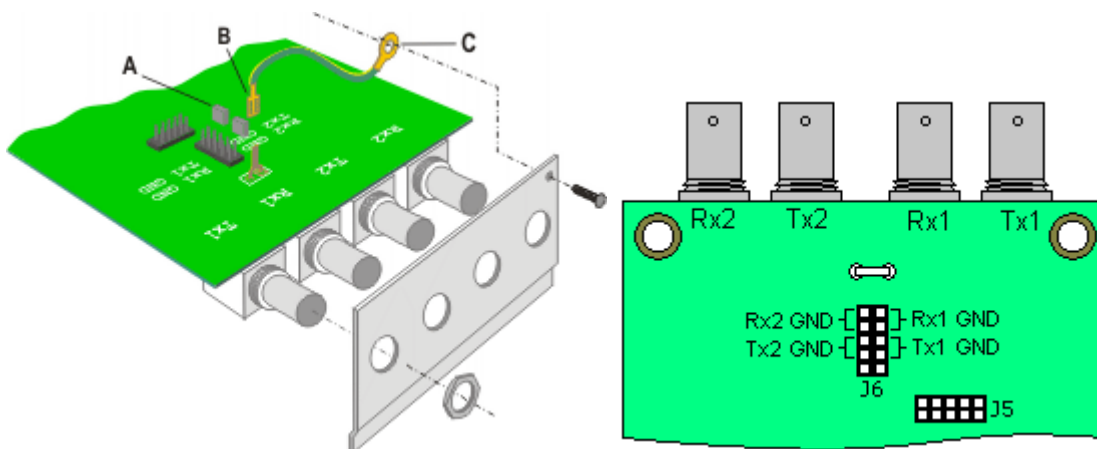

- Connect the ground strap spade end (B) supplied with the card to the spade connection on the card and the other end (C) to the chassis with the long securing screw also supplied with the card.
- Use the two jumpers supplied with the card, match the ground selection of the line provider. For example, if the line provider has grounded their Tx1, place a jumper across the two Rx1 pins of jumper block J6.

11.4 IP500 Base Cards

11.4.1 Legacy Card Carrier

The IP500 Legacy Card Carrier base card can be used to fit IP Office IP400 cards into the IP500 control unit. This can include IP400 trunk and IP400 VCM cards. Up to 2 Legacy Card Carrier cards are supported in an IP500 control unit.

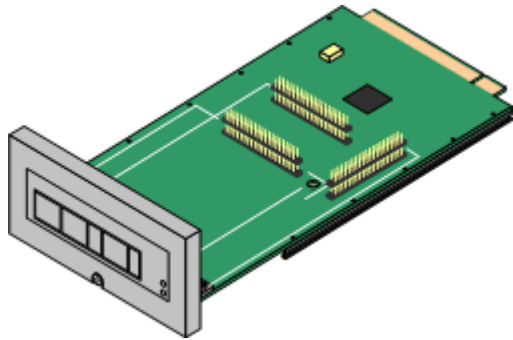

- Maximum per IP500 Control Unit: 2.
- IP500 Daughter Card Support: **X**.
- IP400 Card Support:
 - ✓ PRI T1
 - ✓ BRI-8 (UNI)
 - ✓ Dual PRI T1
 - ✓ ANLG 4 Uni (US only)
 - ✓ PRI 30 E1 (1.4)
 - ✓ VCM 4
 - ✓ Dual PRI E1
 - ✓ VCM 8
 - ✓ PRI 30 E1R2 RJ45
 - ✓ VCM 16
 - ✓ Dual PRI E1R2 RJ45
 - ✓ VCM 24
 - ✓ VCM 30

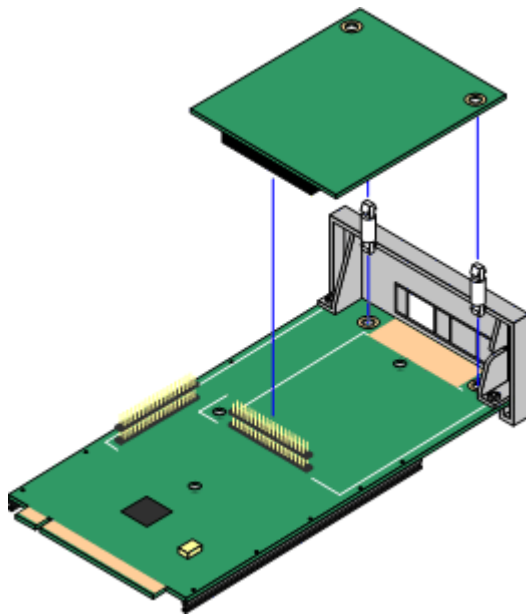

- Cards not listed are not supported.

Name	Description	SAP Code
IPO 500 Carrier Card	IP Office 500 Carrier Card	700417215

Panels on the front of the carrier card can be snapped off to match the port connects when fitting an IP500 trunk card.

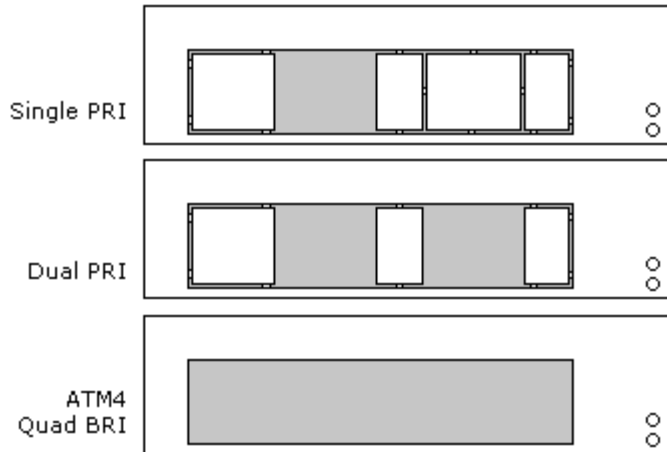

11.4.2 VCM

This type of card is used to add voice compression channels to the IP500 control unit. Those channels are used for VoIP calls including IP extensions and or IP trunks.

The IP500 VCM card is available in two variants; 32 channels and 64 channels. Each card provides 4 unlicensed VCM channels. Additional channels are enabled through the use of IP500 VCM licenses.

The IP500 control unit supports up to 128 voice compression channels, using IP500 VCM cards and or IP400 VCM cards on an IP500 carrier card.

Both cards have 4 RJ45 ports for that are used for connections when an IP500 daughter card is fitted.

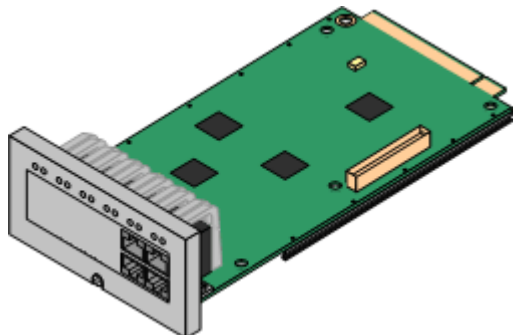

- Codecs: G.711, G.729a and G.723 with 64ms echo cancellation.
- Maximum per IP500 Control Unit: 2.
- IP500 Daughter Card Support: ✓ 1.
- The maximum number of simultaneous channels useable on an IP500 VCM base card is affected by the codec being used. The following table assumes that all calls using the VCM use the same codec.

Codec	IP500 VCM32	IP500 VCM64
G.711	32	64
G.729a	30	60
G.723	22	44

- LEDs 1 to 8 are unlabelled. They are used to indicate voice compression channel usage. Each LED lit represents 12.5% of the available voice compression channel capacity in use (total card capacity rather than licensed capacity).
- LED1 is used for general card status. Flash every 5 seconds = Okay.

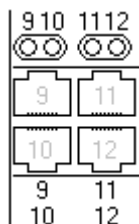

Daughter Card Ports (9-12)
LED use depends daughter card type:

- [IP500 Analog Trunk Card.](#)
- [IP500 BRI Trunk Card.](#)
- [IP500 PRI Trunk Card.](#)
- LED 9 is also used for daughter card status. Flash every 5 seconds = Okay.

Name	Description	SAP Code
IPO 500 MC VCM 32	IP Office 500 Media Card Voice Coding Module 32	700417389
IPO 500 MC VCM 64	IP Office 500 Media Card Voice Coding Module 64	700417397
IPO LIC IP500 VCM LIC 4 CH	IP500 Addition VCM Channels License: 4 Channels	202961
IPO LIC IP500 VCM LIC 8 CH	IP500 Addition VCM Channels License: 8 Channels	202962
IPO LIC IP500 VCM LIC 16 CH	IP500 Addition VCM Channels License: 16 Channels	202963
IPO LIC IP500 VCM LIC 28 CH	IP500 Addition VCM Channels License: 28 Channels	202964
IPO LIC IP500 VCM LIC 60 CH	IP500 Addition VCM Channels License: 60 Channels	202965

11.4.3 Digital Station

This card is used to add digital station (DS) extension ports to the IP500 control unit. It provides 8 RJ45 DS extension ports for use with Avaya digital phones not including IP phones. A further 4 RJ45 ports are provided for trunk connections when an IP500 trunk card is fitted to this card.

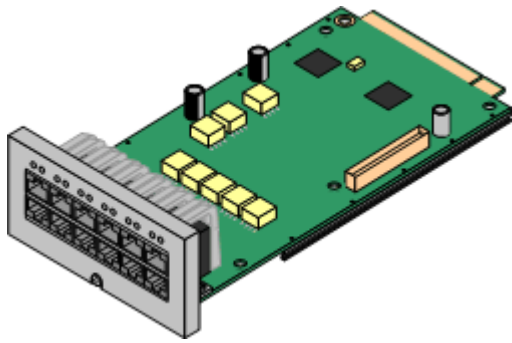

- Provides 8 [DS](#) ports for [digital stations](#) supported (except 4406D, 4412D and 4424D).
- Maximum per IP500 Control Unit: 3.
- IP500 Daughter Card Support: ✓ 1.

Digital Station Ports (1-8)

- Green On - Phone detected.
- LED1 is used for card status:
- Red On - Error
- Red Flashing - Initializing.
- Red Flash every 5 seconds - Okay.

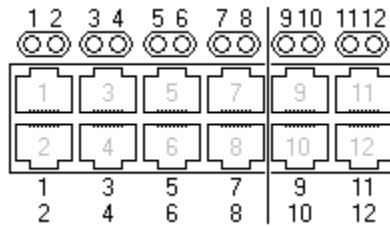

Daughter Card Ports (9-12)

LED use depends daughter card type:

- [IP500 Analog Trunk Card.](#)
- [IP500 BRI Trunk Card.](#)
- [IP500 PRI Trunk Card.](#)
- LED 9 is also used for daughter card status. Flash every 5 seconds = Okay.

Name	Description	SAP Code
IPO 500 Extn Card Dgtl Sta 8	IP Office 500 Extension Card Digital Station 8	700417330

11.4.4 Analog Phone

This card is used to add analog phone extension ports to the IP500 control unit. It is available in two variants, providing either 2 or 8 analog extension ports.

The cards have 8 RJ45 extension ports for use with analog phone devices. A further 4 RJ45 ports are provided for trunk connections when an IP500 trunk card is fitted to this card.

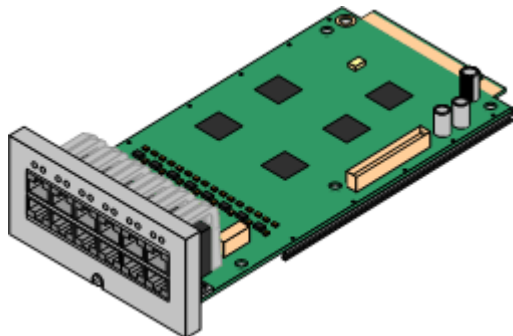

- Provides either 8 or 2 [analog](#) phone ports depending on card variant:
 - Supports ICLID modes DTMFA, DTMFC, DTMFD, FSK and UK20.
 - REN 2 (1 for external bell device).
 - Off-Hook current: 25mA
 - Ring Voltage: 40V.
- Maximum per IP500 Control Unit: 4.
- IP500 Daughter Card Support: ✓ 1.
- The Analog Phone 8 provides a power fail port when fitted with an IP500 Analog Trunk daughter card. During power failure extension port 8 is connected to the analog trunk port 12.
- Intended for connection to two-wire analog phones, the ports do not include a ringing capacitor. For connection to 4-wire analog phones, connection should be via a master socket with ringing capacitors.

Analog Extension Ports (1-8)

- LED1 only is used.
- LED1 is used for card status:
 - Red On - Error
 - Red Flashing - Initializing.
 - Red Flash every 5 seconds - Okay.



Daughter Card Ports (9-12)

LED use depends daughter card type:

- [IP500 Analog Trunk Card.](#)
- [IP500 BRI Trunk Card.](#)
- [IP500 PRI Trunk Card.](#)
- LED 9 is also used for daughter card status. Flash every 5 seconds = Okay.

Name	Description	SAP Code
IPO 500 Extn Card Phone 2	IP Office 500 Extension Card Phone 2	700431778
IPO 500 Extn Card Phone 8	IP Office 500 Extension Card Phone 8	700417231

11.5 IP500 Daughter Cards

11.5.1 Analog Trunk Card

This card can be added to an IP500 base card to provide that card with support for 4 loop-start analog trunks. This card can be fitted to any IP500 base card except the IP500 Carrier base card.

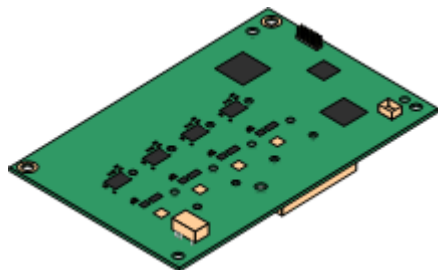

- Ports/Channels
4 Loop-start analog trunk ports. Connections via the host IP500 base card.
- DTMF, ICLID, Busy tone detection.
- Over-voltage and lightning protection (may still require additional protection equipment see [Lightning Protection/Out-of-Building Connections](#)).
- DTMF and LD dialing.
- Adjustable echo cancellation (default 16ms). Selectable to Off, 8, 16, 32, 64 and 128 milliseconds.
- Power Fail Port when fitted to an IP500 Analog Phone 8 base card. During power failure extension port 8 is connected to the analog trunk port 12.
- License: No license required. Supported by IP Office Standard and IP Office Professional Edition modes.
- Maximum per IP500 Control Unit: 4.
- IP Office Software Level: 4.0+.

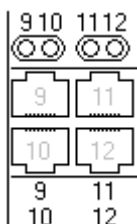

Daughter Card Ports (9-12)

The LED's for ports 9 to 12 of the IP500 base card are used as follows::

- Green on: Card fitted.
- Green flashing: Trunk in use.
- LED 9 is also used for daughter card status. Flash every 5 seconds = Okay.

Name	Description	SAP Code
IPO 500 Trnk Anlg 4 Uni	IP Office 500 Trunk Card Analog 4 Universal	700417405

11.5.2 BRI Trunk Cards

This card can be added to an IP500 base card to provide that card with support for [BRI-To](#) trunks. This card can be fitted to any IP500 base card except the IP500 Carrier base card.

The card is available in 8 channel (4 physical trunks) or 4 channel (2 physical trunks) variants.

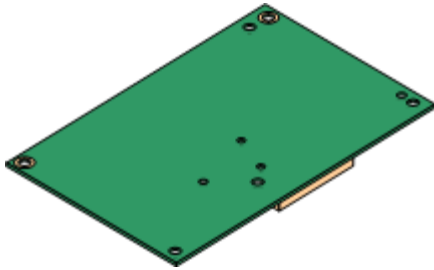

- **Ports/Channels**

2 or 4 BRI trunk ports. Connections via ports 9 to 12 of the host IP500 base card.

- Each trunk port supports 2B+D channels.
- ETSI or AusTS013 basic rate protocol set through the IP Office configuration.
- License: No license required. Supported by IP Office Standard and IP Office Professional Edition modes.
- Maximum per IP500 Control Unit: 4.
- IP Office Software Level: 4.0+.
- S-Bus Connection: On IP Office 4.2+ systems, the card can be switched from [To](#) trunk mode to [So](#) mode. This mode requires additional terminating resistors and an ISDN crossover cable connection, see [BRI Port \(So\)](#).
- This card is approved for use in the following countries:

Brazil.	New Zealand.
China.	Russia.
India.	South Africa.
Argentina.	United Arab Emirates (UAE).
Australia.	European Union (EU).

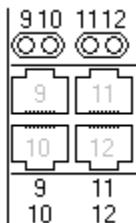

Daughter Card Ports (9-12)

The LED's for ports 9 to 12 of the IP500 base card are used as follows:

- Off: No trunk present.
- Green on: Trunk present.
- Green flashing: Trunk in use.
- LED 9 is also used for daughter card status. Flash every 5 seconds = Okay.

Name	Description	SAP Code
IPO 500 Trnk BRI 4 Uni	IP Office 500 Trunk Card Basic Rate 4 Universal	700417413
IPO 500 Trnk BRI 8 Uni	IP Office 500 Trunk Card Basic Rate 8 Universal	700417421
IPO IP500 BRI S0 CONVTR CBL	IP500 BRI So Converter Cable	700458649

11.5.3 PRI Trunk Cards

This card can be added to an IP500 base card to provide that card with support for PRI trunks. This card can be fitted to any IP500 base card except the IP500 Carrier base card. The card is available in single port or dual port variants.

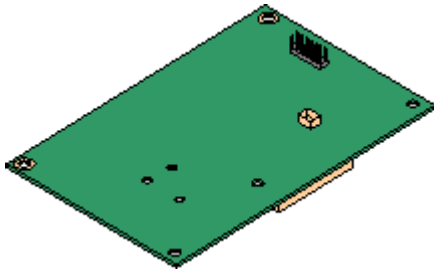

- **Ports/Channels**

1 or 2 [PRI trunk ports](#). Each port supports the following PRI line types. On dual port cards both ports will be the same line type. The line type selection can be changed using IP Office Manager.

- E1 PRI (30B+D channels per port).
- E1R2 PRI (30B channels per port).
- T1 robbed bit (24B channels per port) or T1 PRI (23B+D channels per port).
- When installed in IP500 with a U-Law Feature Key dongle, the card will default T1 PRI mode. When installed in an IP500 with an A-Law Feature Key dongle the card will default to E1 PRI mode. The required mode can be selected within IP Office Manager by right-clicking on the line icon and selecting **Change Universal PRI Card Line Type** and then selecting the required line type.
- Physical trunk connection is via ports 9 and 10 of the host IP500 base card.
- Port 11 and 12 can be used as test points for connection of test and monitoring equipment for the adjacent port.

- **Licenses**

The IP Office system supports 8 unlicensed B-channels on each IP500 PRI-U port fitted. Additional B-channels, up to the capacity of ports installed and PRI mode selected require **IP500 Universal PRI (Additional Channels)** licenses added to the configuration. These additional channels consume the licenses based on which additional channels are configured as in-service from port 9 of slot 1 upwards. D-channels are not affected by licensing.

- Maximum per IP500 Control Unit: 4.
- Software Level: 4.1+.

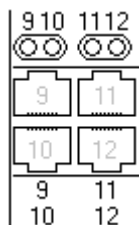

Daughter Card Ports (9-12)

The LED's for ports 9 to 12 of the IP500 base card are used as follows:

- Off: No trunk present.
- Green on: Trunk present.
- Green flashing: Trunk in use.
- Red/Green Fast Flash (port 9) or Green Fast Flash (port 10): Alarm indication signal (AIS) from the trunk remote end.
- Red with Green Blink (port 9) or Green Blink (port 10): Port in loopback mode (set through IP Office System Monitor).
- LED 9 is also used for daughter card status. Flash every 5 seconds = Okay.

Name	Description	SAP Code
IPO 500 TRNK PRI 1 UNI	IP Office 500 Trunk Card Primary Rate 1 Universal	700417439
IPO 500 TRNK PRI 2 UNI	IP Office 500 Trunk Card Primary Rate 2 Universal	700417462

11.6 IP400 Expansion Modules

11.6.1 Analog Trunk 16

The IP400 Analog Trunk module (also known as the ATM16) is used to add 16 additional analog trunks to an IP Office system. The module supports both loop-start and, with suitable grounding, ground-start trunks.

- **IMPORTANT**

In all IP Office installations, any module being used for analog trunk connections must be connected to a [functional earth](#).

- **⚠ WARNING**

Within the Republic of South Africa and in areas of high lightning risk, any module using analog trunk connections must be connected to a [protective ground](#) and to [surge protection equipment](#).

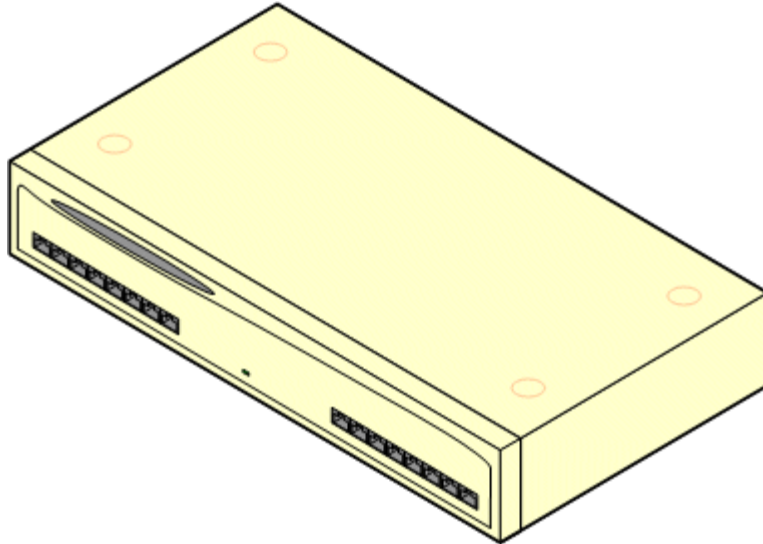

Feature	Details
Supported on	All IP Office control units except Small Office Edition. Use on the IP Office 500 control unit requires the unit to be configured with an IP500 Upgrade Standard to Professional license.
Locales	Specific variants are provided for different IP Office locales, see below.
Software Level	IP Office core software level 1.0 minimum. Bin file = naatm16.bin.
Included	Power supply unit (see below) and Expansion Interconnect cable.
Power Supply	The module is supplied with a 2-pin, 40W external power supply unit. The PSU has an integral power cord for connection to the module's DC I/P socket. A locale specific IEC60320 C7 power cord for the external PSU is required but is not supplied with the module.
Mounting	The module is designed as a free-standing module that can be stacked on or under other IP Office modules. The module can be rack mounted in a 19" rack system using the optional IP400 Rack Mounting Kit.
Dimensions	Width: 445mm/17.5". Depth: 245mm/9.7". Height: 71mm/2.8"/2U.
Weight	Unboxed: 2.9Kg/6.6lbs. Boxed: 4.2Kg/9.4lbs.

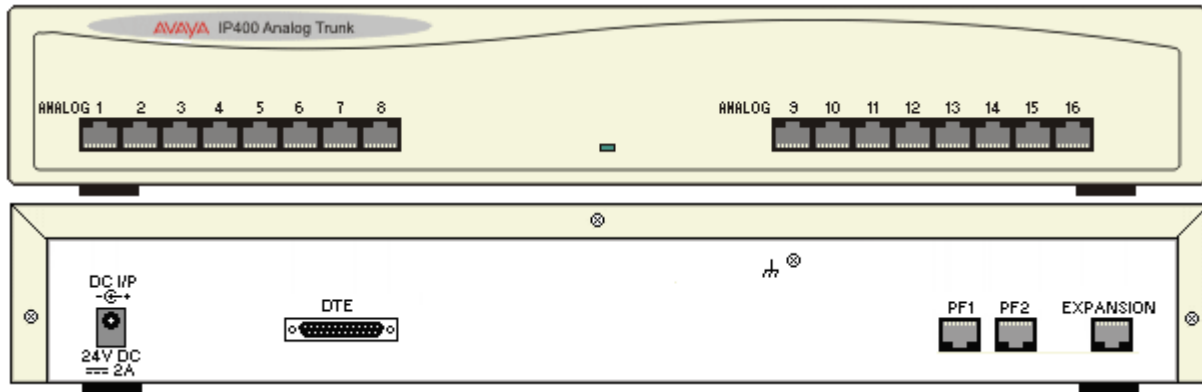

Ports	Description
ANALOG	RJ45 socket. Used for connection to analog trunks. Ports can be configured as either loop-start or ground-start trunks through the IP Office configuration. In the event of power failure, Analog ports 1 and 2 are directly connected to analog extension ports PF1 and PF2 respectively. If used the connected phones must be clearly labeled as power failure devices. This is only supported for loop-start analog trunks.
DC I/P	DC power input port. Used for connection of the power lead from an Avaya 40W external power supply unit supplied with the expansion module. A locale specific IEC60320 C7 power cord for the external PSU is required but is not supplied with the module.
DTE	25-Way D-Type socket. For Avaya use only.
EXPANSION	RJ45 Socket. Used for direct connection to an Expansion port on an IP Office control unit using the Expansion Interconnect cable supplied with the module.
PF	RJ45 socket. Power failure analog extension ports. See Analog section above.
	Ground point. Used for connection of a protective or functional ground if required. On older modules where this screw is not present, the top-center cover screw should be used instead. <ul style="list-style-type: none"> • IMPORTANT In all IP Office installations, any module being used for analog trunk connections must be connected to a functional earth. • ⚠ WARNING Within the Republic of South Africa and in areas of high lightning risk, any module using analog trunk connections must be connected to a protective ground and to surge protection equipment.

All expansion modules are supplied with a base software level and should be upgraded to match the core software of the control unit in the IP Office system.

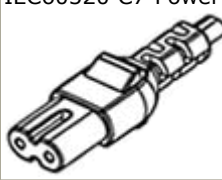
Item	Variant	Country	SAP Code
IP400 Analog Trunk 16	America	America	700211360
	Europe	Europe	700241680
	New Zealand	New Zealand	700241698
 IEC60320 C7 Power Cord	CEE7/16	Europe	700213382
	BS1363	United Kingdom	700213374
	NEMA1-15	America	700213390
	Korea	Korea	700254519
	China	China	700314172
IP400 Rack Mounting Kit		All	700210800

Expansion modules include an external power supply unit (PSU) and an appropriate interconnect cable. They do not include a locale specific power cord for the external PSU or any phone extension cables.

11.6.2 Digital Station V2

The IP400 Digital Station V2 (also known as DS V2) is used to add additional DS ports to an IP Office system. The DS V2 is available in 16 and 30 port variants, referred to as DS16 V2 and DS30 V2 respectively.

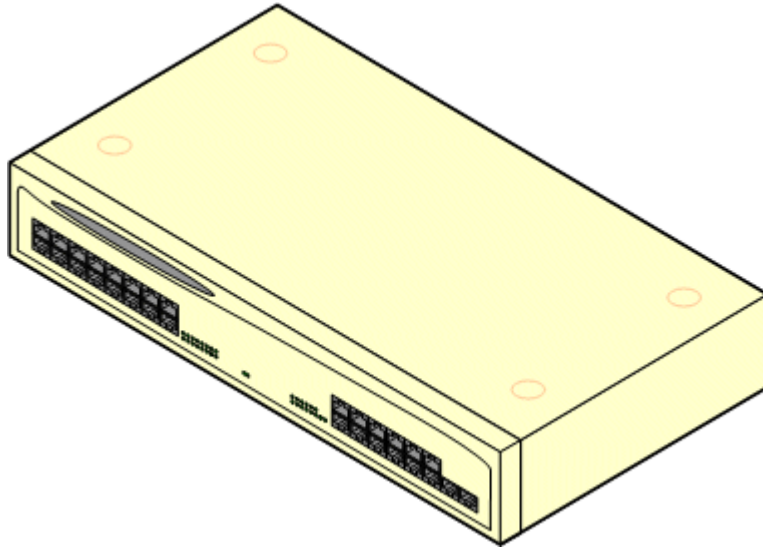

The DS V2 supersedes the original IP400 Digital Station, now referred to as a DS V1. The module version is indicated by labels both the base and the rear of the module. Key changes are:

- The DS ports have been rotated 180° to allow easier connection access.
- The port status LED's have been moved and grouped adjacent to the ports.
- The DTE serial port on the rear of the module has been changed to a 9-pin D-type socket.
- The DS V2 uses an earthed 3-pin 60W external power supply unit.

Feature	Details
Supported on	All IP Office control units except Small Office Edition. Use on the IP Office 500 control unit requires the unit to be configured with an IP500 Upgrade Standard to Professional license.
Locales	Supported in all IP Office locales.
Software Level	IP Office core software level 2.1(31) minimum. Bin file = nadcpV2.bin.
Included	Power supply unit (see below) and Expansion Interconnect cable.
Power Supply	The module is supplied with a Earthed 3-Pin, 60W external power supply module. The PSU has an integral power cord for connection to the module's DC I/P socket. A locale specific IEC60320 C13 power cord for the external PSU is required but is not supplied with the module.
Mounting	The module is designed as a free-standing module that can be stacked on or under other IP Office modules. The module can be rack mounted in a 19" rack system using the optional IP400 Rack Mounting Kit.
Dimensions	Width: 445mm/17.5". Depth: 245mm/9.7". Height: 71mm/2.8"/2U.
Weight	Unboxed: 3.5Kg/7.8lbs. Boxed: 4.8Kg/10.8lbs. (Based on DS30 V2)

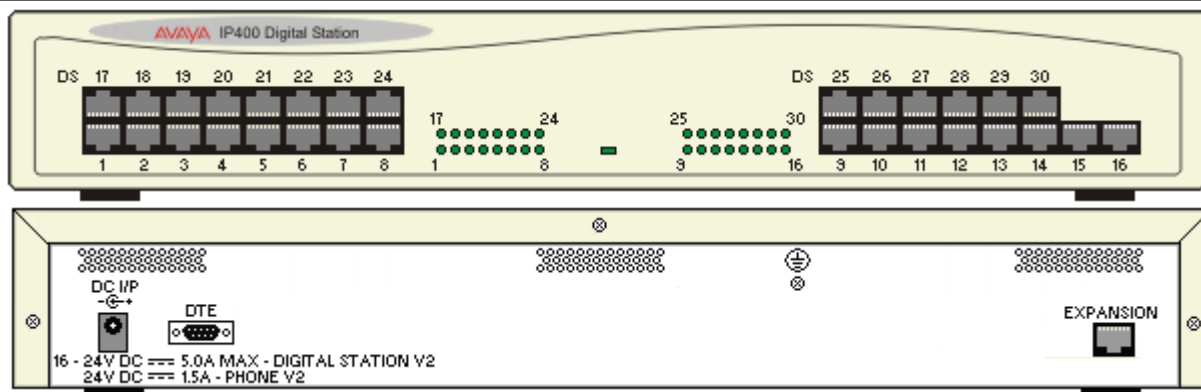

Ports	Description
DC I/P	DC power input port. Used for connection of the power lead from an Avaya earthed 60W external power supply unit supplied with the expansion module. A locale specific IEC60320 C13 power cord for the external PSU is required but is not supplied with the module.
DS	RJ45 socket. Digital Station port. Used for connection of IP Office supported DS phones . If connected to an out-of-building extension , the connection must be made via additional IROB barrier devices in addition to the buildings primary protection. The module must also be connected to a protective ground.
DTE	9-Way D-Type socket. For Avaya use only.
EXPANSION	RJ45 Socket. Used for direct connection to an Expansion port on an IP Office control unit using the Expansion Interconnect cable supplied with the module.
	Protective Ground point. Use of a protective ground is required for all installations, see Grounding (Earthing) . Where the module is connected to analog extensions in another building, an IP Office Phone Barrier Box V2 (101V) is required at both ends, see Lightning Protection/Out-of-Building Connections .

All expansion modules are supplied with a base software level and should be upgraded to match the core software of the control unit in the IP Office system.

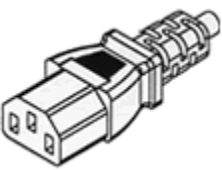
Item	Variant	Country	SAP Code
IP400 Digital Station V2	16 Ports	All	700359839
	30 Ports		700359847
 IEC60320 C13 Power Cord	CEE7/7	Europe	700289762
	BS1363	United Kingdom	700289747
	NEMA5-15P	America	700289770
	China	China	700261977
IP400 Rack Mounting Kit		All	700210800

Expansion modules include an external power supply unit (PSU) and an appropriate interconnect cable. They do not include a locale specific power cord for the external PSU or any phone extension cables.

11.6.3 Digital Station

The IP400 Digital Station module (also known as DS module) is used to add additional DS ports to an IP Office system.

The DS module is available in 16 and 30 port variants, referred to as DS16 and DS30 modules respectively. The IP400 Digital Station Module has been superseded by the [IP400 Digital Station Module V2](#).

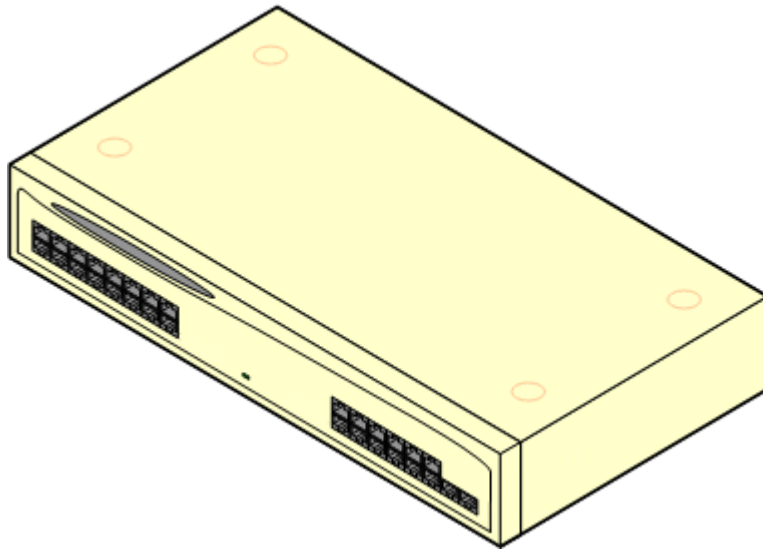

Feature	Details
Supported on	All IP Office control units except Small Office Edition. Use on the IP Office 500 control unit requires the unit to be configured with an IP500 Upgrade Standard to Professional license.
Locales	Supported in all IP Office locales.
Software Level	IP Office core software level 1.0 minimum. Bin file = nadcp-16.bin.
Included	Power supply unit (see below) and Expansion Interconnect cable.
Power Supply	The module is supplied with a 2-pin, 40W external power supply unit. The PSU has an integral power cord for connection to the module's DC I/P socket. A locale specific IEC60320 C7 power cord for the external PSU is required but is not supplied with the module.
Mounting	The module is designed as a free-standing module that can be stacked on or under other IP Office modules. The module can be rack mounted in a 19" rack system using the optional IP400 Rack Mounting Kit.
Dimensions	Width: 445mm/17.5". Depth: 245mm/9.7". Height: 71mm/2.8"/2U.
Weight	Unboxed: 3.5Kg/7.8lbs. Boxed: 4.8Kg/10.8lbs. (Based on DS30).

Digital Station Module Connections

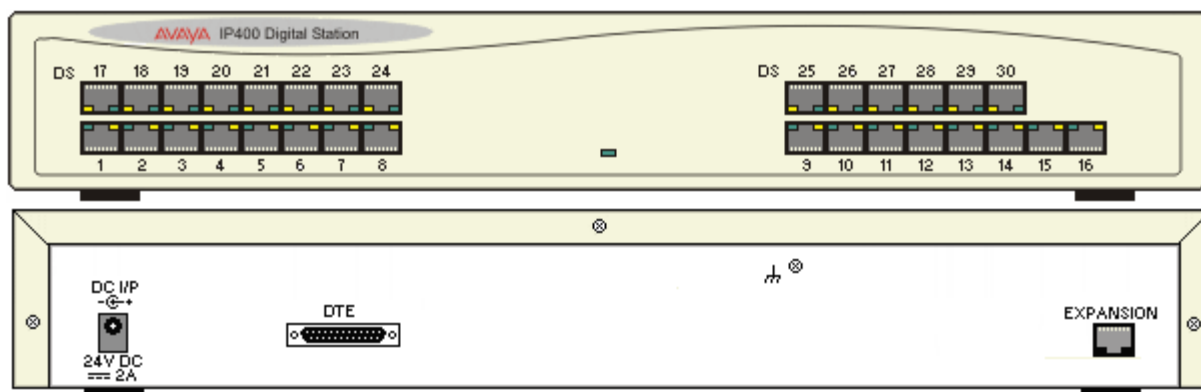

Ports	Description
DC I/P	DC power input port. Used for connection of the power lead from an Avaya 40W external power supply unit supplied with the expansion module. A locale specific IEC60320 C7 power cord for the external PSU is required but is not supplied with the module.
DS	Digital Station port. Used for connection of IP Office supported DS phones . If connected to an out-of-building extension , the connection must be made via additional IROB barrier devices in addition to the buildings primary protection. The module must also be connected to a protective ground.
DTE	25-Way D-Type socket. For Avaya use only.
EXPANSION	RJ45 Socket. Used for direct connection to an Expansion port on an IP Office control unit using the Expansion Interconnect cable supplied with the module.
	Ground point. Used for connection of a protective or functional ground if required. On older modules where this screw is not present, the top-center cover screw should be used instead. Must be connected if any out-of-building extensions are connected to this module.

All expansion modules are supplied with a base software level and should be upgraded to match the core software of the control unit in the IP Office system.

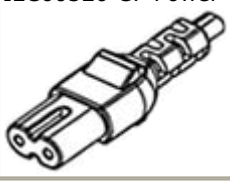
Item	Variant	Country	SAP Code
IP400 Digital Station	16 Ports	All	700184807
	30 Ports		700184880
 IEC60320 C7 Power Cord	CEE7/16	Europe	700213382
	BS1363	United Kingdom	700213374
	NEMA1-15	America	700213390
	Korea	Korea	700254519
	China	China	700314172
IP400 Rack Mounting Kit		All	700210800

Expansion modules include an external power supply unit (PSU) and an appropriate interconnect cable. They do not include a locale specific power cord for the external PSU or any phone extension cables.

11.6.4 Phone V2

The IP400 Phone V2 module (also known as the Phone V2 module) is used to add additional PHONE ports to an IP Office system. PHONE ports are used for analog phones.

The Phone V2 module is available in 8, 16 and 30 port variants, referred to as the Phone 8, Phone 16 and Phone 30 respectively.

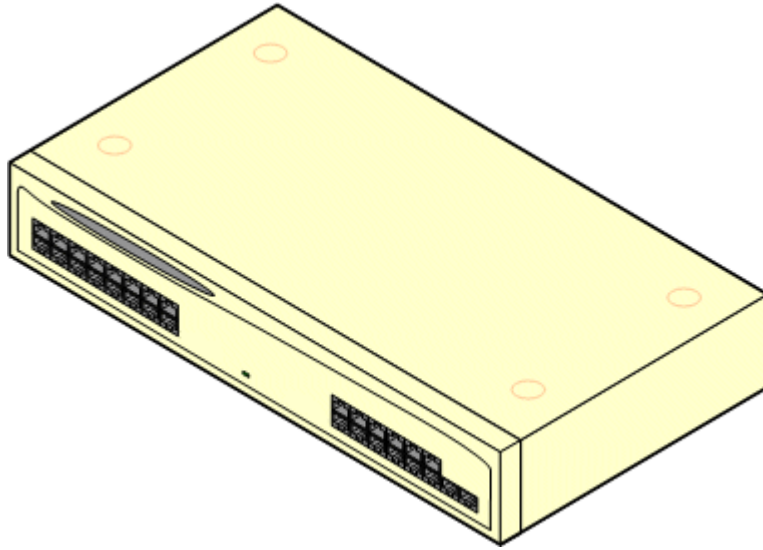

The Phone V2 module supersedes the original IP400 Phone module, now referred to as the Phone V1. The module version is indicated by labels on both the base and the rear of the module. Key changes are:

- The Phone V2 uses an earthed 3-pin 60W external power supply unit.
- With IP Office 3.1, the message waiting indication (MWI) on each port can be configured for None, On, 51V Stepped, 81V, Line Reversal A or Line Reversal B. On uses the default determined by the system locale. Ports on a Phone V2 module can additionally be configured for 101V operation.
- These ports do not include a ringing capacitor. Therefore for connection to 4-wire analog phones where this is a requirement (typically the United Kingdom and New Zealand), connection should be via a Master socket containing ringing capacitors.
- The DTE serial port on the rear of the module has been changed to a 9-pin D-type socket.

Feature	Details
Supported on	All IP Office control units except Small Office Edition. Use on the IP Office 500 control unit requires the unit to be configured with an IP500 Upgrade Standard to Professional license.
Locales	Supported in all IP Office locales.
Software Level	IP Office core software level 2.1(36) minimum. Bin file = dvpots.bin.
Included	Power supply unit (see below) and Expansion Interconnect cable.
Power Supply	The module is supplied with a Earthed 3-Pin, 60W external power supply unit. The PSU has an integral power cord for connection to the module's DC I/P socket. A locale specific IEC60320 C13 power cord for the external PSU is required but is not supplied with the module.
Mounting	The module is designed as a free-standing module that can be stacked on or under other IP Office modules. The module can be rack mounted in a 19" rack system using the optional IP400 Rack Mounting Kit.
Dimensions	Width: 445mm/17.5". Depth: 245mm/9.7". Height: 71mm/2.8"/2U.
Weight	Unboxed: 3.1Kg/6.94lbs. Boxed: 4.4Kg/9.7lbs. (Based on Phone 30 V2)

Phone Module V2 Connections

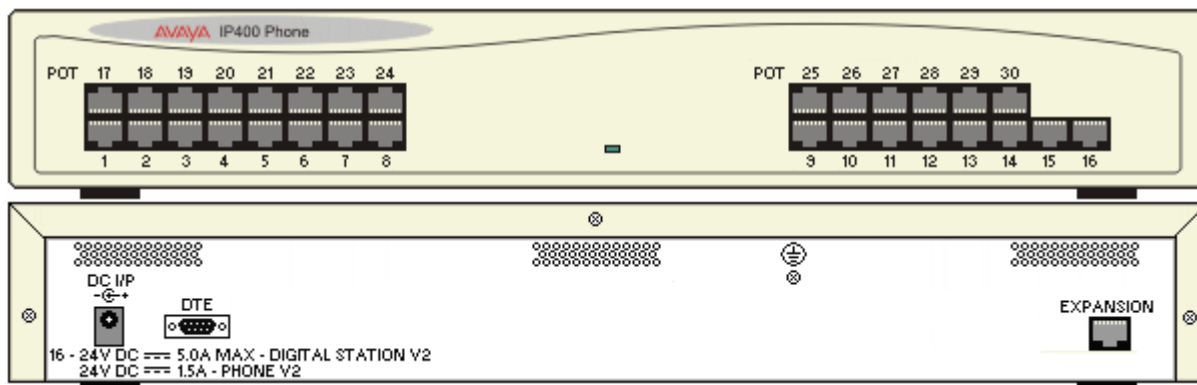

Ports	Description
DC I/P	DC power input port. Used for connection of the power lead from an Avaya earthed 60W external power supply unit supplied with the expansion module. A locale specific IEC60320 C13 power cord for the external PSU is required but is not supplied with the module.
DTE	9-Way D-Type socket. For Avaya use only.
EXPANSION	RJ45 Socket. Used for direct connection to an Expansion port on an IP Office control unit using the Expansion Interconnect cable supplied with the module.
PHONE	RJ45 socket. Used for connection of analog phones. Intended for two-wire analog phones. For connection to 4-wire analog phones connection should be via a master socket with ringing capacitors. If connected to an out-of-building extension , the connection must be made via additional IP Office Barrier Boxes in addition to the buildings primary protection. The module must also be connected to a protective ground.
	Protective Ground point. Use of a protective ground is required for all installations, see Grounding (Earthing) . Where the module is connected to analog extensions in another building, an IP Office Phone Barrier Box V2 (101V) is required at both ends, see Lightning Protection/Out-of-Building Connections .

All expansion modules are supplied with a base software level and should be upgraded to match the core software of the control unit in the IP Office system.

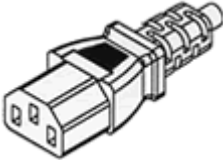
Item	Variant	Country	SAP Code
IP400 Phone V2	8 Ports	All	700359896
	16 Ports		700359904
	30 Ports		700359912
 IEC60320 C13 Power Cord	CEE7/7	Europe	700289762
	BS1363	United Kingdom	700289747
	NEMA5-15P	America	700289770
	China	China	700261977
IP400 Rack Mounting Kit		All	700210800

Expansion modules include an external power supply unit (PSU) and an appropriate interconnect cable. They do not include a locale specific power cord for the external PSU or any phone extension cables.

11.6.5 Phone

The IP400 Phone module (also known as the Phone V1 module) is used to add additional POT ports to an IP Office system. POT ports are used for analog phones.

The Phone module is available in 8, 16 and 30 port variants, referred to as the Phone 8, Phone 16 and Phone 30 respectively. The IP400 Phone Module has been superseded by the [Phone Module V2](#).

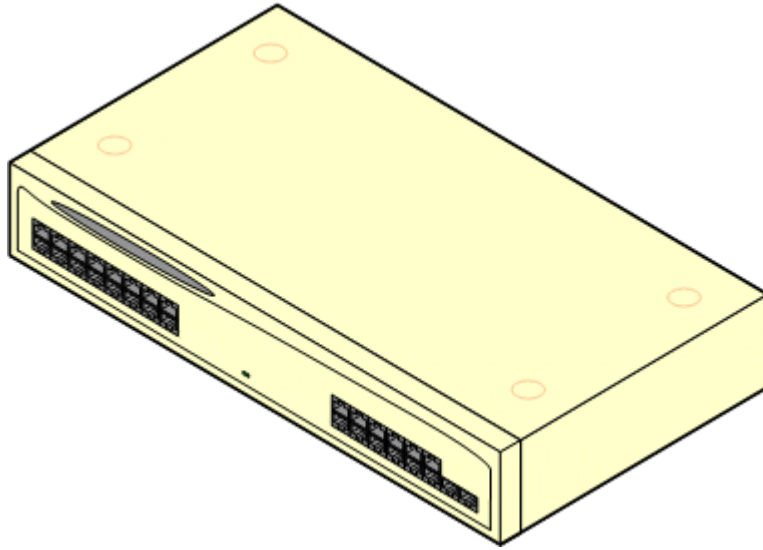

- With IP Office 3.1 and higher, the message waiting indication (MWI) on each POT port can be configured for None, On, 51V Stepped, 81V, Line Reversal A or Line Reversal B. On uses the default determined by the system locale. POT ports on a Phone V2 module can additionally be configured for 101V operation.

Feature	Details
Supported on	All IP Office control units except Small Office Edition. Use on the IP Office 500 control unit requires the unit to be configured with an IP500 Upgrade Standard to Professional license.
Locales	Supported in all IP Office locales.
Software Level	IP Office core software level 1.0 minimum. Bin file = napots16.bin (earlier units, not supported on IP500) or avpots16.bin (later units).
Included	Power supply unit (see below) and Expansion Interconnect cable.
Power Supply	The module is supplied with a 2-pin, 40W external power supply unit. The PSU has an integral power cord for connection to the module's DC I/P socket. A locale specific IEC60320 C7 power cord for the external PSU is required but is not supplied with the module.
Mounting	The module is designed as a free-standing module that can be stacked on or under other IP Office modules. The module can be rack mounted in a 19" rack system using the optional IP400 Rack Mounting Kit.
Dimensions	Width: 445mm/17.5". Depth: 245mm/9.7". Height: 71mm/2.8"/2U.
Weight	Unboxed: 3.1Kg/6.94lbs. Boxed: 4.4Kg/9.7lbs. (Based on Phone 30 V2).

Phone V1 Module Connections

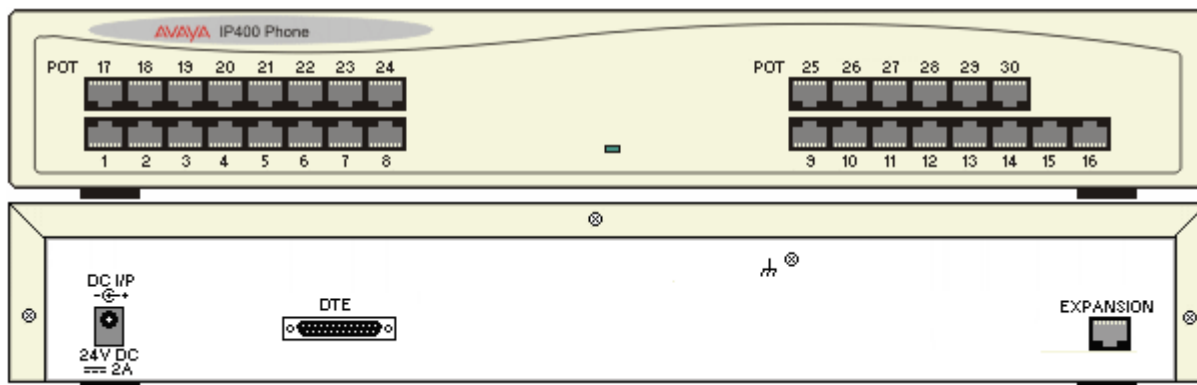

Ports	Description
DC I/P	DC power input port. Used for connection of the power lead from an Avaya 40W external power supply unit supplied with the expansion module. A locale specific IEC60320 C7 power cord for the external PSU is required but is not supplied with the module.
DTE	25-Way D-Type socket. For Avaya use only.
EXPANSION	RJ45 Socket. Used for direct connection to an Expansion port on an IP Office control unit using the Expansion Interconnect cable supplied with the module.
POT	RJ45 socket. Used for connection of analog phones. If connected to an out-of-building extension , the connection must be made via additional IP Office Barrier Box devices in addition to the buildings primary protection. The module must also be connected to a protective ground.
	Function ground point. Used for connection of a protective or functional ground if required. On older modules where this screw is not present, the top-center cover screw should be used instead. Must be connected if any out-of-building extensions are connected to this module.

All expansion modules are supplied with a base software level and should be upgraded to match the core software of the control unit in the IP Office system.

Item	Variant	Country	SAP Code
IP400 Phone V1	8 Ports	All	700184773
	16 Ports		700184781
	30 Ports		700184799
 IEC60320 C7 Power Cord	CEE7/16	Europe	700213382
	BS1363	United Kingdom	700213374
	NEMA1-15	America	700213390
	Korea	Korea	700254519
	China	China	700314172
IP400 Rack Mounting Kit		All	700210800

Expansion modules include an external power supply unit (PSU) and an appropriate interconnect cable. They do not include a locale specific power cord for the external PSU or any phone extension cables.

11.6.6 So8

The So8 module is used to add ETSI BRI S0-interface ports to the IP Office system. These ports can then be used for the connection of ISDN devices.

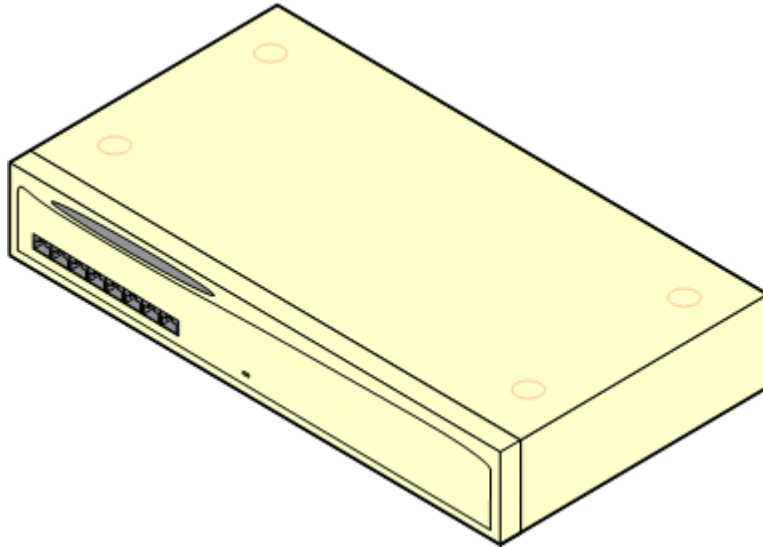

Feature	Details
Supported on	All IP Office control units except Small Office Edition. Use on the IP Office 500 control unit requires the unit to be configured with an IP500 Upgrade Standard to Professional license.
Locales	Supported in all IP Office locales.
Software Level	IP Office core software level 1.0 minimum. Bin file = nas0-16.bin.
Included	Power supply unit (see below) and Expansion Interconnect cable.
Power Supply	The unit is supplied with an earthed 3-Pin, 60W external power supply unit. The PSU has an integral power cord for connection to the unit's DC I/P socket. A locale specific IEC60320 C13 power cord for the external PSU is required but is not supplied with the unit. <ul style="list-style-type: none"> Older units were supplied with a 2-Pin, 40W external power supply unit which used a locale specific locale specific IEC60320 C7 power cord.
Mounting	The module is designed as a free-standing module that can be stacked on or under other IP Office modules. The module can be rack mounted in a 19" rack system using the optional IP400 Rack Mounting Kit.
Dimensions	Width: 445mm/17.5". Depth: 245mm/9.7". Height: 71mm/2.8"/2U.
Weight	Unboxed: 2.8Kg/6.3lbs. Boxed: 4.1Kg/9.2lbs.

So8 Module Connections

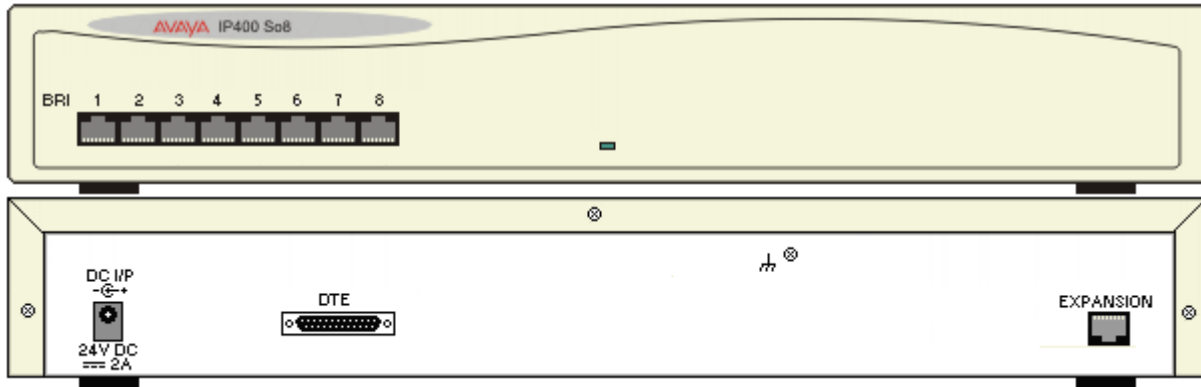

Ports	Description
BRI	RJ45 socket. Used for connection of ISDN terminal devices. Note: These ports appear a lines within the IP Office configuration. However they cannot be used for connection to external BRI lines.
DC I/P	DC power input port. Used for connection of the power lead from an Avaya 60W external power supply unit supplied with the expansion module. A locale specific IEC60320 C13 power cord for the external PSU is required but is not supplied with the module.
DTE	25-Way D-Type socket. For Avaya use only.
EXPANSION	RJ45 Socket. Used for direct connection to an Expansion port on an IP Office control unit using the Expansion Interconnect cable supplied with the module.
	Function ground point. Used for connection of a protective or functional ground if required. On older modules where this screw is not present, the top-center cover screw should be used instead.

All expansion modules are supplied with a base software level and should be upgraded to match the core software of the control unit in the IP Office system. Expansion modules include an external power supply unit (PSU) and an appropriate interconnect cable. They do not include a locale specific power cord for the external PSU or any phone extension cables.

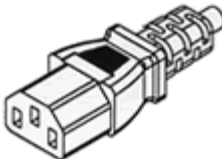
Item	Variant	Country	SAP Code
IP400 So8		All	700185077
	CEE7/7	Europe	700289762
	BS1363	United Kingdom	700289747
	NEMA5-15P	America	700289770
	China	China	700261977
IP400 Rack Mounting Kit		All	700210800

11.6.7 WAN3 10/100

The IP400 WAN3 10/100 module can be used to add an additional 3 WAN ports to an IP Office system. These ports are used for V.24, V.35 and X.21 WAN services.

Unlike other external expansion modules the WAN3 10/100 module connects to the IP Office control unit via LAN ports. It has its own IP address, which is obtained by DHCP.

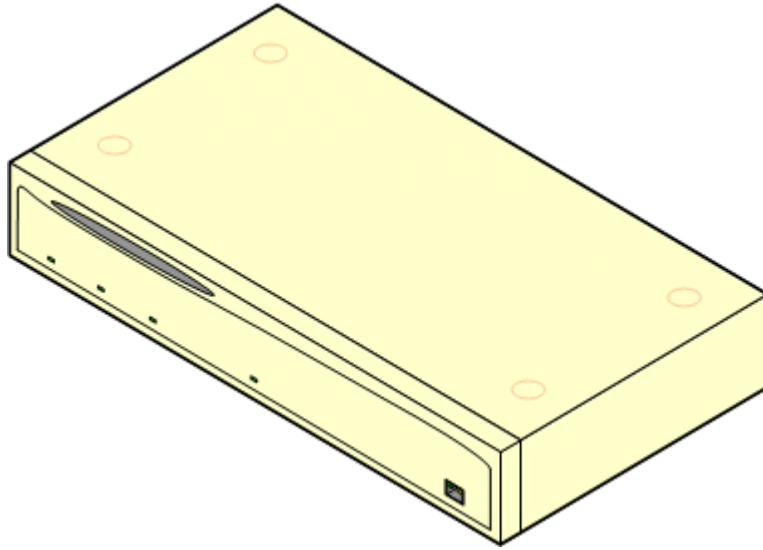

The WAN3 exists in two variants. The original WAN3 only supported a 10Mbps LAN connection and is not supported on IP Office 3.2 and higher. The WAN3 has been superseded by the WAN3 10/100 which supports a 10Mbps/100Mbps LAN connection.

Feature	Details
Supported on	All IP400 control units except Small Office Edition and IP500.
Locales	Supported in all IP Office locales.
Software Level	WAN3 10/100: IP Office core software level 1.4 minimum. Bin file = ipwan3.bin.
Included	Power supply unit (see below) and LAN Interconnect cable.
Power Supply	The unit is supplied with an earthed 3-Pin, 60W external power supply unit. The PSU has an integral power cord for connection to the unit's DC I/P socket. A locale specific IEC60320 C13 power cord for the external PSU is required but is not supplied with the unit. <ul style="list-style-type: none"> Older units were supplied with a 2-Pin, 40W external power supply unit which used a locale specific locale specific IEC60320 C7 power cord.
Mounting	The module is designed as a free-standing module that can be stacked on or under other IP Office modules. The module can be rack mounted in a 19" rack system using the optional IP400 Rack Mounting Kit.
Dimensions	Width: 445mm/17.5". Depth: 245mm/9.7". Height: 71mm/2.8"/2U.
Weight	Unboxed: 2.8Kg/6.3lbs. Boxed: 4.1Kg/9.2lbs.

WAN3 Module Connections

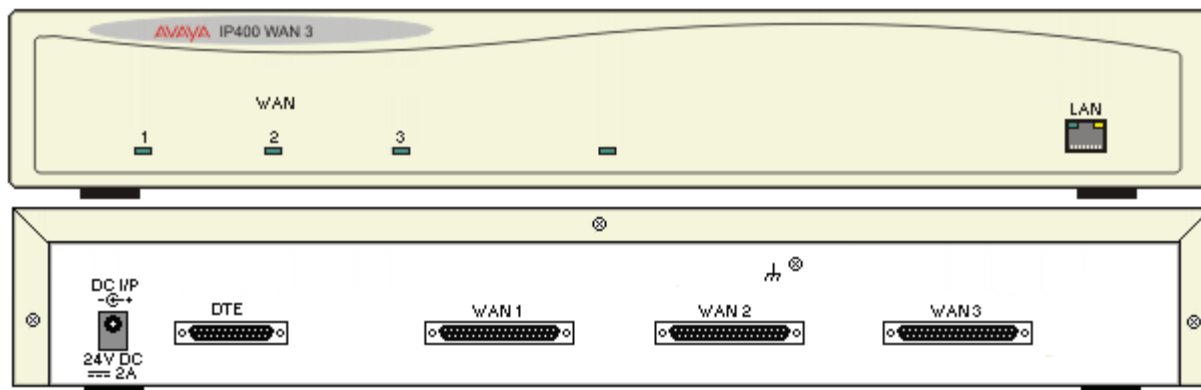

Ports	Description
DC I/P	DC power input port. Used for connection of the power lead from an Avaya 40W external power supply unit supplied with the expansion module. A locale specific IEC60320 C7 power cord for the external PSU is required but is not supplied with the module.
DTE	25-Way D-Type socket. For Avaya use only.
EXPANSION	RJ45 Socket. Used for direct connection to an Expansion port on an IP Office control unit using the Expansion Interconnect cable supplied with the module.
LAN	RJ45 socket. Used for direct connection to a LAN port on the IP Office control unit. A LAN Interconnect cable is supplied with the module for that purpose. When connecting to an IP412 control unit a LAN crossover cable should be used.
WAN	<p>These ports support a single synchronous data connection, which can be X.21, V.35 or V.24/V.28. The selection of the required interface is automatically determined from the pin-out of the cable plugged into the WAN port. This cable must be connected before power is applied for auto detection to work. Connection to a Digital Leased Circuit is made by connecting the WAN port on the rear of the module to the existing Network Terminating Module (NTU) via the appropriate X.21, V.35 or V.24 cable. These WAN ports are identical to those on the IP406 V2 and IP412 control units.</p> <ul style="list-style-type: none"> These WAN ports must be clocked externally, the IP Office does not provide a clock signal. The clock signal is usually provided by the service provider but under some circumstances (for example laser, microwave or baseband modems) extra provision must be made by the installer.
	Function ground point. Used for connection of a protective or functional ground if required. On older modules where this screw is not present, the top-center cover screw should be used instead.

All expansion modules are supplied with a base software level and should be upgraded to match the core software of the control unit in the IP Office system. Expansion modules include an external power supply unit (PSU) and an appropriate interconnect cable. They do not include a locale specific power cord for the external PSU or any phone extension cables.

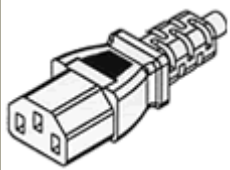
Item	Variant	Country	SAP Code
IP400 WAN3		All	700185028
IP400 WAN3 10/100			700262009
	CEE7/16	Europe	700289762
	BS1363	United Kingdom	700289747
	NEMA5-15P	America	700289770
	China	China	700261977
IP400 Rack Mounting Kit		All	700210800

11.7 IP500 Expansion Modules

11.7.1 Analog Trunk 16

The IP500 Analog Trunk module can be used to add 16 additional analog trunks to an IP Office system. The module supports both loop-start and, with suitable grounding, ground-start trunks. This module is currently only supported in the US locale.

- **IMPORTANT**

In all IP Office installations, any module being used for analog trunk connections must be connected to a [functional earth](#).

- **⚠ WARNING**

Within areas of high lightning risk, any module using analog trunk connections must be connected to a [protective ground](#) and to [surge protection equipment](#) (an Avaya 146G Surge Protector).

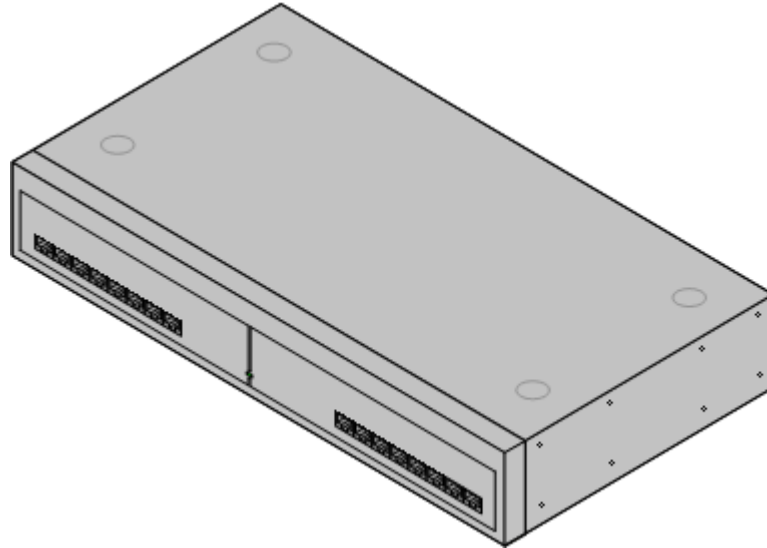

Feature	Details
Supported on	All IP Office control units except Small Office Edition. Use on the IP Office 500 control unit requires the unit to be configured with an IP500 Upgrade Standard to Professional license.
Locales	Specific variants are provided for different IP Office locales, see below.
Software Level	IP Office core software level 1.0 minimum. Bin file = naatm16.bin.
Included	Power supply unit (see below) and Expansion Interconnect cable.
Power Supply	The module is supplied with a 2-pin, 40W external power supply unit. The PSU has an integral power cord for connection to the module's DC I/P socket. A locale specific IEC60320 C7 power cord for the external PSU is required but is not supplied with the module.
Mounting	The module is designed as a free-standing module that can be stacked on or under other IP Office modules. The module can be rack mounted in a 19" rack system using the optional IP500 Rack Mounting Kit.
Dimensions	Width: 445mm/17.5". Depth: 245mm/9.7". Height: 71mm/2.8"/2U.
Weight	Unboxed: 2.9Kg/6.6lbs. Boxed: 4.2Kg/9.4lbs.

IPO 500 Analog Trunk Module Connections

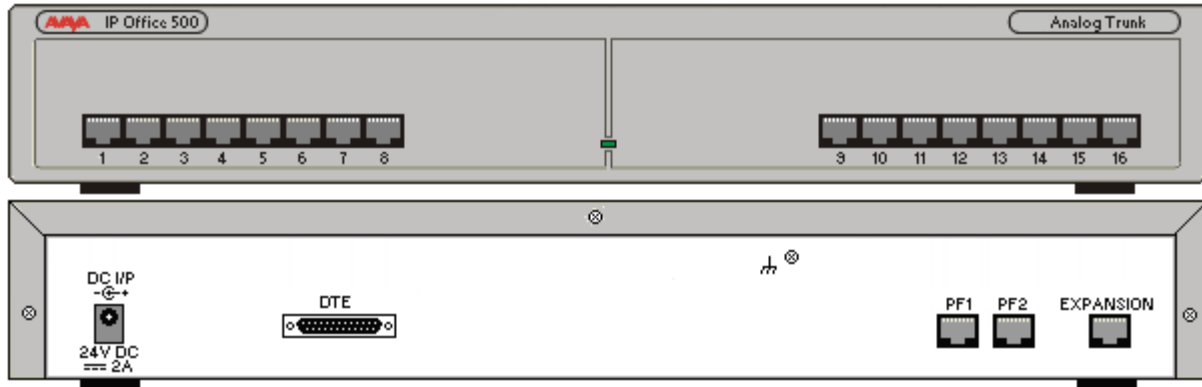

Ports	Description
ANALOG	RJ45 socket. Used for connection to analog trunks. Ports can be configured as either loop-start or ground-start trunks through the IP Office configuration. In the event of power failure, Analog ports 1 and 2 are directly connected to analog extension ports PF1 and PF2 respectively. If used the connected phones must be clearly labeled as power failure devices. This is only supported for loop-start analog trunks.
DC I/P	DC power input port. Used for connection of the power lead from an Avaya 40W external power supply unit supplied with the expansion module. A locale specific IEC60320 C7 power cord for the external PSU is required but is not supplied with the module.
DTE	25-Way D-Type socket. For Avaya use only.
EXPANSION	RJ45 Socket. Used for direct connection to an Expansion port on an IP Office control unit using the Expansion Interconnect cable supplied with the module.
PF	RJ45 socket. Power failure analog extension ports. See Analog section above.
	Ground point. Used for connection of a protective or functional ground if required. On older modules where this screw is not present, the top-center cover screw should be used instead. <ul style="list-style-type: none"> • IMPORTANT In all IP Office installations, any module being used for analog trunk connections must be connected to a functional earth. • ⚠ WARNING Within areas of high lightning risk, any module using analog trunk connections must be connected to a protective ground and to surge protection equipment.

All expansion modules are supplied with a base software level and should be upgraded to match the core software of the control unit in the IP Office system.

Item	Variant	Country	SAP Code
IPO 500 Analog Trunk 16	America	America	700449473
IEC60320 C7 Power Cord	NEMA1-15	America	700213390
IP500 Rack Mounting Kit		All	700429202

Expansion modules include an external power supply unit (PSU) and an appropriate interconnect cable. They do not include a locale specific power cord for the external PSU or any phone extension cables.

11.7.2 BRI S08

The So8 module can be used to add ETSI BRI S0-interface ports to the IP Office system. These ports can then be used for the connection of ISDN devices.

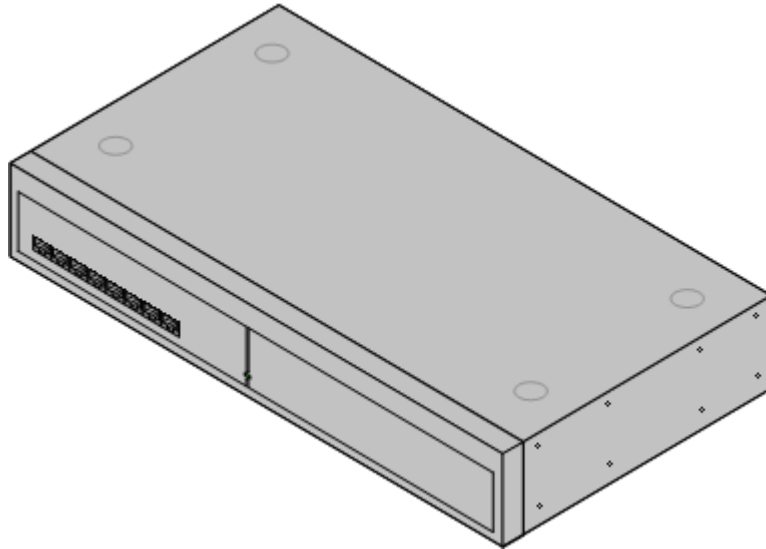

Feature	Details
Supported on	All IP Office control units except Small Office Edition. Use on the IP Office 500 control unit requires the unit to be configured with an IP500 Upgrade Standard to Professional license.
Locales	Supported in all IP Office locales.
Software Level	IP Office core software level 1.0 minimum. Bin file = nas0-16.bin.
Included	Power supply unit (see below) and Expansion Interconnect cable.
Power Supply	The unit is supplied with an earthed 3-Pin, 60W external power supply unit. The PSU has an integral power cord for connection to the unit's DC I/P socket. A locale specific IEC60320 C13 power cord for the external PSU is required but is not supplied with the unit.
Mounting	The module is designed as a free-standing module that can be stacked on or under other IP Office modules. The module can be rack mounted in a 19" rack system using the optional IP500 Rack Mounting Kit.
Dimensions	Width: 445mm/17.5". Depth: 245mm/9.7". Height: 71mm/2.8"/2U.
Weight	Unboxed: 2.8Kg/6.3lbs. Boxed: 4.1Kg/9.2lbs.

IPO 500 So8 Module Connections

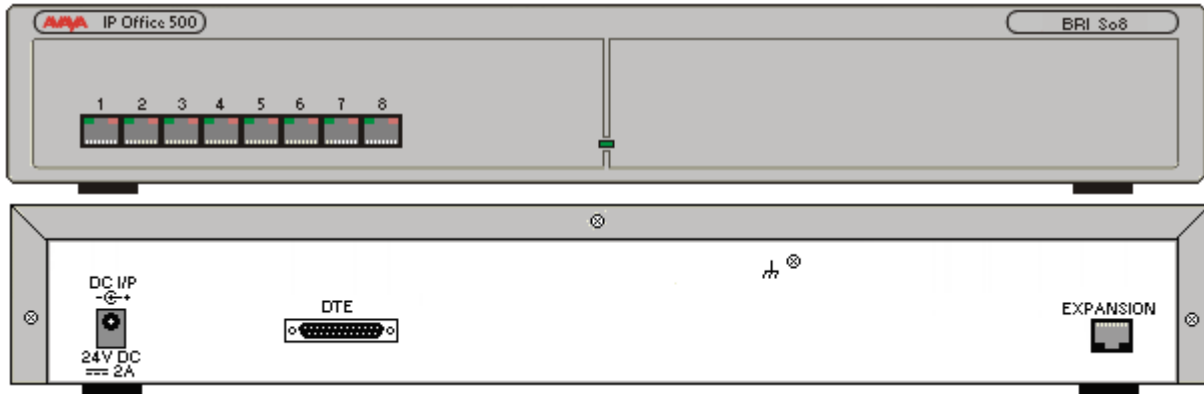

Ports	Description
BRI	RJ45 socket. Used for connection of ISDN terminal devices. Note: These ports appear a lines within the IP Office configuration. However they cannot be used for connection to external BRI lines.
DC I/P	DC power input port. Used for connection of the power lead from an Avaya 60W external power supply unit supplied with the expansion module. A locale specific IEC60320 C13 power cord for the external PSU is required but is not supplied with the module.
DTE	25-Way D-Type socket. For Avaya use only.
EXPANSION	RJ45 Socket. Used for direct connection to an Expansion port on an IP Office control unit using the Expansion Interconnect cable supplied with the module.
	Function ground point. Used for connection of a protective or functional ground if required. On older modules where this screw is not present, the top-center cover screw should be used instead.

All expansion modules are supplied with a base software level and should be upgraded to match the core software of the control unit in the IP Office system. Expansion modules include an external power supply unit (PSU) and an appropriate interconnect cable. They do not include a locale specific power cord for the external PSU or any phone extension cables.

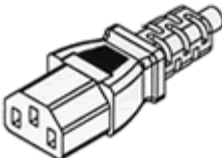
Item	Variant	Country	SAP Code
IPO 500 BRI So8		All	700449515
	CEE7/7	Europe	700289762
	BS1363	United Kingdom	700289747
	NEMA5-15P	America	700289770
	China	China	700261977
IP500 Rack Mounting Kit		All	700429202

11.7.3 Digital Station

IPO 500 Digital Station modules can be used to add additional DS ports to an IP Office system. Note that this requires the IP Office 500 control unit to be configured with an IP500 Upgrade Standard to Professional license.

The module is available in 16 and 30 port variants, referred to as the IPO 500 Digital Station 16 and IPO 500 Digital Station 30 respectively.

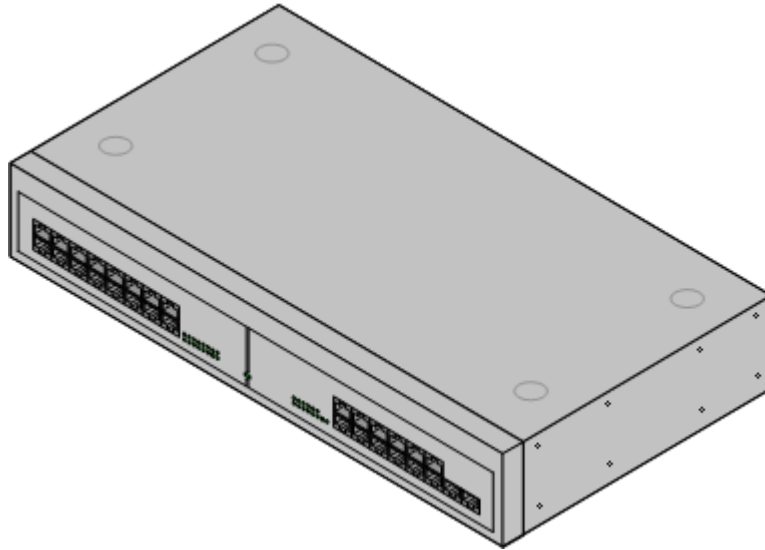

Feature	Details
Supported on	All IP Office control units except Small Office Edition. Use on the IP Office 500 control unit requires the unit to be configured with an IP500 Upgrade Standard to Professional license.
Locales	Supported in all IP Office locales.
Software Level	IP Office core software level 2.1(31) minimum. Bin file = nadcpV2.bin.
Included	Power supply unit (see below) and Expansion Interconnect cable.
Power Supply	The module is supplied with a Earthed 3-Pin, 60W external power supply module. The PSU has an integral power cord for connection to the module's DC I/P socket. A locale specific IEC60320 C13 power cord for the external PSU is required but is not supplied with the module.
Mounting	The module is designed as a free-standing module that can be stacked on or under other IP Office modules. The module can be rack mounted in a 19" rack system using the optional IP500 Rack Mounting Kit.
Dimensions	Width: 445mm/17.5". Depth: 245mm/9.7". Height: 71mm/2.8".
Weight	Unboxed: 3.5Kg/7.8lbs. Boxed: 4.8Kg/10.8lbs. (Based on DS30 V2)

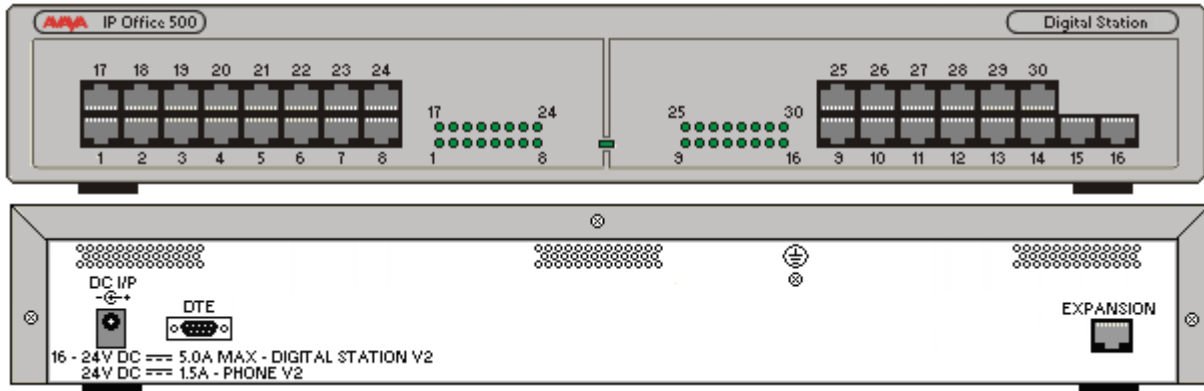

Ports	Description
DC I/P	DC power input port. Used for connection of the power lead from an Avaya earthed 60W external power supply unit supplied with the expansion module. A locale specific IEC60320 C13 power cord for the external PSU is required but is not supplied with the module.
DS	RJ45 socket. Digital Station port. Used for connection of IP Office supported DS phones . If connected to an out-of-building extension , the connection must be made via additional IROB barrier devices in addition to the buildings primary protection. The module must also be connected to a protective ground.
DTE	9-Way D-Type socket. For Avaya use only.
EXPANSION	RJ45 Socket. Used for direct connection to an Expansion port on an IP Office control unit using the Expansion Interconnect cable supplied with the module.
	Protective Ground point. Use of a protective ground is required for all installations, see Grounding (Earthing) . Where the module is connected to analog extensions in another building, an IP Office Phone Barrier Box V2 (101V) is required at both ends, see Lightning Protection/Out-of-Building Connections .

All expansion modules are supplied with a base software level and should be upgraded to match the core software of the control unit in the IP Office system.

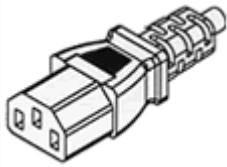
Item	Variant	Country	SAP Code
IPO 500 Digital Station	16 Ports	All	700449499
	30 Ports		700426216
 IEC60320 C13 Power Cord	CEE7/7	Europe	700289762
	BS1363	United Kingdom	700289747
	NEMA5-15P	America	700289770
	China	China	700261977
IP500 Rack Mounting Kit		All	700429202

Expansion modules include an external power supply unit (PSU) and an appropriate interconnect cable. They do not include a locale specific power cord for the external PSU or any phone extension cables.

11.7.4 Phone

IPO 500 Phone modules can be used to add additional PHONE ports to an IP Office system. Note that this requires the IP Office 500 control unit to be configured with an IP500 Upgrade Standard to Professional license.

The module is available in 16 and 30 port variants, referred to as the IPO 500 Phone 16 and IPO 500 Phone 30 respectively.

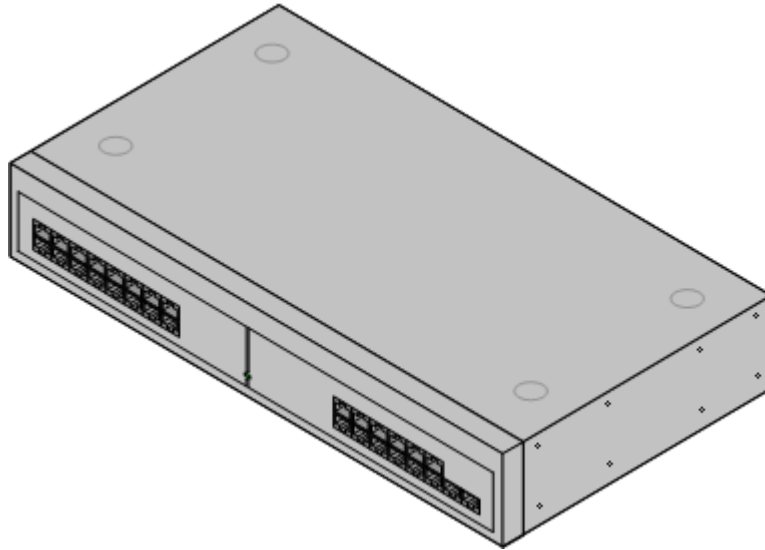

Feature	Details
Supported on	All IP Office control units except Small Office Edition. Use on the IP Office 500 control unit requires the unit to be configured with an IP500 Upgrade Standard to Professional license.
Locales	Supported in all IP Office locales.
Software Level	IP Office core software level 2.1(36) minimum. Bin file = dvpots.bin.
Included	Power supply unit (see below) and Expansion Interconnect cable.
Power Supply	The module is supplied with a Earthed 3-Pin, 60W external power supply unit. The PSU has an integral power cord for connection to the module's DC I/P socket. A locale specific IEC60320 C13 power cord for the external PSU is required but is not supplied with the module.
Mounting	The module is designed as a free-standing module that can be stacked on or under other IP Office modules. The module can be rack mounted in a 19" rack system using the optional IP500 Rack Mounting Kit.
Dimensions	Width: 445mm/17.5". Depth: 245mm/9.7". Height: 71mm/2.8".
Weight	Unboxed: 3.1Kg/6.94lbs. Boxed: 4.4Kg/9.7lbs. (Based on Phone 30 V2)

IPO 500 Phone Connections

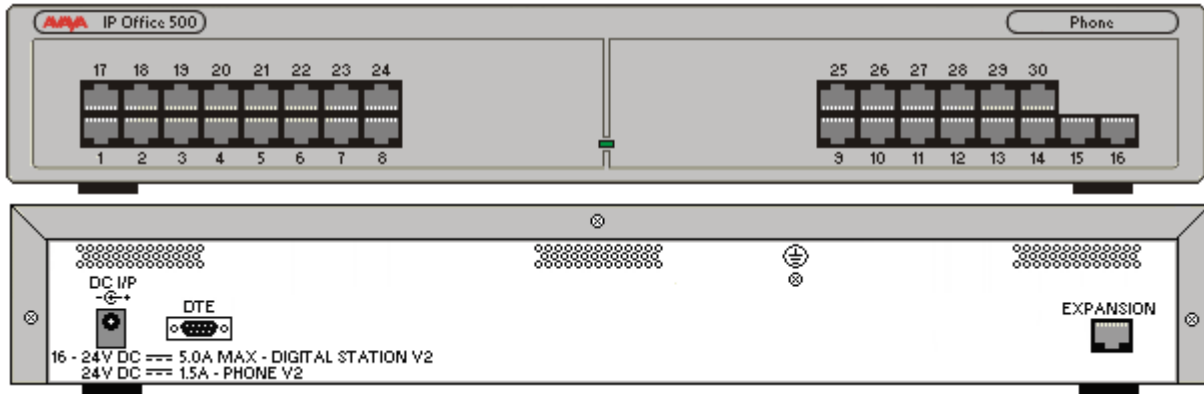

Ports	Description
DC I/P	DC power input port. Used for connection of the power lead from an Avaya earthed 60W external power supply unit supplied with the expansion module. A locale specific IEC60320 C13 power cord for the external PSU is required but is not supplied with the module.
DTE	9-Way D-Type socket. For Avaya use only.
EXPANSION	RJ45 Socket. Used for direct connection to an Expansion port on an IP Office control unit using the Expansion Interconnect cable supplied with the module.
PHONE	RJ45 socket. Used for connection of analog phones. Intended for two-wire analog phones. For connection to 4-wire analog phones connection should be via a master socket with ringing capacitors. If connected to an out-of-building extension , the connection must be made via additional IP Office Barrier Boxes in addition to the buildings primary protection. The module must also be connected to a protective ground.
	Protective Ground point. Use of a protective ground is required for all installations, see Grounding (Earthing) . Where the module is connected to analog extensions in another building, an IP Office Phone Barrier Box V2 (101V) is required at both ends, see Lightning Protection/Out-of-Building Connections .

All expansion modules are supplied with a base software level and should be upgraded to match the core software of the control unit in the IP Office system.

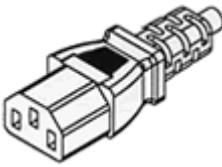
Item	Variant	Country	SAP Code
IPO 500 Phone	16 Ports	All	700449507
	30 Ports	All	700426224
 IEC60320 C13 Power Cord	CEE7/7	Europe	700289762
	BS1363	United Kingdom	700289747
	NEMA5-15P	America	700289770
	China	China	700261977
IP500 Rack Mounting Kit		All	700429202

Expansion modules include an external power supply unit (PSU) and an appropriate interconnect cable. They do not include a locale specific power cord for the external PSU or any phone extension cables.

11.8 Phones

IP Office 4.2 supports the following phones and phone add-ons. Availability may be subject to local restrictions.

Digital stations connect to the IP Office via [DS](#) ports.

Series	IP Office Supported Digital Station (DS) Phones	Region
2400	2402 , 2410 , 2420 .	Global
4400	4406D , 4412D+ , 4424D+ . Not supported on the IP500 Digital Station card.	North America
5400	5402 , 5410 , 5420 .	Global
6400	6408D , 6416D+M , 6424D+M .	Global
T3 (Upn)	T3 Compact , T3 Classic , T3 Comfort .	Europe, Middle East and Africa
-	3810 Wireless phone .	North America

H323 IP Phones connect to the IP Office system via the RJ45 LAN or WAN.

Series	IP Office Supported H323 IP Phones	Region
1600	1603 , 1608 , 1616	Global
3600	3616 , 3620 , 3626 , 3641 , 3645 (Connect via AVPP add-on module).	
4600	4601 , 4602 , 4602SW , 4610 , 4610SW , 4620 , 4620SW , 4621SW , 4625 .	
5600	5601 , 5602 , 5602SW , 5610 , 5620 , 5621 .	
Softphone	Phone Manager Pro PC Softphone application (requires Phone Manager Pro and Phone Manager IP Audio licenses).	
T3 (IP)	T3 IP Compact , T3 IP Classic , T3 IP Comfort .	Europe, Middle East and Africa
Others	Other IP softphones and hardphones require entry of an IP Endpoints license. Functionality beyond making and answering calls is not guaranteed by Avaya.	-

Analog phones and devices connect to [PHONE](#) ports with the IP Office system. However due to the variety of analog phones and device available no guarantee of operation is given. It is the responsibility of the IP Office installer and maintainer to test and verify the operation of proposed analog equipment.

Series	IP Office Recommended Analog Phones	Region
6200 Series	6211, 6219, 6221.	North America
Interquartz Gemini	9330-AV, 9335-AV, 9281-AV.	Europe, Middle East, Africa, Asia-Pacific

Series	IP Office Supported DECT Phones	Region
IP DECT	3701 , 3711 - Connection via IP DECT base stations.	Global

11.8.1 1603

This phone is supported with IP Office 4.2 and higher.

1603	Feature	1603
	Connects via	IP network.
	IP Office Release	4.2 Q4 2008+
	Programmable Buttons	✓ 3
	Headset Socket	✗
	Handsfree Speaker/ Microphone	✓/✓
	Message Waiting Lamp	✓
	PoE Class/Typical Idle Power Consumption	Class 2 (4.3W)
	Display	2 x 16 backlit.
	Supported Add-Ons	None
	Upgradeable Firmware	✓
PC Pass-Through Port/ with Voice Priority	✗/✗	

Fixed Telephony Function Keys

✓ SPEAKER	✗ HEADSET	✓ MUTE	✓ VOLUME UP	✗ CONTACTS
✗ MESSAGE	✓ HOLD	✓ TRANSFER	✓ VOLUME DOWN	✗ CALL LOG
✓ DROP	✓ REDIAL	✓ CONFERENCE	✓ MENU	















Item	SAP Code
1603 IP PHONE	700415540
Accessories	
CAT5 Ethernet Cable (14 FT)	700383326
CAT5 Ethernet Cable (1FT)	700436710
1603 PLASTIC LABEL COVERS (10) - REPLACEMENT	700419831
1603 WEDGE STAND - REPLACEMENT	700415615
1600 SERIES HANDSET - REPLACEMENT	700427495
1600 SERIES 9' HANDSET CORD - REPLACEMENT (BLACK)	700429707
9600/1600 SERIES 25' HANDSET CORD (GREY)	700383821
Power Supply	
1603 PoE adapter	700415607
Power Adapter for 1600 IP Phones 5V US	700451230
Power Adapter for 1600 IP Phones 5V UK	700451248
Power Adapter for 1600 IP Phones 5V EU	700451255
Power Adapter for 1600 IP Phones 5V Argentina	700451263
Power Adapter for 1600 IP Phones 5V Korea	700451271
Power Adapter for 1600 IP Phones 5V China	700451289
Power Adapter for 1600 IP Phones 5V Australia	700451297
Power Adapter for 1600 IP Phones 5V (3 Prong) Israel	700459795
Paper Labels	
1603 PAPER DESI LABELS - PACKAGE OF 50 LABELS (8.5" x 11")	700415706
1603 PAPER DESI LABELS - PACKAGE OF 50 LABELS (A4)	700434210

11.8.2 1608

This phone is supported with IP Office 4.2 and higher.

1608	Feature	1608
	Connects via	IP network.
	IP Office Release	4.2 Q4 2008+
	Programmable Buttons	✓ 8
	Headset Socket	✓
	Handsfree Speaker/ Microphone	✓/✓
	Message Waiting Lamp	✓
	PoE Class/Typical Idle Power Consumption	Class 2 (4.7W)
	Display	3 x 24 backlit.
	Supported Add-Ons	None.
	Upgradeable Firmware	✓
PC Pass-Through Port/with Voice Priority	✓/✓	

Fixed Function Keys

✓  SPEAKER	✓  HEADSET	✓  MUTE	✓  VOLUME UP	✓  CONTACTS
✓  MESSAGE	✓  HOLD	✓  TRANSFER	✓  VOLUME DOWN	✓  CALL LOG
✓  DROP	✓  REDIAL	✓  CONFERENCE	✓  MENU	

Item	SAP Code
1608 IP PHONE	700415557
Accessories	
CAT5 Ethernet Cable (14 FT)	700383326
CAT5 Ethernet Cable (1FT)	700436710
1608 Wall Mount Kit (Includes 1ft ethernet cable)	700415623
1608 PLASTIC LABEL COVERS (10) - REPLACEMENT	700415664
1608 FLIP STAND - REPLACEMENT	700415714
1600 SERIES HANDSET - REPLACEMENT	700427495
1600 SERIES 9' HANDSET CORD - REPLACEMENT (BLACK)	700429707
9600/1600 SERIES 25' HANDSET CORD (GREY)	700383821
Power Supply	
1603 PoE adapter	700415607
Power Adapter for 1600 IP Phones 5V US	700451230
Power Adapter for 1600 IP Phones 5V UK	700451248
Power Adapter for 1600 IP Phones 5V EU	700451255
Power Adapter for 1600 IP Phones 5V Argentina	700451263
Power Adapter for 1600 IP Phones 5V Korea	700451271
Power Adapter for 1600 IP Phones 5V China	700451289
Power Adapter for 1600 IP Phones 5V Australia	700451297
Power Adapter for 1600 IP Phones 5V (3 Prong) Israel	700459795
Paper Labels	
1608 PAPER DESI LABELS - PACKAGE OF 50 LABELS (8.5" x 11")	700415649
1608 PAPER DESI LABELS - PACKAGE OF 50 LABELS (A4)	700434228

11.8.3 1616

This phone is supported with IP Office 4.2 and higher.

1616	Feature	1616
	Connects via	IP network.
	IP Office Release	4.2 Q4 2008+
	Programmable Buttons	✓ 16
	Headset Socket	✓
	Handsfree Speaker/Microphone	✓/✓
	Message Waiting Lamp	✓
	PoE Class/Typical Idle Power Consumption	Class 2
	Display	4 x 24 Backlit.
	Supported Add-Ons	BM32 x 1.
	Upgradeable Firmware	✓
PC Pass-Through Port/with Voice Priority	✓/✓	

Fixed Function Keys

✓ SPEAKER	✓ HEADSET	✓ MUTE	✓ VOLUME UP	✓ CONTACTS
✓ MESSAGE	✓ HOLD	✓ TRANSFER	✓ VOLUME DOWN	✓ CALL LOG
✓ DROP	✓ REDIAL	✓ CONFERENCE	✓ MENU	









Item	SAP Code
1616 IP PHONE	700415565
Accessories	
CAT5 Ethernet Cable (14 FT)	700383326
CAT5 Ethernet Cable (1FT)	700436710
1616 Wall Mount Kit (Includes 1ft ethernet cable)	700415631
1616/BM32 PLASTIC LABEL COVERS (20) - REPLACEMENT	700415672
1616 FLIP STAND - REPLACEMENT	700415722
1600 SERIES HANDSET - REPLACEMENT	700427495
1600 SERIES 9' HANDSET CORD - REPLACEMENT (BLACK)	700429707
9600/1600 SERIES 25' HANDSET CORD (GREY)	700383821
Power Supply	
1603 PoE adapter	700415607
Power Adapter for 1600 IP Phones 5V US	700451230
Power Adapter for 1600 IP Phones 5V UK	700451248
Power Adapter for 1600 IP Phones 5V EU	700451255
Power Adapter for 1600 IP Phones 5V Argentina	700451263
Power Adapter for 1600 IP Phones 5V Korea	700451271
Power Adapter for 1600 IP Phones 5V China	700451289
Power Adapter for 1600 IP Phones 5V Australia	700451297
Power Adapter for 1600 IP Phones 5V (3 Prong) Israel	700459795
Paper Labels	
1616/BM32 PAPER DESI LABELS - PACKAGE OF 50 LABELS (8.5" x 11")	700415656
1616/BM32 PAPER DESI LABELS - PACKAGE OF 50 LABELS (A4)	700434236

11.8.4 2402

In addition to the two physical programmable buttons, the  FEATURE key plus 0-9, * and # can be used to access an additional 12 programmable slots.

On IP Office, the 2402D display is not used.

2402D	Feature	Detail
	Connects via	DS port.
	IP Office Release	3.0+
	Programmable Buttons	✓ 2   *.
	Headset Socket	✗
	Handsfree Speaker/Microphone	✓/✗
	Message Waiting Lamp	✓
	Display	Not used.
	Supported Add-Ons	None.
	Upgradable Firmware	✓

Standard DCP Phone Keys			
✗  SPEAKER	✗  HEADSET	✓  MUTE	✓  VOLUME UP
✓  MESSAGES	✓  HOLD	✓  TRANSFER	✓  VOLUME DOWN
✓  DROP	✓  REDIAL	✓  CONFERENCE	

Variant	SAP Code	
2402D	Multi-Grey	700381973
Replacement Handset	Dark Grey	700203797
Amplified Handset	Dark Grey	700229735
Noisy Location Handset	Dark Grey	700229743
Push to Talk Handset	Dark Grey	700229727

11.8.5 2410

2410D	Feature	2410
	Connects via	DS port.
	IP Office Release	3.0+
	Programmable Buttons	✓ 12. (6 buttons x 2 pages).
	Headset Socket	✓
	Handsfree Speaker/Microphone	✓/✓
	Message Waiting Lamp	✓
	Display	29 characters x 5 lines. (168 x 80 pixels).
	Supported Add-Ons	None.
	Upgradable Firmware	✓





Standard DCP Phone Keys

✓  SPEAKER	✓  HEADSET	✓  MUTE	✓  VOLUME UP
✓  MESSAGES	✓  HOLD	✓  TRANSFER	✓  VOLUME DOWN
✓  DROP	✓  REDIAL	✓  CONFERENCE	

Variant		SAP Code
2410	Multi-Grey	700381999
Replacement Handset	Dark Grey	700203797
Amplified Handset	Dark Grey	700229735
Noisy Location Handset	Dark Grey	700229743
Push to Talk Handset	Dark Grey	700229727

11.8.6 2420

2420D	Feature	Details
	Connects via	DS port.
	IP Office Release	1.4+
	Programmable Buttons	✓ 24 (8 buttons x 3 pages)
	Headset Socket	✓
	Handsfree Speaker/Microphone	✓/✓
	Message Waiting Lamp	✓
	Display	29 characters x 7 lines.
	Supported Add-Ons	EU24*, 201B.
	Upgradable Firmware	✓

Standard DCP Phone Keys			
✓  SPEAKER	✓  HEADSET	✓  MUTE	✓  VOLUME UP
✓  MESSAGES	✓  HOLD	✓  TRANSFER	✓  VOLUME DOWN
✓  DROP	✓  REDIAL	✓  CONFERENCE	

2420	Multi-Grey	700381585
Replacement Handset	Dark Grey	700203797
Amplified Handset	Dark Grey	700229735
Noisy Location Handset	Dark Grey	700229743
Push to Talk Handset	Dark Grey	700229727
201B Recorder Interface Module		700381635
20B Stand		700381650
EU24*	Multi-Grey	700381817
1151D1 Power Supply	With CAT5 cable.	700434897
1151D2 Power Supply with battery backup.	With CAT5 cable.	700434905
1151D1/1151D2 Power Cord	USA	405362641
	Europe	407786623
	Australia/New Zealand	407786631
	India	407790991
	United Kingdom	407786599
	Argentina	408161453

*When used with an EU24 unit, a 1151 type power supply unit must be used to power the phone.

11.8.7 3616

This is an 802.11b WiFi phone. It connects to the IP Office via a wireless access point and Avaya Voice Priority Processor (AVPP).

3616	Feature	Detail
	Connects via	IP network.
	IP Office Release	2.0+
	Programmable Buttons	✓ 6.
	Headset Socket	✓
	Message Waiting Lamp	✗
	Upgradable Firmware	✗

Variant	SAP Code
3616 Wireless Phone	700413040
Additional battery pack for 3616	700277387
Desktop charger for 3616.	700412901
Clip for 3616	700413057
3616/3626 Configuration Cradle	700375934

11.8.8 3620

This is an 802.11b WiFi phone. It connects to the IP Office via a wireless access point and Avaya Voice Priority Processor (AVPP).

The 3620 is similar to the 3616 but has been designed for use in healthcare environments. It is waterproof and has a back lit display.

3616	Feature	Detail
	Connects via	IP network.
	IP Office Release	3.2+
	Programmable Buttons	✓ 6.
	Headset Socket	✓
	Message Waiting Lamp	✗
	Upgradable Firmware	✗

Variant	SAP Code
3620 Wireless Phone	700413065
Additional battery pack.	700277387
Desktop charger.	700412901
Clip	700413057
Configuration Cradle	700375934

11.8.9 3626

This phone is similar to the 3616 in functionality. However the 3626 has a ruggedized construction. This is an 802.11b WiFi phone. It connects to the IP Office via a wireless access point and Avaya Voice Priority Processor (AVPP).

3626	Feature	Detail
	Connects via	IP network.
	IP Office Release	2.0+
	Programmable Buttons	✓ 6.
	Headset Socket	✓
	Message Waiting Lamp	✗
	Upgradable Firmware	✗

Variant	SAP Code	
3626 Wireless Phone	700413024	
Additional battery pack for 3626	700277395	
Desktop charger for 3626	700412919	
3626 Gang changer	700412927	
Clip for 3626	700413131	
3626 Vinyl case with keypad cover	700412984	
3626 Carry case	Yellow	700289309
3626 Carry case with keypad cover	Black	700289317
	Yellow	700289325
3616/3626 Configuration Cradle	700375934	

11.8.10 3641

The Avaya 3641 IP Wireless Telephone is a WiFi telephone that runs using H.323.



The 3641 supports the following features:

- Lightweight innovative design .
- Simple to use.
- 802.11a, 802.11b and 802.11g standard-compatible.
- Transmission type Direct Sequence Spread Spectrum (DSSS).
- FCC certification Part 15.247.
- Management of telephones via DHCP and TFTP.
- Voice encoding G711.
- Wired Equivalent Privacy (WEP) - 40bit and 128 bit. WPA-PSK, WPA2-PSK.
- 5x16 character alphanumeric, plus status indicators.
- 4 hours talk time and 80 hours standby. Extendable with optional battery packs to 8 hours talk time and 160 hours standby.

11.8.11 3645

The Avaya 3645 IP Wireless Telephone is a WiFi telephone that runs using H.323.



The 3645 supports the following features:

- Lightweight innovative design .
- Simple to use.
- 802.11a, 802.11b and 802.11g standard-compatible.
- Transmission type Direct Sequence Spread Spectrum (DSSS).
- FCC certification Part 15.247.
- Management of telephones via DHCP and TFTP.
- Voice encoding G711.
- Wired Equivalent Privacy (WEP) - 40bit and 128 bit. WPA-PSK, WPA2-PSK.
- 5x16 character alphanumeric, plus status indicators.
- 4 hours talk time and 80 hours standby. Extendable with optional battery packs to 8 hours talk time and 160 hours standby.
- Can be enabled for Push-to-talk (walkie-talkie) feature for broadcast between employees.

11.8.12 3701

The 3701 is an Avaya DECT handset supported on IP Office when using Avaya IP DECT base stations.

3701	Feature	Detail
	Connects via	IP network
	IP Office Release	3.1+
	Programmable Buttons	✗
	Headset Socket	✗
	Handsfree Speaker/Microphone	✓/✗
	Message Waiting Lamp	✓
	Upgradable Firmware	✓

Variant	SAP Code	
3701	700346802	
Belt Clip	700346885	
Phone Charger	700346828	
Power Adaptor for Charger	European	700346836
	UK	700346844
	Australia	700378318
8-Phone Gang Charger	700346851	
Power Adaptor for Rack Mount Charger	Global	700346869

11.8.13 3711

The 3711 is an Avaya DECT handset supported on IP Office when using Avaya IP DECT base stations.

3711	Feature	Detail
	Connects via	IP network
	IP Office Release	3.1+
	Programmable Buttons	✗
	Headset Socket	✓
	Handsfree Speaker/Microphone	✓/✓
	Message Waiting Lamp	✓
	Upgradable Firmware	✓

Variant	SAP Code	
3711	700346810	
Belt Clip	700346885	
Phone Charger	700346828	
Power Adaptor for Charger	European	700346836
	UK	700346844
	Australia	700378318
8-Phone Gang Charger	700346851	
Power Adaptor for Rack Mount Charger	Global	700346869

11.8.14 3810

The phone uses a wireless 900MHz digital protocol to connect to its base station. The base station connects to an IP Office DS port. The base station also requires a power outlet socket. Additional power outlet sockets are required for the phone charger.

Depending on coverage overlap, between three and five 3810's can be connected to the same IP Office.



This phone is supported in North America only.

3810	Feature	Detail
	Connects via	DS port.
	IP Office Release	2.1+
	Programmable Buttons	✓ 4.
	Headset Socket	✓
	Handsfree Speaker/Microphone	✓/✓
	Message Waiting Lamp	✓
	Upgradable Firmware	✗



Item	SAP Code
3810 Set - Includes phone, base station, charger, belt clip and power supply units for charger and base station.	700305105

11.8.15 4406

This phone is supported in North America only (A-Law only). Not supported on the IP500 Digital Station card.

4406D+	Feature	Detail
	Connects via	DS port.
	IP Office Release	1.0+
	Programmable Buttons	✓ 6 
	Headset Socket	✓
	Handsfree Speaker/Microphone	✓ / ✓
	Message Waiting Lamp	✓
	Display	16 characters x 2 lines.
	Supported Add-Ons	None.
	Upgradable Firmware	✗

Standard DCP Phone Keys

✓  SPEAKER	✗  HEADSET	✓  MUTE	✓  VOLUME UP
✗  MESSAGES	✓  HOLD	✓  TRANSFER	✓  VOLUME DOWN
✗  DROP	✓  REDIAL	✓  CONFERENCE	











Item	SAP Code
4406D+ (Black)	108199027
4406D+ (White)	108199019
Small 4400 Series Stand (Black)	108541194
Stand 4400 Series Stand (White)	108541202

11.8.16 4412

This phone is supported in North America only (A-Law only). Not supported on the IP500 Digital Station card.

Note: A maximum of twenty-seven 4412D telephones are supported on the IP500 DS30 expansion modules and on IP400 DS30 (version 2) expansion module at PCS level 5. Earlier IP400 DS30 expansion modules will only support sixteen of these telephones.

4412D+	Feature	Detail
	Connects via	DS port.
	IP Office Release	1.0+
	Programmable Buttons	✓ 24 (12  /12 ).
	Headset Socket	✓
	Handsfree Speaker/ Microphone	✓/✓
	Message Waiting Lamp	✓
	Display	24 characters x 2 lines.
	Supported Add-Ons	4450 x 2.
	Upgradable Firmware	✗



Standard DCP Phone Keys			
✓  SPEAKER	✗  HEADSET	✓  MUTE	✓  VOLUME UP
✗  MESSAGES	✓  HOLD	✓  TRANSFER	✓  VOLUME DOWN
✗  DROP	✓  REDIAL	✓  CONFERENCE	











Item		SAP Code
4412D+	Black	108199050
	White	108199043
Large 4400 Series Stand for 4412D+/4424D+	Black	108541269
	White	108541277

11.8.17 4424

This phone is supported in North America only (A-Law only). Not supported on the IP500 Digital Station card.

Note: A maximum of twenty-seven 4424D telephones are supported on the IP500 DS30 expansion modules and on IP400 DS30 (version 2) expansion module at PCS level 5. Earlier IP400 DS30 expansion modules will only support sixteen of these telephones.

4424D+	Feature	Detail
	Connects via	DS ports.
	IP Office Release	1.0+
	Programmable Buttons	✓ 24   .
	Headset Socket	✓
	Handsfree Speaker/Microphone	✓/✓
	Message Waiting Lamp	✓
	Display	24 characters x 2 lines.
	Supported Add-Ons	4450 x 2.
	Upgradeable Firmware	✗

Standard DCP Phone Keys			
✓  SPEAKER	✗  HEADSET	✓  MUTE	✓  VOLUME UP
✗  MESSAGES	✓  HOLD	✓  TRANSFER	✓  VOLUME DOWN
✗  DROP	✓  REDIAL	✓  CONFERENCE	

Item		SAP Code
4424D+	Black	108199084
	White	108199076
Large 4400 Series Stand for 4412D+/4424D+	Black	108541269
	White	108541277
4450 DSS Add-On	Black	108199696
	White	108199407
Small 4400 Series Stand for 4450.	Black	108541194
	White	108541202
Power Supply for 4450		108596412

11.8.18 4601

This phone requires a separate power supply, using either a Avaya 1151D1 or 1151D2 power supply unit and power cord or an 802.3af Power over Ethernet (PoE) source. For RoHS compliance the 4601 has been replaced by the 4601+, however the two phones are functionally the same.

4601+	Feature	Detail
	Connects via	IP Network.
	IP Office Release	3.0+
	Programmable Buttons	✓ 2
	Headset Socket	✗
	Handsfree Speaker/Microphone	✗/✗
	Message Waiting Lamp	✓
	PoE Class/Typical Idle Power Consumption	3.5W (Class 2)
	Display	None.
	Supported Add-Ons	None.
	Upgradeable Firmware	✓
	PC Pass-Through Port/with Voice Priority	✗/✗

Standard DCP Phone Keys

✗  SPEAKER	✗  HEADSET	✓  MUTE	✓  VOLUME UP
✓  MESSAGES	✓  HOLD	✓  TRANSFER	✓  VOLUME DOWN
✓  DROP	✓  REDIAL	✓  CONFERENCE	



Variant		SAP Code
4601+	Multi-Grey	700381890
1151D1 Power Supply	With CAT5 cable.	700434897
1151D2 Power Supply with battery backup.	With CAT5 cable.	700434905
1151D1/1151D2 Power Cord	USA	405362641
	Europe	407786623
	Australia and New Zealand	407786631
	India	407790991
	United Kingdom	407786599
	Argentina	408161453
Replacement Handset	Dark Grey	700203797
Amplified Handset	Dark Grey	700229735
Noisy Location Handset	Dark Grey	700229743
Push to Talk Handset	Dark Grey	700229727

11.8.19 4602

These phones are similar in physical appearance and functions. However the 4602SW+ includes a PC data pass-through port which gives priority to phone traffic. The 4602IP is no longer available from Avaya.

The 4602SW+ is the RoHS compliant replacement for the 4602SW which is no longer available.

This phone requires a separate power supply, using either a Avaya 1151D1 or 1151D2 power supply unit and power cord or a 802.3af Power over Ethernet (PoE) source.

4602/4602SW	Feature	4602IP	4602SW+
	Connects via	IP network.	
	IP Office Release	1.3+	
	Programmable Buttons	✓ 2   *	
	Headset Socket	✗	
	Handsfree Speaker/Microphone	✓/✗	
	Message Waiting Lamp	✓	
	PoE Class/Typical Idle Power Consumption	3.5W (Class 2)	
	Display	24 characters x 2 lines.	
	Supported Add-Ons	None.	
	Upgradable Firmware	✓	
	PC Pass-Through Port/with Voice Priority	✗/✗	✓/✓

Standard DCP Phone Keys

✗  SPEAKER	✗  HEADSET	✓  MUTE	✓  VOLUME UP
✓  MESSAGES	✓  HOLD	✓  TRANSFER	✓  VOLUME DOWN
✓  DROP	✓  REDIAL	✓  CONFERENCE	

Variant		SAP Code
4602IP	Multi-Grey	700221260
4602SW+	Multi-Grey	700381916
1151D1 Power Supply	With CAT5 cable.	700434897
1151D2 Power Supply with battery backup.	With CAT5 cable.	700434905
1151D1/1151D2 Power Cord	USA	405362641
	Europe	407786623
	Australia and New Zealand	407786631
	India	407790991
	United Kingdom	407786599
	Argentina	408161453
	Replacement Handset	Dark Grey
Amplified Handset	Dark Grey	700229735
Noisy Location Handset	Dark Grey	700229743
Push to Talk Handset	Dark Grey	700229727

11.8.20 4610

This phone requires a separate power supply, using either a Avaya 1151D1 or 1151D2 power supply unit and power cord or a 802.3af Power over Ethernet (PoE) source.

4610SW	Feature	Detail
	Connects via	IP network.
	IP Office Release	3.0+
	Programmable Buttons	✓ 24 (6 buttons x 4pages).
	Headset Socket	✓
	Handsfree Speaker/Microphone	✓/✓.
	Message Waiting Lamp	✓
	PoE Class/Typical Idle Power Consumption	4.0W (Class 2)
	Display	29 characters x 5 lines (168 x 80 pixels)
	Supported Add-Ons	None.
	Upgradable Firmware	✓
	PC Pass-Through Port/with Voice Priority	✓/✓

Standard DCP Phone Keys			
✓  SPEAKER	✓  HEADSET	✓  MUTE	✓  VOLUME UP
✗  MESSAGES	✓  HOLD	✓  TRANSFER	✓  VOLUME DOWN
✓  DROP	✓  REDIAL	✓  CONFERENCE	

Variant	SAP Code	
4610SW	Multi-Grey	700381957
1151D1 Power Supply	With CAT5 cable.	700434897
1151D2 Power Supply with battery backup.	With CAT5 cable.	700434905
1151D1/1151D2 Power Cord.	USA	405362641
	Europe	407786623
	Australia and New Zealand	407786631
	India	407790991
	United Kingdom	407786599
	Argentina	408161453
Replacement Handset	Dark Grey	700203797
Amplified Handset	Dark Grey	700229735
Noisy Location Handset	Dark Grey	700229743
Push to Talk Handset	Dark Grey	700229727









11.8.21 4620

These phones are similar in physical appearance and functions. However the 4620SW's PC data pass-through port gives priority to phone traffic.

This phone requires a separate power supply, using either a Avaya 1151D1 or 1151D2 power supply unit and power cord or a 802.3af Power over Ethernet (PoE) source.

4620IP/4620SW	Feature	4620IP	4620SW
	Connects via	IP network.	
	IP Office Release	2.0+	
	Programmable Buttons	✓ 24 (12 buttons x 2 pages).	
	Headset Socket	✓	
	Handsfree Speaker/Microphone	✓/✓	
	Message Waiting Lamp	✓	
	PoE Class/Typical Idle Power Consumption	4W (Class 3)	5.9W (Class 3)
	Display	29 characters x 7 lines (168 x 132 pixels)	
	Supported Add-Ons	EU24*, EU24BL*.	
	Upgradeable Firmware	✓	
	PC Pass-Through Port/with Voice Priority	✓/✗	✓/✓

Standard DCP Phone Keys

✓  SPEAKER	✓  HEADSET	✓  MUTE	✓  VOLUME UP
✗  MESSAGES	✓  HOLD	✓  TRANSFER	✓  VOLUME DOWN
✓  DROP	✓  REDIAL	✓  CONFERENCE	

Variant		SAP Code
4620IP	Multi-Grey	700212186
4620SW	Multi-Grey	700259674
Replacement Handset	Dark Grey	700203797
Amplified Handset	Dark Grey	700229735
Noisy Location Handset	Dark Grey	700229743
Push to Talk Handset	Dark Grey	700229727
EU24	Multi-Grey	700381817
EU24BL	Multi-Grey	700381544
1151D1 Power Supply	With CAT5 cable.	700434897
1151D2 Power Supply with battery backup.	With CAT5 cable.	700434905
1151D1/1151D2 Power Cord	USA	405362641
	Europe	407786623
	Australia/New Zealand	407786631
	India	407790991
	United Kingdom	407786599
	Argentina	408161453

*When used with an EU24 or EU24BL unit, a 1151 type power supply unit must be used to power the phone.

11.8.22 4621

The 4621 is similar in physical appearance and function to the 4620SW. However the 4621SW includes a backlight function for the screen.

This phone requires a separate power supply, using either a Avaya 1151D1 or 1151D2 power supply unit and power cord or a 802.3af Power over Ethernet (PoE) source.

4621SW	Feature	4621SW
	Connects via	IP network.
	IP Office Release	3.0(577)+
	Programmable Buttons	✓ 24 (12 buttons x 2 pages).
	Headset Socket	✓
	Handsfree Speaker/Microphone	✓/✓
	Message Waiting Lamp	✓
	PoE Class/Typical Idle Power Consumption	5.75W (Class 2)
	Display	29 characters x 7 lines (168 x 132 pixels)
	Supported Add-Ons	EU24*, EU24BL*.
	Upgradeable Firmware	✓
	PC Pass-Through Port/with Voice Priority	✓/✓

Standard DCP Phone Keys			
✓ SPEAKER	✓ HEADSET	✓ MUTE	✓ VOLUME UP
✗ MESSAGES	✓ HOLD	✓ TRANSFER	✓ VOLUME DOWN
✓ DROP	✓ REDIAL	✓ CONFERENCE	

Variant		SAP Code
4621SW	Multi-Grey	700345192
Replacement Handset	Dark Grey	700203797
Amplified Handset	Dark Grey	700229735
Noisy Location Handset	Dark Grey	700229743
Push to Talk Handset	Dark Grey	700229727
EU24*	Multi-Grey	700381817
EU24BL*	Multi-Grey	700381544
1151D1 Power Supply	With CAT5 cable.	700434897
1151D2 Power Supply with battery backup.	With CAT5 cable.	700434905
1151D1/1151D2 Power Cord	USA	405362641
	Europe	407786623
	Australia/New Zealand	407786631
	India	407790991
	United Kingdom	407786599
	Argentina	408161453

*When used with an EU24 or EU24BL unit, a 1151 type power supply unit must be used to power the phone.

11.8.23 4625

The 4625 is similar in physical appearance and function to the 4621SW. However the 4625SW includes a color display.

This phone requires a separate power supply, using either a Avaya 1151D1 or 1151D2 power supply unit and power cord or a 802.3af Power over Ethernet (PoE) source.

4625SW	Feature	4625SW
	Connects via	IP network.
	IP Office Release	3.2+
	Programmable Buttons	✓ 24 (12 buttons x 2 pages).
	Headset Socket	✓
	Handsfree Speaker/Microphone	✓/✓
	Message Waiting Lamp	✓
	PoE Class/Typical Idle Power Consumption	6.45W (Class 3)
	Display	29 characters x 7 lines (168 x 132 pixels)
	Supported Add-Ons	EU24*, EU24BL*.
	Upgradeable Firmware	✓
	PC Pass-Through Port/with Voice Priority	✓/✓

Standard DCP Phone Keys

✓  SPEAKER	✓  HEADSET	✓  MUTE	✓  VOLUME UP
✗  MESSAGES	✓  HOLD	✓  TRANSFER	✓  VOLUME DOWN
✓  DROP	✓  REDIAL	✓  CONFERENCE	





Variant		SAP Code
4625SW	Multi-Grey	700381551
Replacement Handset	Dark Grey	700203797
Amplified Handset	Dark Grey	700229735
Noisy Location Handset	Dark Grey	700229743
Push to Talk Handset	Dark Grey	700229727
EU24*	Multi-Grey	700381817
EU24BL*	Multi-Grey	700381544
1151D1 Power Supply	With CAT5 cable.	700434897
1151D2 Power Supply with battery backup.	With CAT5 cable.	700434905
1151D1/1151D2 Power Cord	USA	405362641
	Europe	407786623
	Australia/New Zealand	407786631
	India	407790991
	United Kingdom	407786599
	Argentina	408161453











*When used with an EU24 or EU24BL unit, a 1151 type power supply unit must be used to power the phone.

11.8.24 5402

This phone is similar in physical appearance and functions to the 2402D. However the 5402 phone is only supported on IP Office.

In addition to the two physical programmable buttons, the  FEATURE key plus 0-9, * and # can be used to access an addition 12 programmable slots.

5402	Feature	Detail
	Connects via	DS port.
	IP Office Release	3.0+.
	Programmable Buttons	✓ 2    *.
	Headset Socket	✗
	Handsfree Speaker/Microphone	✓/✗
	Message Waiting Lamp	✓
	Display	24 characters x 2 lines.
	Supported Add-Ons	None.
	Upgradable Firmware	✓

Standard DCP Phone Keys			
✗  SPEAKER	✗  HEADSET	✓  MUTE	✓  VOLUME UP
✓  MESSAGES	✓  HOLD	✓  TRANSFER	✓  VOLUME DOWN
✓  DROP	✓  REDIAL	✓  CONFERENCE	

Variant		SAP Code
5402	Multi-Grey	700345309
Replacement Handset	Dark Grey	700203797
Amplified Handset	Dark Grey	700229735
Noisy Location Handset	Dark Grey	700229743
Push to Talk Handset	Dark Grey	700229727

11.8.25 5410

This phone is similar in physical appearance and functions to the 2410. However the 5410 phone is only supported on IP Office.

5410	Feature	Detail
	Connects via	DS port.
	IP Office Release	3.0+
	Programmable Buttons	✓ 12 (6 buttons x 2 pages).
	Headset Socket	✓
	Handsfree Speaker/Microphone	✓/✓
	Message Waiting Lamp	✓
	Display	29 characters x 5 lines. (168 x 80 pixels).
	Supported Add-Ons	None.
	Upgradable Firmware	✓







Standard DCP Phone Keys			
✓  SPEAKER	✓  HEADSET	✓  MUTE	✓  VOLUME UP
✓  MESSAGES	✓  HOLD	✓  TRANSFER	✓  VOLUME DOWN
✓  DROP	✓  REDIAL	✓  CONFERENCE	

Variant		SAP Code
5410	Multi-Grey	700345291
5410 (RoHS compliant)	Multi-Grey	700382005
Replacement Handset	Dark Grey	700203797
Amplified Handset	Dark Grey	700229735
Noisy Location Handset	Dark Grey	700229743
Push to Talk Handset	Dark Grey	700229727

11.8.26 5420

This phone is similar in physical appearance and functions to the 2420. However the 5420 is only supported on IP Office.

5420D	Feature	Detail
	Connects via	DS port.
	IP Office Release	3.0+
	Programmable Buttons	✓ 24 (8 buttons x 3 pages)
	Headset Socket	✓
	Handsfree Speaker/Microphone	✓/✓
	Message Waiting Lamp	✓
	Display	29 characters x 7 lines.
	Supported Add-Ons	EU24*, 201B.
	Upgradable Firmware	✓

Standard DCP Phone Keys			
✓  SPEAKER	✓  HEADSET	✓  MUTE	✓  VOLUME UP
✓  MESSAGES	✓  HOLD	✓  TRANSFER	✓  VOLUME DOWN
✓  DROP	✓  REDIAL	✓  CONFERENCE	

Variant		SAP Code
5420D	Multi-Grey	700339823
5420D (RoHS compliant)	Multi-Grey	700381627
Replacement Handset	Dark Grey	700203797
Amplified Handset	Dark Grey	700229735
Noisy Location Handset	Dark Grey	700229743
Push to Talk Handset	Dark Grey	700229727
201B Recorder Interface Module		700381635
20B Stand		700381650
EU24*	Multi-Grey	700381817
1151D1 Power Supply	With CAT5 cable.	700434897
1151D2 Power Supply with battery backup.	With CAT5 cable.	700434905
1151D1/1151D2 Power Cord	USA	405362641
	Europe	407786623
	Australia/New Zealand	407786631
	India	407790991
	United Kingdom	407786599
	Argentina	408161453











*When used with an EU24 unit, a 1151 type power supply unit must be used to power the phone.

11.8.27 5601

This phone is similar in physical appearance and functions to the 4601. However the 5601 phone is only supported on IP Office. The 5601+ is the RoHS compliant version that has replaced the previous 5601 IP model but is otherwise the same.

This phone requires a separate power supply, using either a Avaya 1151D1 or 1151D2 power supply unit and power cord or a 802.3af Power over Ethernet (PoE) source.

5601	Feature	Detail
	Connects via	IP Network.
	IP Office Release	3.0+
	Programmable Buttons	✓ 2
	Headset Socket	✗
	Handsfree Speaker/Microphone	✗/✗
	Message Waiting Lamp	✓
	PoE Class/Typical Idle Power Consumption	3.5W (Class 2)
	Display	None.
	Supported Add-Ons	None.
	Upgradeable Firmware	✓
	PC Pass-Through Port/with Voice Priority	✗/✗



Standard DCP Phone Keys			
✗  SPEAKER	✗  HEADSET	✓  MUTE	✓  VOLUME UP
✓  MESSAGES	✓  HOLD	✓  TRANSFER	✓  VOLUME DOWN
✓  DROP	✓  REDIAL	✓  CONFERENCE	











Variant		SAP Code
5601IP	Multi-Grey	700345366
5601+ (RoHS compliant)	Multi-Grey	700381908
Replacement Handset	Dark Grey	700203797
Amplified Handset	Dark Grey	700229735
Noisy Location Handset	Dark Grey	700229743
Push to Talk Handset	Dark Grey	700229727
1151D1 Power Supply	With CAT5 cable.	700434897
1151D2 Power Supply with battery backup.	With CAT5 cable.	700434905
1151D1/1151D2 Power Cord	USA	405362641
	Europe	407786623
	Australia/New Zealand	407786631
	India	407790991
	United Kingdom	407786599
	Argentina	408161453

11.8.28 5602

The 5602IP and 5602SW phones are similar in physical appearance and functions. However the 5602SW includes a PC data pass-through port which gives priority to phone traffic. The 5602IP is no longer available from Avaya. The 5602SW+ is the RoHS compliant version that has replaced the previous 5602SW model but is otherwise the same.

This phone requires a separate power supply, using either a Avaya 1151D1 or 1151D2 power supply unit and power cord or a 802.3af Power over Ethernet (PoE) source.

5602IP/5602SW	Feature	5602IP	5602SW
	Connects via	IP network.	
	IP Office Release	3.0+	
	Programmable Buttons	✓ 2   *	
	Headset Socket	✗	
	Handsfree Speaker/Microphone	✓/✗	
	Message Waiting Lamp	✓	
	PoE Class/Typical Idle Power Consumption	4.1W (Class 2)	
	Display	24 characters x 2 lines.	
	Supported Add-Ons	None.	
	Upgradable Firmware	✓	
PC Pass-Through Port/with Voice Priority	✗/✗	✓/✓	

Standard DCP Phone Keys			
✗  SPEAKER	✗  HEADSET	✓  MUTE	✓  VOLUME UP
✓  MESSAGES	✓  HOLD	✓  TRANSFER	✓  VOLUME DOWN
✓  DROP	✓  REDIAL	✓  CONFERENCE	

Variant		SAP Code
5602IP	Multi-Grey	700345341
5602SW	Multi-Grey	700381825
5602SW+ (RoHS compliant)	Multi-Grey	700381932
Replacement Handset	Dark Grey	700203797
Amplified Handset	Dark Grey	700229735
Noisy Location Handset	Dark Grey	700229743
Push to Talk Handset	Dark Grey	700229727
EU24	Multi-Grey	700381817
EU24BL	Multi-Grey	700381544
1151D1 Power Supply	With CAT5 cable.	700434897
1151D2 Power Supply with battery backup.	With CAT5 cable.	700434905
1151D1/1151D2 Power Cord	USA	405362641
	Europe	407786623
	Australia/New Zealand	407786631
	India	407790991
	United Kingdom	407786599
	Argentina	408161453

11.8.29 5610

This phone requires a separate power supply, using either a Avaya 1151D1 or 1151D2 power supply unit and power cord or a 802.3af Power over Ethernet (PoE) source.

5610	Feature	Detail
	Connects via	IP network.
	IP Office Release	3.0+
	Programmable Buttons	✓ 24 (6 buttons x 4 pages).
	Headset Socket	✓
	Handsfree Speaker/Microphone	✓/✓.
	Message Waiting Lamp	✓
	PoE Class/Typical Idle Power Consumption	5W (Class 2)
	Display	29 characters x 5 lines (168 x 80 pixels)
	Supported Add-Ons	None.
	Upgradable Firmware	✓
PC Pass-Through Port/with Voice Priority	✓/✓	

Standard DCP Phone Keys

✓  SPEAKER	✓  HEADSET	✓  MUTE	✓  VOLUME UP
✗  MESSAGES	✓  HOLD	✓  TRANSFER	✓  VOLUME DOWN
✓  DROP	✓  REDIAL	✓  CONFERENCE	

Variant		SAP Code
5610SW	Multi-Grey	700345333
5610SW (RoHS compliant)	Multi-Grey	700381965
Replacement Handset	Dark Grey	700203797
Amplified Handset	Dark Grey	700229735
Noisy Location Handset	Dark Grey	700229743
Push to Talk Handset	Dark Grey	700229727
EU24	Multi-Grey	700381817
EU24BL	Multi-Grey	700381544
1151D1 Power Supply	With CAT5 cable.	700434897
1151D2 Power Supply with battery backup.	With CAT5 cable.	700434905
1151D1/1151D2 Power Cord	USA	405362641
	Europe	407786623
	Australia/New Zealand	407786631
	India	407790991
	United Kingdom	407786599
	Argentina	408161453

11.8.30 5620

This phone is similar in physical appearance and functions to the 4620SW. It is no longer available from Avaya, having been replaced by the 5621.

This phone requires a separate power supply, using either a Avaya 1151D1 or 1151D2 power supply unit and power cord or a 802.3af Power over Ethernet (PoE) source.

5620	Feature	5620IP
	Connects via	IP network.
	IP Office Release	3.0+
	Programmable Buttons	✓ 24 (12 buttons x 2 pages).
	Headset Socket	✓
	Handsfree Speaker/Microphone	✓/✓
	Message Waiting Lamp	✓
	PoE Class/Typical Idle Power Consumption	5.9W (Class 3)
	Display	29 characters x 7 lines (168 x 132 pixels)
	Supported Add-Ons	EU24*, EU24BL*.
	Upgradeable Firmware	✓
PC Pass-Through Port/with Voice Priority	✓/✓	

Standard DCP Phone Keys			
✓ SPEAKER	✓ HEADSET	✓ MUTE	✓ VOLUME UP
✗ MESSAGES	✓ HOLD	✓ TRANSFER	✓ VOLUME DOWN
✓ DROP	✓ REDIAL	✓ CONFERENCE	

Variant		SAP Code
5620IP	Multi-Grey	700339815
Replacement Handset	Dark Grey	700203797
Amplified Handset	Dark Grey	700229735
Noisy Location Handset	Dark Grey	700229743
Push to Talk Handset	Dark Grey	700229727
EU24*	Multi-Grey	700381817
EU24BL*	Multi-Grey	700381544
1151D1 Power Supply	With CAT5 cable.	700434897
1151D2 Power Supply with battery backup.	With CAT5 cable.	700434905
1151D1/1151D2 Power Cord	USA	405362641
	Europe	407786623
	Australia/New Zealand	407786631
	India	407790991
	United Kingdom	407786599
	Argentina	408161453



*When used with an EU24 or EU24BL unit, a 1151 type power supply unit must be used to power the phone.

11.8.31 5621

This phone is similar in physical appearance and functions to the 4621SW.

This phone requires a separate power supply, using either a Avaya 1151D1 or 1151D2 power supply unit and power cord or a 802.3af Power over Ethernet (PoE) source.

5621	Feature	5620IP
	Connects via	IP network.
	IP Office Release	3.2+
	Programmable Buttons	✓ 24 (12 buttons x 2 pages).
	Headset Socket	✓
	Handsfree Speaker/Microphone	✓/✓
	Message Waiting Lamp	✓
	PoE Class/Typical Idle Power Consumption	5.9W (Class 3)
	Display	29 characters x 7 lines (168 x 132 pixels)
	Supported Add-Ons	EU24*, EU24BL*.
	Upgradeable Firmware	✓
PC Pass-Through Port/with Voice Priority	✓/✓	

Standard DCP Phone Keys			
✓  SPEAKER	✓  HEADSET	✓  MUTE	✓  VOLUME UP
✗  MESSAGES	✓  HOLD	✓  TRANSFER	✓  VOLUME DOWN
✓  DROP	✓  REDIAL	✓  CONFERENCE	







Variant		SAP Code
5621SW	Multi-Grey	700345982
5621SW (RoHS compliant)	Multi-Grey	700385982
Replacement Handset	Dark Grey	700203797
Amplified Handset	Dark Grey	700229735
Noisy Location Handset	Dark Grey	700229743
Push to Talk Handset	Dark Grey	700229727
EU24*	Multi-Grey	700381817
EU24BL*	Multi-Grey	700381544
1151D1 Power Supply	With CAT5 cable.	700434897
1151D2 Power Supply with battery backup.	With CAT5 cable.	700434905
1151D1/1151D2 Power Cord	USA	405362641
	Europe	407786623
	Australia/New Zealand	407786631
	India	407790991
	United Kingdom	407786599
	Argentina	408161453

*When used with an EU24 or EU24BL unit, a 1151 type power supply unit must be used to power the phone.

11.8.32 6408D

These phones no longer available from Avaya.

6408D	Feature	Detail
	Connects via	DS port.
	IP Office Release	1.0+.
	Programmable Buttons	✓ 8 
	Headset Socket	✗
	Handsfree Speaker/Microphone	✓/✓
	Message Waiting Lamp	✓
	Display	24 characters x 2 lines.
	Supported Add-Ons	None.
	Upgradable Firmware	✗











Standard DCP Phone Keys			
✓  SPEAKER	✗  HEADSET	✓  MUTE	✓  VOLUME UP
✗  MESSAGES	✓  HOLD	✓  TRANSFER	✓  VOLUME DOWN
✗  DROP	✓  REDIAL	✓  CONFERENCE	

Item	SAP Code
6408D+ (Grey)	70020100
6408D+ (White)	70020092
6408 Stand (Grey)	108933169
6408 Stand (White)	108933177

11.8.33 6416D

These phones no longer available from Avaya. An additional 24 programmable buttons can be added using an XM24 and power supply unit.



6416D	Feature	Detail
	Connects via	DS port.
	IP Office Release	1.0+.
	Programmable Buttons	✓ 16 
	Headset Socket	✓
	Handsfree Speaker/Microphone	✓/✓
	Message Waiting Lamp	✓
	Display	24 characters x 2 lines.
	Supported Add-Ons	XM24
	Upgradable Firmware	✗

Standard DCP Phone Keys			
✓  SPEAKER	✓  HEADSET	✓  MUTE	✓  VOLUME UP
✗  MESSAGES	✓  HOLD	✓  TRANSFER	✓  VOLUME DOWN
✓  DROP	✓  REDIAL	✓  CONFERENCE	

Variant		SAP Code
6416D+M	Grey	108807611
	White	108807603
6416/6424D+M Stand	Grey	848219127
	White	848219119
XM24	Grey	700406523
	White	700406515
XM24 Stand	Grey	108272378
	White	108272386
1151D1 Power Supply	With CAT5 cable.	700434897
1151D2 Power Supply with battery backup.	With CAT5 cable.	700434905
1151D1/1151D2 Power Cord	USA	405362641
	Europe	407786623
	Australia and New Zealand	407786631
	India	407790991
	United Kingdom	407786599
	Argentina	408161453

11.8.34 6424D

An additional 24 programmable buttons can be added using an XM24 and power supply unit.

6424D	Feature	Detail
	Connects via	DS port.
	IP Office Release	1.0+.
	Programmable Buttons	✓ 24  .
	Headset Socket	✓
	Handsfree Speaker/Microphone	✓/✓
	Message Waiting Lamp	✓
	Display	24 characters x 2 lines.
	Supported Add-Ons	XM24
	Upgradeable Firmware	✗

Standard DCP Phone Keys			
✓  SPEAKER	✓  HEADSET	✓  MUTE	✓  VOLUME UP
✗  MESSAGES	✓  HOLD	✓  TRANSFER	✓  VOLUME DOWN
✓  DROP	✓  REDIAL	✓  CONFERENCE	

Variant	SAP Code	
6424D+M	Grey	108807595
	White	108807587
6416/6424D+M Stand	Grey	848219127
	White	848219119
XM24	Grey	700406523
	White	700406515
XM24 Stand	Grey	108272378
	White	108272386
1151D1 Power Supply	With CAT5 cable.	700345447
1151D2 Power Supply with battery backup.	With CAT5 cable.	700345454
1151D1/1151D2 Power Cord.	USA	405362641
	Europe	407786623
	Australia and New Zealand	407786631
	India	407790991
	United Kingdom	407786599
	Argentina	408161453

11.8.35 T3 Classic

This phone is supported in Europe only (U-Law only). The T3 Classic has 2 Link ports for optional add-on T3 Headset and or T3 DSS units (up to 2 further T3 DSS units can be chained from the first T3 DSS).

The IP Office supports T3 UPN and IP phones. It does not support T3 IPN phones. Previous restrictions against using T3 phones on systems with other types of digital stations no longer apply.

T3 Classic	Feature	Detail
	Connects via	DS port.
	IP Office Release	3.1+. [Not Small Office Edition]
	Programmable Buttons	✓ 4.
	Headset Socket*	✓
	Handsfree Speaker/Microphone	✓/✓
	Message Waiting Lamp	✓
	Upgradeable Firmware	✗

*Using optional T3 Headset Link unit.

Variant	Colour	SAP Code
T3 UPN Classic	Black	700380272
	White	700380306
T3 IP Classic	Black	700414733
	White	700414725
T3 DSS Unit	Black	700380322
	White	700380330
T3 DSS Expansion Unit	Black	700380348
	White	700380355
T3 IP Power Supply Unit		700414766
AEI/Headset Link for T3 IP		700414774
Power Supply for T3 IP DSS		700414790
Headset Link for T3 UPN		700380363

11.8.36 T3 Comfort

This phone is supported in Europe only (U-Law only). The T3 Classic has 2 Link ports for optional add-on T3 Headset and or T3 DSS units (up to 2 further T3 DSS units can be chained from the first T3 DSS).

The IP Office supports T3 UPN and IP phones. It does not support T3 IPN phones. Previous restrictions against using T3 phones on systems with other types of digital stations no longer apply.

T3 Comfort	Feature	T3 Comfort
	Connects via	DS ports.
	IP Office Release	3.1+ [Not Small Office Edition]
	Programmable Buttons	✓ 10.
	Headset Socket*	✓
	Handsfree Speaker/Microphone	✓/✓
	Message Waiting Lamp	✓
	Upgradeable Firmware	✗

*Using optional T3 Headset Link unit.

Variant	Colour	SAP Code
T3 UPN Comfort	Black	700380280
	White	700380314
T3 IP Comfort	Black	700414758
	White	700414741
T3 DSS Unit	Black	700380322
	White	700380330
T3 DSS Expansion Unit	Black	700380348
	White	700380355
T3 IP Power Supply Unit		700414766
AEI/Headset Link for T3 IP		700414774
Power Supply for T3 IP DSS		700414790
Headset Link for T3 UPN		700380363

11.8.37 T3 Compact

This phone is supported in Europe only (U-Law only). The T3 Classic has 1 Link port for optional add-on T3 Headset or T3 DSS units (up to 2 further T3 DSS units can be chained from the first T3 DSS).

The IP Office supports T3 UPN and IP phones. It does not support T3 IPN phones. Previous restrictions against using T3 phones on systems with other types of digital stations no longer apply.

T3 Compact	Feature	T3 Compact
	Connects via	DS ports.
	IP Office Release	3.1+ [Not Small Office Edition]
	Programmable Buttons	✓ 10.
	Headset Socket	✓
	Handsfree Speaker/Microphone	✓/✓
	Message Waiting Lamp	✓
	Upgradeable Firmware	✗

*Using optional T3 Headset Link unit.

Variant	Colour	SAP Code
T3 UPN Compact	Black	700380264
	White	700380298
T3 IP Compact	Black	700414717
	White	700414709
T3 DSS Unit	Black	700380322
	White	700380330
T3 DSS Expansion Unit	Black	700380348
	White	700380355
T3 IP Power Supply Unit		700414766
AEI/Headset Link for T3 IP		700414774
Power Supply for T3 IP DSS		700414790
Headset Link for T3 UPN		700380363

11.9 Phone Add-Ons



11.9.1 4450

The DSS4450 works in association with the 4412D and 4424D telephones, each of which can support up to two DSS4450 adjuncts.

Each DSS4450 provides an additional 60 programmable keys with single red lamps except for the bottom two rows which have green lamps. The DSS4450 requires an auxiliary Avaya power supply unit and must be used with the cables supplied.

IP Office supports a maximum two 4450 units on each Digital Station expansion module, including the IP406 V2 control unit.

This phone is not supported on the IP500 DS8 Extension Card. For the IP500 it will work on external Digital Station Expansion Modules.

4450	Feature	Detail
	Connects via	DSS port on phone.
	Supported by	4424D+
	Maximum per phone	2.
	Maximum per IP Office	2.
	Additional requirements	4450 power supply unit on phone.
	IP Office Release	1.0+
	Programmable Buttons	✓ 60 (50x  / 10x ).

Item	SAP Code
4450 (Black)	108199696
4450 (White)	108199407
Small 4400 Series Stand (Black)	108541194
Small 4400 Series Stand (White)	108541202
Power Supply for 4450	108596412

11.9.2 BM32

This add on provides an additional 32 twin-LED programmable buttons for 1616 phones. The BM32 does not require its own power supply connection, instead it draws power from the phone to which it is connected.

- Up to 1 BM32 units can be connected in a chain from a single 1616.
- To support a BM32 the phone must be powered by an individual 1600 Series Power Adapter.
- Up to a maximum of 16 BM32 units are supported on the whole IP Office system.
- The BM32 buttons cannot be used for appearance functions such as call and line appearances.

Item	SAP Code
BM32 BUTTON MODULE	700415573
Accessories	
1600 SERIES BM32 CABLE - REPLACEMENT	700415581
1600 SERIES BM32 BOND BRIDGE - REPLACEMENT	700415599
1616/BM32 PLASTIC LABEL COVERS (20) - REPLACEMENT	700415672
1600 SERIES BM32 FLIP STAND - REPLACEMENT	700432800
Paper Labels	
1616/BM32 PAPER DESI LABELS - PACKAGE OF 50 LABELS (8.5" x 11")	700415656
1616/BM32 PAPER DESI LABELS - PACKAGE OF 50 LABELS (A4)	700434236

11.9.3 EU24

Provides an additional 24 programmable buttons.

- ⚠ Only the cable supplied with the EU24/EU24BL should for connection to the EU24/EU24BL. This cable should only be connected to the port marked EU24 on suitable phones. Doing otherwise will cause damage to the EU24/EU24BL and the equipment to which it is attached.

EU24	Feature	Detail
	Connects via	EU24 port on phone.
	Supported by	2420, 4620, 4621, 4625, 5420, 5620, 5621.
	Maximum per phone	1.
	Maximum per IP Office	8.
	Additional Requirements	A 1151 Type power supply unit must be used to power the phone.
	IP Office Release	3.0+
	Programmable Buttons	✔ 24.

Item		SAP Code
EU24 1XU-A Expansion Module	Multi-Grey	700381817
1151D1 Power Supply	With CAT5 cable.	700434897
1151D2 Power Supply with battery backup.	With CAT5 cable.	700434905
1151D1/1151D2 Power Cord	USA	405362641
	Europe	407786623
	Australia/New Zealand	407786631
	India	407790991
	United Kingdom	407786599
	Argentina	408161453

11.9.4 EU24BL

Provides an additional 24 programmable buttons. The EU24BL is physically similar to the EU24 but includes a backlight function that matches 4621 phone.

- ⚠ Only the cable supplied with the EU24/EU24BL should for connection to the EU24/EU24BL. This cable should only be connected to the port marked EU24 on suitable phones. Doing otherwise will cause damage to the EU24/EU24BL and the equipment to which it is attached.

EU24BL	Feature	Detail
	Connects via	EU24 port on phone.
	Supported by	4620, 4621, 4625, 5620, 5621.
	Maximum per phone	1.
	Maximum per IP Office	8.
	Additional requirements	A 1151 Type power supply unit must be used to power the phone.
	IP Office release	3.1+.
	Programmable Buttons	✔ 24.

Item		SAP Code
EU24BL 2XU-A Backlighted Expansion Module	Multi-Grey	700381544
1151D1 Power Supply	With CAT5 cable.	700434897
1151D2 Power Supply with battery backup.	With CAT5 cable.	700434905
1151D1/1151D2 Power Cord	USA	405362641
	Europe	407786623
	Australia/New Zealand	407786631
	India	407790991
	United Kingdom	407786599
	Argentina	408161453

11.9.5 T3 DSS

The T3 DSS provides an additional 36 programmable keys for phones in the supported T3 series. The T3 DSS is moulded and designed to be attached to the associated phone. Signalling is achieved by cable connection to the Link port on the T3 phone. A further two T3 DSS units can be chained from the first T3 DSS.

Feature	Detail
Connects via	Link port on phone.
Supported by	T3 Compact, T3 Classic, T3 Comfort
Maximum per phone	3.
Maximum per DS module	-.
Additional requirements	None.
IP Office release	3.1+.
Programmable Buttons	✓ 36.

Item	Colour	SAP Code
T3 DSS Unit	Black	700380322
	White	700380330
T3 DSS Expansion Unit	Black	700380348
	White	700380355

11.9.6 201B RIM

The 201B Recorder Interface Module (RIM) is supported for use with 2420 and 5420 phones. It provides the phone with a 3.5mm mini-RCA jack socket for connection of recording devices. It also provides two headset sockets which can be used in place of the phones existing headset socket (the phone and the RIM sockets can not be used at the same time).

- The 201B is the RoHS compliant replacement for the 201A. The 20B stand is the RoHS complaint replacement for the 20A stand.

To install the 201B, the phones existing stand must be removed and be replace by a 20B stand (also called the 20B Module Adapter Base). This is an expanded stand that includes two slots, into one of which the 201B can be inserted. However only one 201B is supported per phone.

Use of the 20B and therefore the 201B requires the phone to be powered by a 1151D1 or 1151D2 power supply unit. Full installation instructions are included with the 20B Stand.

Item		SAP Code
201B Recorder Interface Module		700381635
20B Stand		700381650
EU24	Multi-Grey	700381817
1151D1 Power Supply	With CAT5 cable.	700434897
1151D2 Power Supply with battery backup.	With CAT5 cable.	700434905
1151D1/1151D2 Power Cord	USA	405362641
	Europe	407786623
	Australia/New Zealand	407786631
	India	407790991
	United Kingdom	407786599
	Argentina	408161453

11.9.7 XM24

Connects to the XM24 port on the base of 6416 and 6424 phones. Requires the phone to have a separate power supply using an Avaya 1151D1 or 1151D2 power supply unit and a power outlet socket are required.

XM24	Feature	XM24
	Connects via	XM24 port on phone.
	Supported by	6416+, 6424+
	Maximum per phone	1.
	Maximum per IP Office	2.
	Additional requirements	1151D1 or 1151D2 PSU for phone.
	IP Office Release	1.0+.
	Programmable Buttons	✓ 24.

Item		SAP Code
XM24	Grey	700406523
	White	700406515
XM24 Stand	Grey	108272378
	White	108272386
1151D1 Power Supply.	With CAT5 cable.	700434897
1151D2 Power Supply with battery backup.	With CAT5 cable.	700434905
1151D1/1151D2 Power Cord	USA	405362641
	Europe	407786623
	Australia and New Zealand	407786631
	India	407790991
	United Kingdom	407786599
	Argentina	408161453

11.10 Applications

This section outline the requirements for various IP Office applications. These are just outlines, for full details refer to the specific installation manuals indicated and to the IP Office Technical Bulletins.

11.10.1 Call Status

This is a simple application that shows current calls in progress on the IP Office system. It is intended for use by IP Office installers and maintainers. It has been replaced by the [System Status Application](#) and is included in the IP Office Admin suite to assist with maintenance of pre-4.0 IP Office systems.

Details	
CD	IP Office 4.2 User and Admin CD Set (700459332)
DVD	IP Office 4.2 Applications DVD (700459340)
IP500	Call status is not supported with IP Office 4.0 and therefore not supported on IP500 systems.
License	✗ No license required.

PC Requirements

Minimum PC Requirements	
RAM	64MB
Hard Disk Free Space	50MB
Processor:	
- Pentium	PIII 800MHz
- Celeron	Celeron 3 800Mhz
- AMD	Athlon B 65-0MHz

Operating System Support	
Server OS:	
2000 Server	✗
2003 Server	✓
2008 Server	✗
Client OS:	
2000 Professional	✗
XP Professional	✓
Vista Business/Enterprise	✓
Vista Ultimate	✓

Ports

Component	Location - %ProgramFiles%\Avaya\IP Office\	Ports
Call Status	CallStatus\callstatus.exe	UDP 50798.

11.10.2 Compact Business Center (CBC)

This is a licensed application. It receives data from the [IP Office Delta Server](#) application. The CBC is able to show details of calls handled by up to 3 selected hunt groups. It can also display details of IP Office trunk usage. The CBC retains call details for 31 days.

Details	
CD	-
DVD	Compact Contact Center 5.2 DVD (700451545)
IP500	✓ IP Office Standard Edition, ✓ IP Office Professional Edition.
License	✓ Compact Business Center (IP400 CBC - 171993)

PC Requirements

Minimum PC Requirements	
RAM	256MB
Hard Disk Free Space	10GB
Processor:	
- Pentium	PIII 800Mhz
- Celeron	Celeron 3 800Mhz
- AMD	Athlon B 650Mhz
Additional Apps:	
- Delta Server	Required on same PC or subnet.

Operating System Support	
Server OS:	
2000 Server	✗
2003 Server	✓
2008 Server	✗
Client OS:	
2000 Professional	✗
XP Professional	✓
Vista Business/Enterprise	✓
Vista Ultimate	✓

Ports

Component	Location - %ProgramFiles%\Avaya\IP Office\	Ports
CBC	CCC\CBC\CBC.exe	

11.10.3 Compact Contact Center (CCC)

CCC is a reporting application designed for use in call centers. It provides a range of both real-time and historical reporting options. CCC consists of CCC Server applications that receive call information from the IP Office Delta Server, and a number of client applications for the display of that information. CCC and its clients are controlled by a range of licenses entered into the IP Office configuration.

The CCC server applications are listed below. Typically they are installed onto the same PC:

- **CCC Archiver**
The Archiver manages the collection and storage of call activity information.
- **Wallboard Server**
Wallboards provide current information on the number of calls waiting, response times and service levels. Wallboard Manager provides the ability to control both physical wallboards and PC wallboards. The Wallboard server must be installed on the same PC as the Delta Server.

The CCC clients are:

- **Call Center View (CCV):**
Provides a realtime information about call center activity.
- **Alarm Reporter:**
Provides real-time and past 7-days information on alarms that have occurred within the call center.
- **PC Wallboard:**
The PC Wallboard allows call center agents and supervisors to display real-time call center performance information on their Windows PC screen.
- **Report Manager:**
Provides in depth historical reporting on calls, agents and groups.
- **Workforce Management:**
This application allows CCC to share information with a third-party agent scheduling application - Blue Pumpkin.

Details	
CD	-
DVD	Compact Contact Center 5.2 DVD (700451545)
IP500	✗ IP Office Standard Edition, ✓ IP Office Professional Edition.
License	✓ Licensed application. See below.
Additional	Delta Server installed.

PC Requirements

Minimum PC Requirements						XP Pro	Vista	2000 Pro	2000 Server	2003 Server
Variant	RAM	HD	Pentium	Celeron	AMD					
CCC Server	512MB	10GB	Pentium 4 2.8GHz	1.7GHz	Athlon XP 3000+ All Athlon64 chips.	✗	✗	✗	✓	✓
" plus VMPro	512MB	30GB*	Pentium 4 2.8GHz.	Not tested.	Athlon XP 3000 + All Athlon 64	✗	✗	✗	✓	✓
Wallboard Server	128MB	10GB	Pentium 3 800Mhz	Celeron 3 800Mhz	Athlon B 650MHz	✓	✗	✓	✗	✗
Wallboard Client	128MB*	10GB	PIII 800MHz	Celeron 3 800MHz	Athlon B 650Mhz	✓	✗	✓	✗	✗
PC Wallboard						✓	✗	✓	✗	✗
Call Center View (CCV)						✓	✗	✓	✗	✗
CCC Reporter	Any PC with Internet Explorer 6.0 or higher.					✓	✗	✓	✓	✓

- If VM Pro and CCC are run on the same server, CCC is limited to up to a maximum of 25 agents, 8 ports of VM Pro and on Windows server operating systems only.
- *For all voicemail servers, also allow 1MB per minute for messages and greeting storage.
- *For Windows XP minimum RAM 256MB.
- The Wallboard Server MUST reside on the same PC as the Delta Server. Any Dual Core CPU of 1.8Ghz and higher is supported.

Ports

Component	Location - %ProgramFiles%\Avaya\IP Office\	Ports	Ports
Archiver	CCC\Archiver\ArchiverSQL.exe	TCP 8081. TCP 8082. TCP 8083. TCP 8084. TCP 8085. TCP 8086. TCP 8087. TCP 8088. TCP 8089.	UDP 8081. UDP 8082. UDP 8083. UDP 8084. UDP 8085. UDP 8086. UDP 8087. UDP 8088. UDP 8089.
CCV	CCC\CallCentreView\CallCentreView.exe		
CCC Alarm Reporter	CCC\CCVAlarmReporter\CCVAlarmReporter.exe		
Wallboard DBMGR	CCC\DBMgr\DBMgr.exe		
PC Wallboard	CCC\PCWallboard\PCWallboard.exe		TCP 2127. UDP 2127.
CCC Reporter Admin	CCC\Reporting\Admin.exe	TCP 8081. TCP 8082. TCP 8083. TCP 8084. TCP 8085. TCP 8086. TCP 8087. TCP 8088. TCP 8089.	UDP 8081. UDP 8082. UDP 8083. UDP 8084. UDP 8085. UDP 8086. UDP 8087. UDP 8088. UDP 8089. UDP 50800.
CCC Reporter	CCC\Reporting\bin\CCCReporter.exe		
CCC User Access	CCC\User Access\CCCUserAccess.exe		
Wallboard Server	CCC\WBServer\WbServer32.exe		TCP 2127. UDP 2127.

Licenses

License	Description	RFA Name	SAP
CCC Server	Enables the CCC Server applications (Archiver and Wallboard Manager) with support for 1 supervisor, reporting on 5 agents, and one PC Wallboard. <ul style="list-style-type: none"> This license is a pre-requisite for all the following CCC licensing. 	CCC SVR	171994
CCC Agents	Enables various numbers of additional agents (5, 10, 20, 50) for CCC reporting.	CCC AGT	5 171995
			10 174469
			20 174470
			50 174471
CCC Supervisors	Enables additional supervisors (1, 5, 10, 20) up to the maximum of 21 supported supervisors. Each supervisor also allows reporting on 5 agents and one instance of a PC Wallboard.	CCC SUP	1 171996
		" 5	5 184730
		" 10	10 184731
		" 20	20 184732
CCC PC Wallboards	Enables additional CCC PC Wallboards for 5, 10, 20, 50 agents.	CCC PCW	5 172786
		" 10	10 174472
		" 20	20 174473
		" 50	50 174474
CCC Spectrum Wallboards	Enables the operation of between 4 Spectrum wallboards (not Ferrograph). Licenses are cumulative up to a maximum of 16 wallboards.	CCC Wallboard	4 176196
Report Viewer	Allows additional users (5, 10, 20) access to historic reports.	CCC Report	5 184726
			10 184727
			20 184728
CCC Agent Rostering	Enables the Agent Rostering Interface for CCC which provides connection to a 3rd party Agent Rostering package (Blue Pumpkin).	CCC Rostering	171997
CCC Designer (users)	Enables CCC Report Designer, which permits a supervisor to design and customize their own reports. One license per user. Note: requires the user to have Crystal Report Writer software.	CCC Designer	171999

11.10.4 Conference Center

This is a server application that is accessed via web browser. It allows users with a conference center password to book conferences. Details of the people to invite to a conference can be entered and those people set to receive either an email invite or, using [IP Office Voicemail Pro](#), a call asking them to join the conference.

Access to the conference center for configuration and conference booking is via web browser.

Details	
CD	IP Office Conference Center 4.0 (700428576)
DVD	IP Office 4.2 Applications DVD (700459340)
IP500	✗ IP Office Standard Edition, ✓ IP Office Professional Edition.
License	✓ Conferencing Center (IP400 Conferencing Center RFA - 182302)
Languages	English, French, German, Italian, Latin Spanish, Swedish.

PC Requirements

Minimum PC Requirements	
RAM	512MB
Hard Disk Free Space	80GB
Processor:	
- Pentium	P4 2.8GHz
- Celeron	Not tested.
- AMD	Athlon XP 3000+, Athlon64
Additional Apps:	
- Web Browser	Internet Explorer 6.0 or higher.

Operating System Support	
Server OS:	
2000 Server	✓
2003 Server	✓
2008 Server	✗
Client OS:	
2000 Professional*	✓
XP Professional	✗
Vista Business/Enterprise	✗
Vista Ultimate	✗

- Client PC: For conference booking and web conference access any Windows PC running Internet Explorer 6.0 or higher.
- For conversion of files to .MHT format, Microsoft Office is required on the client PC.
- When IP Office Conferencing Center is installed, 5 conference slots are reserved by the IP Office control unit for its own use (call recording, etc) and are not available to IP Office Conferencing Center or for general conference usage.
- Windows XP Professional, 2000 Professional can be used but would typically support a maximum of 10 web clients. To support more than 10 clients a server with IIS will be required. Any Dual Core CPU of 2.4Ghz and higher is supported.

Ports

Component	Location - %ProgramFiles%\Avaya\IP Office\	Ports
Conference Center	ECSConference\ConferenceService.exe	ALL 50801. ALL 8089. UDP 50791. UDP 50795.

11.10.5 ContactStore

The Voicemail Pro can be used for manual and automatic call recording. Normally those recordings are placed into the mailbox specified for the user or hunt group whose call is being recorded and are then treated as normal messages.

Contact Store allows those recordings to be redirected into a database on the ContactStore PC. This allows recordings to be archived and searched separately from user messages. This application requires entry of a license into the IP Office configuration.

User access to the Contact Store is via web browser. Internet 6.0 or higher is supported.

Details	
CD	IP Office Voicemail Pro 4.2 CD's (700459357) (2nd CD contains ContactStore)
DVD	IP Office 4.2 Applications DVD (700459340)
IP500	✗ IP Office Standard Edition, ✓ IP Office Professional Edition.
License	✓ VMPro Recordings Administrators (IP400 ContactStore for IPO RFA - 187166)

PC Requirements

Minimum PC Requirements	
RAM	512MB
Hard Disk Free Space	10GB*
Processor:	
- Pentium	P4 2.4GHz
- Celeron	Not tested.
- AMD	Athlon XP 3000+, Athlon64
Additional Apps:	
- Web Browser	Internet Explorer 6.0 or higher.

Operating System Support	
Server OS:	
2000 Server	✓
2003 Server	✓
2008 Server	✗
Client OS:	
2000 Professional	✓
XP Professional	✓
Vista Business/Enterprise	✗
Vista Ultimate	✗

- If run on the same PC as the Voicemail Pro, apart from meeting the requirements of Voicemail Pro:
 - ContactStore must use a separate disk partition from Voicemail Pro.
 - Minimum hard disk free space increases to 20GB* and Pentium processor to P4 2.8GHz minimum.
- *1: For all voicemail servers, also allow 1MB per minute for messages and greeting storage.
- *2: Also allow 7.2MB per hour for recordings in the Contact Store disk partition.
- Recordings and data are stored in an MSDE database. This is created during installation of the Contact Store software.

Ports

Component	Location - %ProgramFiles%\Avaya\IP Office\	Ports
Contact Store	Witness\tomcat5024\bin\tomcat5.exe	TCP 8888. UDP 50791. UDP 50795.

11.10.6 Delta Server

Applications such as CCC and CBC do not communicate directly with the IP Office system. They communicate across the LAN with a PC running the IP Office Delta Server application. This application receives call information from the IP Office systems which it then shares with other applications. The Delta Server does not require a license in the IP Office configuration. Only one Delta Server can be used with each IP Office system.

Delta Server installs as a Windows service. Access to the application is through web browser on the PC to the address <http://localhost:8080>.

• Delta Server SMDR Output

The Delta server can be configured to output a call log of all calls made and received by the IP Office system. This is called a SMDR call log. The Delta server send these records to an SMDR file stored on the PC and which can then be accessed by 3rd-party call logging applications. The Delta Server can also send SMDR records to a remote IP address. Note that IP Office 4.2+ systems can send SMDR direct from the IP Office control unit to an IP address without requiring the Delta Server application.

Details	
CD	IP Office 4.2 User and Admin CD Set (700459332)
DVD	IP Office 4.2 Applications DVD (700459340)
IP500	✓ IP Office Standard Edition, ✓ IP Office Professional Edition.
License	✗ No license required.
Languages	Brazilian Portuguese, English (UK), English (US), Dutch, French, French Canadian, Italian, Latin Spanish, Spanish.

PC Requirements

Minimum PC Requirements	
RAM	256MB
Hard Disk Free Space	10GB
Processor:	
- Pentium	PIII 800MHz
- Celeron	Any 1.7GHz
- AMD	Any 1.4GHz
Additional Apps:	
- Web Browser	Internet Explorer 6.0 or higher.

Operating System Support	
Server OS:	
2000 Server	✗
2003 Server	✓
2008 Server	✓
Client OS:	
2000 Professional	✗
XP Professional	✓
Vista Business/Enterprise	✗
Vista Ultimate	✗

Ports

Component	Location - %ProgramFiles%\Avaya\IP Office\	Ports
Delta Server PWA	CCC\DeltaServer\DeltaServerHTTPPasswordAssistant.exe	
SMDR CR	CCC\DeltaServer\SMDRClientResponse.exe	
SMDR SR	CCC\DeltaServer\SMDRServerResponse.exe	
Delta Server Service V5	CCC\DeltaServer\DeltaServerService.exe	TCP 8080. UDP 50800.
Delta Server Service Management Assistant V5	CCC\DeltaServer\DeltaServerManagementAssistant.exe	

11.10.7 Feature Key Server

This application is required for IP Office systems where licenses are being validated against a parallel or USB port Feature Key dongle. It must be installed on the same PC as the dongle. The application installs as a service and appears as an icon in the PC's system tray. It has no configuration settings.

Feature key server is not required for IP Office systems with a serial port dongle attached directly to the IP Office control unit or for IP500 systems.

Details	
CD	IP Office 4.2 User and Admin CD Set (700459332)
DVD	IP Office 4.2 Applications DVD (700459340)
IP500	This application is no required for the IP500.
License	✗ No license required.

PC Requirements

Minimum PC Requirements	
RAM	256MB
Hard Disk Free Space	1MB
Processor:	
- Pentium	PIII 800MHz
- Celeron	Celeron 3 800Mhz
- AMD	Athlon B 650MHz
Additional Apps:	

Operating System Support	
Server OS:	
2000 Server	✗
2003 Server	✓
2008 Server	✗
Client OS:	
2000 Professional	✗
XP Professional	✗
Vista Business/Enterprise	✗
Vista Ultimate	✗

Ports

Component	Location - %ProgramFiles%\Avaya\IP Office\	Ports
Feature Key Server	KeyServe\keyserve.exe	UDP 50800.

11.10.8 Manager

This tool is used to access all parts of the IP Office configuration. Different levels of access can be defined to control which parts of the configuration the Manager user can view and alter. Manager is also used to upgrade the software files used by an IP Office system. When running is also acts as a TFTP server from which some Avaya phones can request new software.

Note that IP Office Manager's software level is always two higher than the IP Office core software with which it is release. For example IP Office 4.0 core software is release with IP Office Manager 6.0.

IP Office Manager 6.2 is backwards compatible and can be used to manage IP Office systems running software from IP Office 2.1 upwards.

Details	
CD	IP Office 4.2 User and Admin CD Set (700459332)
DVD	IP Office 4.2 Applications DVD (700459340)
IP500	✓ IP Office Standard Edition, ✓ IP Office Professional Edition.
Languages	English, Brazilian, Dutch, French, German, Italian, Spanish (Mexican).
License	✗ No license required.

PC Requirements

Minimum PC Requirements	
RAM	256MB
Hard Disk Free Space	1GB*
Processor:	
- Pentium	PIII 800MHz
- Celeron	Celeron 3 800Mhz
- AMD	Athlon Opteron, Athlon64/XP
Additional Apps:	
- .NET2	Installed with Manager if not already present.

Operating System Support	
Server OS:	
2000 Server	✗
2003 Server	✓
2008 Server	✓
Client OS:	
2000 Professional	✗
XP Professional	✓
Vista Business/Enterprise	✓
Vista Ultimate	✓

*Includes disk space required for .NET2 component.

Ports

Component	Location - %ProgramFiles%\Avaya\IP Office\	Ports
IP Office Manager	Manager\manager.exe	TCP Port 50802. TCP Port 50804. TCP Port 50812. UDP Port 50798.
IP Office Upgrade Wizard	Manager\upgradewiz.exe	UDP Port 50798.

11.10.9 Monitor

Monitor (also known as System Monitor) is a tool that can show all activity on the IP Office system in great detail. As a consequence, interpretation of Monitor traces requires a high-level of data and telephony protocol knowledge. However, all IP Office installers and maintainers must understand how to run Monitor when necessary as Avaya may request copies of Monitor traces to resolve support issues.

For IP Office 4.0 and higher, the [System Status Application](#) has been added to provide more easily interpreted information than is provided by Monitor.

- Two versions of Monitor are included in the IP Office Admin applications suite, one for IP Office 4.0 systems and one for pre-4.0 IP Office systems. Care should be taken to ensure that the correct version is used when monitoring an IP Office system.

Details	
CD	IP Office 4.2 User and Admin CD Set (700459332)
DVD	IP Office 4.2 Applications DVD (700459340)
IP500	✓ IP Office Standard Edition, ✓ IP Office Professional Edition.
Languages	English only.
License	✗ No license required.

PC Requirements

Minimum PC Requirements	
RAM	128MB
Hard Disk Free Space	10GB
Processor:	
- Pentium	PIII 800MHz
- Celeron	Celeron 3 800Mhz
- AMD	Athlon B 650MHz
Additional Apps:	

Operating System Support	
Server OS:	
2000 Server	✗
2003 Server	✓
2008 Server	✓
Client OS:	
2000 Professional	✗
XP Professional	✓
Vista Business/Enterprise	✓
Vista Ultimate	✓

Ports

Component	Location - %ProgramFiles%\Avaya\IP Office\	Ports
System Monitor	Monitor\sysmonitor.exe	UDP 50794.

11.10.10 MS-CRM

The Avaya IP Office MS-CRM component allows the IP Office system to be used to make and receive calls for users using the Microsoft MS-CRM application.

Details	
CD	IP Office 4.2 User and Admin CD Set (700459332)
DVD	IP Office 4.2 Applications DVD (700459340)
Languages	English.
IP500	✗ IP Office Standard Edition, ✓ IP Office Professional Edition.
License	✓ License application. See below.

PC Requirements: Server

Minimum PC Requirements	
RAM	128MB
Hard Disk Free Space	10GB
Processor:	
- Pentium	P4 2.4Ghz
- Celeron	Not tested.
- AMD	Not tested.
Additional Apps:	
- MS Dynamics CRM3.0	
- IIS 5.0+.	

Operating System Support	
Server OS:	
2000 Server	✓
2003 Server	✓
2008 Server	✗
Client OS:	
2000 Professional	✗
XP Professional	✗
Vista Business/Enterprise	✗
Vista Ultimate	✗

PC Requirements: Client

Minimum PC Requirements	
RAM	512MB
Hard Disk Free Space	10GB
Processor:	
- Pentium	P4 1.4Mhz
- Celeron	Not tested.
- AMD	Not tested.
Additional Apps:	
- .NET2	Installed by IP Office MS-CRM software if not detected.
- IP Office TAPI 2.1	

Operating System Support	
Server OS:	
2000 Server	✗
2003 Server	✗
Client OS:	
2000 Professional	✓
XP Professional	✓
Vista Business/Enterprise	✗
Vista Ultimate	✗

Licenses

License	Description	RFA Name	SAP
MS-CRM	Enables IP Office support for MS-CRM.	IP400 Microsoft CRM Intgr	180588

11.10.11 Phone Manager

Phone Manager is an application that allows the user to control and monitor their own phone through their PC. For Avaya phone's that support handsfree operation, Phone Manager can be used to make and answer calls. During usage, the Phone Manager records details of calls made, answered and missed. It can also be configured to show the status of other users on the system. Phone Manager also allows the user to access and change many of the setting stored in the IP Office configuration that relate to their own phone operation, for example their forwarding destination numbers.

Though installed as a single set of software, that same software can operate in several modes:

- **Phone Manager Lite**

The default mode of Phone Manager. Requires no license, this application can be installed for any IP Office user.

- **Phone Manager Pro**

Users configured for Professional Edition mode are able to access a range of additional features. Phone manager Pro requires entry of licenses into the IP Office system. The licenses also control the number of simultaneous Phone Manager Pro users. The user's Phone Manager software then automatically changes from Lite mode to Professional Edition mode.

- **Phone Manager Pro PC Softphone** (formerly called *Phone Manager iPro*)

This is a PC softphone mode of Phone Manager operation. The user acts as a VoIP extension, making calls through the speaker and microphone of their PC. This mode requires further licenses in addition to the Phone Manager Pro licenses.

Details	
CD	IP Office 4.2 User and Admin CD Set (700459332)
DVD	IP Office 4.2 Applications DVD (700459340)
Languages	Brazilian, Chinese (Simplified), Danish, Dutch, English, French, Finnish, German, Italian, Korean, Latin Spanish, Norwegian, Portuguese, Russian, Spanish, Swedish.
IP500	✓ IP Office Standard Edition, ✓ IP Office Professional Edition.
License	✓ License application. See below.

PC Requirements

Minimum PC Requirements	
RAM	64MB
Hard Disk Free Space	160MB for Lite/1GB for Pro.
Processor:	
- Pentium	PIII 800MHz
- Celeron	Celeron 3 800Mhz
- AMD	Athlon B 650MHz
Additional Apps:	

Operating System Support	
Server OS:	
2000 Server	✗
2003 Server	✗
2008 Server	✗
Client OS:	
2000 Professional	✗
XP Professional	✓
Vista Business/Enterprise	✓
Vista Ultimate	✓

- Phone Manager Pro PC Softphone also requires the user PC to have a speaker and microphone installed and the user associated with an IP extension on the IP Office.

Ports

Component	Location - %ProgramFiles%\Avaya\IP Office\	Ports
Phone Manager	Phone Manager\PhoneManager.exe	UDP 50796. UDP 50799.
Phone Manager VOIP Server	Phone Manager\iClaritySvr.exe	UDP 1719. UDP 1720.

Licenses

License	Description	RFA Name	SAP	
Phone Manager Pro (per user)	Enables Phone Manager Pro for 1, 5, 10, 20, 50, 100 or unlimited users. The user's Phone Manager mode is set through the IP Office configuration (User Telephony Phone Manager Type).	IP400 Phone Manager Pro	1	177468
			5	177469
			10	177470
			20	177471
			50	177472
			100	177473
			unlimited	177474
Phone Manager Pro IP Audio Enabled (per user)	Enables Phone Manager Pro IP softphone operation for a user. Note: Also requires the user to have a Phone Manager Pro license.	IP400 IPPRO	1	171992
			5	174463
			10	174464
			20	174465
			50	174466
			100	174467

11.10.12 SoftConsole

This is a licensed application. It is intended for telephone system operators or receptionists. It displays details of calls directed to the user and allows them to quickly see the status of the callers required destination and transfer the call. The SoftConsole user is able to access a range of details about the status of users and groups on the IP Office system.

- The IP Office SoftConsole works in conjunction with a physical IP Office extension phone to provide the speech path for calls. It is not supported for use with an IP softphone.
- Up to 4 simultaneous SoftConsole users can be licensed.

Details	
CD	IP Office 4.2 User and Admin CD Set (700459332)
DVD	IP Office 4.2 Applications DVD (700459340)
Languages	Brazilian, Chinese (Simplified), Danish, Dutch, English, French, Finnish, German, Italian, Korean, Latin Spanish, Norwegian, Portuguese, Russian, Spanish, Swedish.
IP500	✔ IP Office Standard Edition, ✔ IP Office Professional Edition.
License	✔ License application. See below.

PC Requirements

Minimum PC Requirements	
RAM	128MB
Hard Disk Free Space	1GB
Processor:	
- Pentium	PIII 800MHz
- Celeron	Celeron 3 800Mhz
- AMD	Athlon B 650MHz
Additional Apps:	

Operating System Support	
Server OS:	
2000 Server	✗
2003 Server	✗
2008 Server	✗
Client OS:	
2000 Professional	✗
XP Professional	✔
Vista Business/Enterprise	✔
Vista Ultimate	✔

Ports

Component	Location - %ProgramFiles%\Avaya\IP Office\	Ports
SoftConsole	SoftConsole\SoftConsole.exe	UDP 50799. UDP 50796.

Licenses

License	Description	RFA Name	SAP
SoftConsole (users)	Adds one additional SoftConsole user. A maximum of four SoftConsole user can be licensed.	IP400 SoftConsole	171987

11.10.13 System Status Application (SSA)

This tool provides a wide range of information about the current status of an IP Office 4.0 or higher system. It includes available resources and components within the system. This includes details of current call in progress. Details of the number of alarms are recorded and the time date of the most recent alarms.

When required for diagnostics escalation SSA is able to take a snap shot image of the IP Office system's status including a copy of its current configuration.

Use of SSA requires an IP Office service user name and password that has been configured for System Status access in the IP Office's security settings.

Details	
CD	IP Office 4.2 User and Admin CD Set (700459332)
DVD	IP Office 4.2 Applications DVD (700459340)
IP500	✓ IP Office Standard Edition, ✓ IP Office Professional Edition.
License	✗ No license required.

PC Requirements

Minimum PC Requirements	
RAM	256MB
Hard Disk Free Space	1.4GB
Processor:	
- Pentium	PIII 800MHz
- Celeron	Celeron 3 800Mhz
- AMD	Athlon B 650MHz
Additional Apps:	
- Sun Java Virtual Machine	Installed with SSA if not already present.

Operating System Support	
Server OS:	
2000 Server	✗
2003 Server	✓
2008 Server	✓
Client OS:	
2000 Professional	✗
XP Professional	✓
Vista Business/Enterprise	✓
Vista Ultimate	✓

11.10.14 TAPI

IP Office TAPI is a client PC application that allows TAPI compliant applications to interact with the IP Office. The IP Office TAPI software can be used in one of two modes, depended on whether it is licensed or not. The same software is installed in either case with the licenses, if any, being entered in the IP Office system configuration.

- **1st Party TAPI**

In this unlicensed mode the TAPI software supports control of an individual user's associated extension, allowing a TAPI compliant application to answer (requires a phone that supports handsfree answer) and make calls.

- **3rd Party TAPI**

In this licensed mode, TAPI software can be used to control call function on multiple user extension. This mode is used with CTI Developer applications.

Details	
CD	IP Office 4.2 User and Admin CD Set (700459332)
DVD	IP Office 4.2 Applications DVD (700459340)
IP500	✓ IP Office Standard Edition, ✓ IP Office Professional Edition.
License	✗ Optional. Licenses are required for 3rd party TAPI mode operation.

PC Requirements: 1st Party TAPI

Minimum PC Requirements	
RAM	64MB
Hard Disk Free Space	50MB
Processor:	
- Pentium	PIII 800MHz
- Celeron	Celeron 3 800Mhz
- AMD	Athlon B 65-0MHz

Operating System Support	
Server OS:	
2000 Server	✗
2003 Server	✗
2008 Server	✗
Client OS:	
2000 Professional	✗
XP Professional	✓
Vista Business/Enterprise	✓
Vista Ultimate	✓

PC Requirements: 3rd Party TAPI

Minimum PC Requirements	
RAM	64MB
Hard Disk Free Space	50MB
Processor:	
- Pentium	PIII 800MHz
- Celeron	Celeron 3 800Mhz
- AMD	Athlon B 65-0MHz

Operating System Support	
Server OS:	
2000 Server	✗
2003 Server	✓
Client OS:	
2000 Professional	✗
XP Professional	✓
Vista Business/Enterprise	✓
Vista Ultimate	✓

Ports

Component	Location - %ProgramFiles%\Avaya\IP Office\	Ports
TAPI2	TAPI\tspi2w.tsp	UDP 50797.

Licenses

License	Description	RFA Name	SAP
CTI Link Pro	Enables CTI Link Pro functionality (TAPI Link Pro and DEVLink Pro).	IP400 CTI	171988
Wave User	Allows streaming of WAV files, using TAPILink Pro, for 3rd party voice applications. This is a per user license.	IP400 TAPI WAV	177466

	Note that TAPI WAV calls use system data channels taken from the same pool as used for voicemail ports. The maximum number of simultaneous TAPI WAV user calls and voicemail users is determined by the IP Office control unit type; Small Office Edition = 10, IP406 = 20, IP412 = 30, IP Office 500 = 30.		
--	---	--	--

11.10.15 VoiceMail Lite

This application does not require an IP Office license. It can be installed from the IP Office Administrator Applications CD to a Windows PC on the IP Office LAN. It provides voicemail operation for all IP Office users and groups, using the PC hard-disk to store prompts and messages. Only 4 simultaneous connections to leave or play messages are supported.

Details	
CD	IP Office 4.2 User and Admin CD Set (700459332)
DVD	IP Office 4.2 Applications DVD (700459340)
Languages	Chinese (Mandarin), Danish, German, Greek, English UK), English (US), Spanish, Latin Spanish, Finnish, French, French Canadian, Hungarian, Italian, Korean, Dutch, Norwegian, Polish, Portuguese, Brazilian, Swedish.
IP500	✗ IP Office Standard Edition, ✓ IP Office Professional Edition.
License	✗ No license required.

PC Requirements

Minimum PC Requirements	
RAM	256MB
Hard Disk Free Space	2GB*
Processor:	
- Pentium	P4 1.4GHz.
- Celeron	Celeron 1.7GHz
- AMD	Any 1.4GHz

- *Also allow 1MB per minute for message and prompt storage.

Operating System Support	
Server OS:	
2000 Server	✗
2003 Server	✓
2008 Server	✓
Client OS:	
2000 Professional	✗
XP Professional	✓
Vista Business/Enterprise	✓
Vista Ultimate	✓

Ports

Component	Location - %ProgramFiles%\Avaya\IP Office\	Ports
Voicemail Lite	Voicemail Server\VMLite.exe	UDP 50791.

11.10.16 VoiceMail Pro

This application requires various licenses entered into the IP Office configuration to control the features it offers and the number of simultaneous connections, up to 30 on the IP412 and IP500 control units. The operation of Voicemail Pro can be customized to provide special services.

The Voicemail Pro software can be installed as separate Voicemail Pro client and server parts. This allows the remote administration of the Voicemail Pro server from a PC with just the Voicemail Pro client installed. A copy of the client is automatically installed locally with the Voicemail Pro server.

Source	
CD	IP Office Voicemail Pro 4.2 CD's (700459357) ScanSoft TTS CD's (700293921)
DVD	IP Office 4.2 Applications DVD (700459340)
Languages	Chinese (Mandarin and Cantonese), Danish, German, Greek, English (UK), English (US), Spanish, Latin Spanish, Finnish, French, French Canadian, Hungarian, Italian, Korean, Dutch, Norwegian, Polish, Portuguese, Brazilian, Swedish.
IP500	✗ IP Office Standard Edition, ✓ IP Office Professional Edition.
License	✓ See below.

The Voicemail Pro server part of the software consists of several components in addition to the core server software, these are:

- Campaigns**
 The Voicemail Pro can be configured to run a campaign. This consists of a series of questions for which the Voicemail Pro records the callers answer or key presses. The resulting recordings can then be played back by users. The web aspect of campaigns allows user to perform this playback and processing of campaign recordings via their web browser. This requires an IIS web server to be run on the same PC as the Voicemail Pro software.
- Text to Speech (TTS)**
 Through adding additional licenses, the Voicemail Pro is able to use the TTS functions of Windows to speak text and numbers to callers in addition to recording prompts. This is intended mainly for scenarios where the Voicemail Pro is obtaining text and number values from a customer database.
- Integrated Messaging Service (IMS)**
 Both Voicemail Pro and Voicemail Lite support a feature called voicemail email to send messages or message alerts to a users email. This however is a one-way process. IMS allows this to become a two-way process, where users can play voicemail messages through their email mailbox or voicemail mailbox. IMS interoperates with the customer's Exchange server and the user's Outlook.

Basic Voicemail Pro

Minimum PC Requirements	
RAM	256MB
Hard Disk Free Space	2GB*
Processor:	
- Pentium	P4 1.4GHz
- Celeron	Any 1.7GHz
- AMD	Any 1.4GHz.

*Also allow 1MB per minute for message and prompt storage.

Operating System Support	
Server OS:	
2000 Server	✗
2003 Server	✓
2008 Server	✓
Client OS:	
2000 Professional	✗
XP Professional	✓
Vista Business/Enterprise	✓
Vista Ultimate	✓

Voicemail Pro plus UMS Web Voicemail and/or Campaigns

Minimum PC Requirements	
RAM	512MB
Hard Disk Free Space	2GB*
Processor:	
- Pentium	P4 2.8GHz
- Celeron	Not tested.
- AMD	Athlon XP 3000+, Athlon 64

Operating System Support	
Server OS:	
2000 Server	✗
2003 Server	✓
2008 Server	✓
Client OS:	
2000 Professional	✗

*Also allow 1MB per minute for message and prompt storage.

XP Professional	✗
Vista Business/Enterprise	✗
Vista Ultimate	✗

- Both Web Campaigns and UMS Web Voicemail require the IIS web server on the voicemail server PC to be enabled.
- UMS Web Voicemail will install PHP if not detected as already installed.
- UMS (IMAP or Web Voicemail) cannot be installed if IMS is installed and vice versa.

Voicemail Pro plus IMS

Minimum PC Requirements	
RAM	512MB
Hard Disk Free Space	2GB*
Processor:	
- Pentium	P4 2.8GHz
- Celeron	Not tested.
- AMD	Athlon XP 3000+, Athlon 64

Operating System Support	
Server OS:	
2000 Server	✗
2003 Server	✓
2008 Server	✗
Client OS:	
2000 Professional	✗
XP Professional	✗
Vista Business/Enterprise	✗
Vista Ultimate	✗

*Also allow 1MB per minute for message and prompt storage.

Non OS Applications	IMS
Microsoft Exchange 2000	Yes
Microsoft Exchange 2003	Yes
Microsoft Exchange 2007	Yes
Microsoft Outlook 2003	Yes
Microsoft Outlook 2007	No

Voicemail Pro plus IVR and or TTS

Minimum PC Requirements: Basic Voicemail Pro	
RAM	512MB
Hard Disk Free Space	20GB*
Processor:	
- Pentium	P4 2.8GHz
- Celeron	Not tested.
- AMD	Athlon XP 3000+, Athlon 64

Operating System Support	
Server OS:	
2000 Server	✗
2003 Server	✓
2008 Server	✓
Client OS:	
2000 Professional	✗
XP Professional	✓
Vista Business/Enterprise	✓*
Vista Ultimate	✓*

Also allow 1MB per minute for message and prompt storage.

*Generic TTS only. The current ScanSoft TTS provided with Voicemail Pro is not supported on Vista.

- If the database being queried is located on the VM Pro server the query speed of the database will be affected by the amount of memory available. Please take into account the memory requirements of the database being queried.

Voicemail Pro plus Compact Call Center

Minimum PC Requirements: Basic Voicemail Pro	
RAM	512MB
Hard Disk Free Space	10GB*
Processor:	
- Pentium	P4 2.8GHz
- Celeron	Not tested.
- AMD	Athlon XP 3000+, Athlon 64

Operating System Support	
Server OS:	
2000 Server	✗
2003 Server	✓
2008 Server	✓
Client OS:	
2000 Professional	✗

Also allow 1MB per minute for message and prompt storage.

XP Professional	✗
Vista Business/Enterprise	✗
Vista Ultimate	✗

- VM Pro and CCC can be run on the same server up to a maximum of 25 agents, 8 ports of VM Pro. Any Dual Core CPU of 2.4Ghz and higher is supported.

Ports

Component	Location - %ProgramFiles%\Avaya\IP Office\	Ports
Voicemail Pro Service	Voicemail Pro\VM\vmprov5svc.exe	UDP 50791. UDP 50795. ALL 50801. ALL 8089.
VMP Pro Database	Voicemail Pro\VM\VMPDBSvc.exe	
VPIM Client	Voicemail Pro\VPIMClient.exe	
VMP Pro VPIM DBSVR	Voicemail Pro\VPIM\vpimdbsvr.exe	
VMP Pro VPIM Receiver	Voicemail Pro\VPIM\VPIMReceiver.exe	
VMP Pro VPIM Server	Voicemail Pro\VPIM\VPIMServer3.exe	
IMS Admin	Voicemail Pro\IMS\IMSAdmin.exe	
IMS Service Restart	Voicemail Pro\IMS\IMSServiceRestart.exe	
IMS Gateway Service	Voicemail Pro\IMS\UMServer.exe	TCP 445. TCP 593. UDP 445. UDP 593
IMS Voice Service	Voicemail Pro\IMS\VMServer.exe	
IMS Security	Voicemail Pro\VM\IMSSec.exe	
IMS Client for Outlook	%ProgramFiles%\Avaya\IMS Client\UMSForm.exe	TCP 445. TCP 593. UDP 445. UDP 593.

Licenses

License	Description	RFA Name	SAP	
AUDIX Voicemail	Enables IP Office to use a remote Intuity Audix or Modular Messaging for voicemail. Does not require a local Voice Mail Pro server.	IP400 AUDIX	177467	
Voicemail Pro (4 ports)	Enables Voicemail Pro plus 4 ports.	IP400 Voicemail Pro	171991	
Additional Voicemail Pro (ports)	Adds additional ports (2, 4, 8 or 16) to an existing Voicemail Pro, up to the maximum number of ports supported by the IP Office control unit type. Maximum: Small Office Edition = 10, IP406 V2 = 20, IP412 = 30, IP500 = 30.	IP400 Voicemail Pro	2	174459
			4	174460
			8	174461
			16	174462
Networked Messaging	Enables VPNM (Voicemail Pro Networked Messaging) functionality within Voicemail Pro. This allows message exchange with remote Voicemail Pro systems and Avaya Interchange systems.	IP400 Networked Messaging	182297	
Integrated Messaging	Enables IMS Pro operation with Voicemail Pro. Enables synchronization to MS Exchange email systems with a form within Outlook to control voicemail playback.	IP400 Integrated Messaging Pro	171990	
VMPRO TTS (Scansoft)	Enables use of text to speech facilities using Avaya supplied TTS software with Voicemail Pro. One license per simultaneous instance of TTS usage.	IP400 Avaya TTS	182299	
VMPRO TTS (Generic)	Enables use of text to speech facilities using third party TTS software with Voicemail Pro. One license per simultaneous instance of TTS usage.	IP400 3rd Party TTS	182303	
VMPRO VB Script	Enables VB Script functionality with Voicemail Pro.	IP400 VB Scripting	182300	
VMPRO Database Interface	Enables 3rd party database support within Voicemail Pro call flows.	IP400 3rd Party IVR	182298	
VMPRO Recordings Administrators	Enables integration between Voicemail Pro and the Avaya Contact Store for IP Office application. ContactStore can be run unlicensed from the date of the first recorded call.	IP400 ContactStore for IPO	187166	
UMS Web Services	Enables use of UMS Web Voicemail and IMAP for users to access their mailbox. Licensed UMS Web Services users who hot desk to a remote system remain licensed against their home IP Office system.	IPO LIC VMPRO UMS 1	1	217880
			5	217881
			10	217882
			20	217884
			50	217885

11.10.17 IP Office Ports

Most PC firewalls will request the user to allow various exceptions when a newly installed application is first run. However this may not always be the case, especially if the firewall is located elsewhere than the user's PC.

Adding Firewall Exceptions

The file avayafw.bat can be used to open up the necessary firewall exceptions for IP Office applications. The file can be downloaded from <http://marketingtools.avaya.com/knowledgebase/tools/firewall>.

It only works for:

- The default Windows XP/Windows 2003 firewall.
- The application must be installed for the exception to be created.
- The application must be installed in the default location.

Whilst avayafw.bat only works subject to the conditions above, for other firewalls study of this file will indicate the necessary application files and ports for which exceptions need to be created.

Ports Used

The list below details many of the IP ports used by IP Office control units and IP Office applications. Many of these are standard ports for different IP traffic protocols.

◀ Indicates a listening port on the IP Office control unit. ▶ indicates a port to which the IP Office sends, for example to a PC running an IP Office application.

* Indicates that the port and or protocol can be changed.

Port		Protocol		Function
25*	▶	SMTP	TCP	Email system alarms from the IP Office to SMTP server. For IP Office 4.2 also used for Voicemail Email on Embedded Voicemail.
37	▶	Time	UDP	Time requests from the IP Office to a Time Server (RFC868).
53	◀	DNS	UDP	Domain Name Service responses.
67	◀	BOOTP/DHCP	UDP	DHCP server operation.
68	▶	BOOTP/DHCP	UDP	DHCP client operation.
69	◀	TFTP	UDP	File requests to the IP Office.
69	▶	TFTP	UDP	File requests by the IP Office.
161*	◀	SNMP	UDP	From SNMP applications.
162*	▶	SNMP Trap	UDP	To addresses set in the IP Office configuration.
500	◀	IKE	UDP	Key exchange for IPSec protocol.
389*	▶	LDAP	TCP	Lightweight Directory Access Protocol.
520	▶	RIP	UDP	To and from the IP Office to other RIP devices. For RIP1 and RIP2 (RIP1 compatible) the destination address is a subnet broadcast, eg. 192.168.42.255. For RIP2 Multicast the destination address is 224.0.0.9.
520	◀	RIP	UDP	
1701	◀	L2TP	UDP	Layer 2 tunneling protocol.
1718	◀	H.323	UDP	H.323 Discovery
1719	◀	H.323 RAS	UDP	H.323 Status. VoIP device registering with the IP Office.
1720	▶	H.323/H.245	UDP	H.323 Signalling. Data to a registered VoIP device.
2127	▶	(UDP)	UDP	PC Wallboard to CCC Wallboard Server.
3478	▶	SIP	UDP	Port used for STUN requests from the IP Office to the SIP provider.
5060	◀▶	SIP	UDP/ TCP*	SIP Line Signalling
8080	▶	HTTP	TCP	Browser access to the Delta Server application.
8089	▶	Enconf	UDP	From the IP Office to the Conferencing Center Server Service. User access to the conference center is direct via HTTP sessions.
8888	▶	HTTP	TCP	Browser access to the IP Office ContactStore (VRL) application.
49152 to 53247 *	◀▶	RTP/RTCP	UDP	Dynamically allocated ports used during VoIP calls for RTP and RTCP traffic. The port range can be adjusted through the System Gatekeeper tab.
50791	▶	IPO Voicemail	UDP	To voicemail server address.
50793	◀	IPO Solo Voicemail	UDP	From IP Office TAPI PC with Wave drive user support.
50794	◀	IPO Monitor	UDP	From the IP Office Monitor application.
50795	◀	IPO Voice Networking	UDP	Small Community Network signalling (AVRIP) and BLF updates. Each system does a broadcast every 30 seconds. BLF updates are sent required up a maximum of every 0.5 seconds.
50796	◀	IPO PCPartner	UDP	From an IP Office application (for example Phone Manager or SoftConsole). Used to initiate a session between the IP Office and the application.
50797	◀	IPO TAPI	UDP	From an IP Office TAPI user PC.
50798	▶	(UDP)	UDP	IP Office Manager and UpgradeWizard
50799	▶	IPO BLF	UDP	Broadcast to the IP Office LAN and the first 10 IP addresses registered from other subnets.
50800	▶	IPO License Dongle	UDP	To the License Server IP Address set in the IP Office configuration.
50801	◀	EConf	UDP	Conference Center Service to IP Office.
50802	◀	Discovery	TCP	IP Office discovery from Manager.
50804 *	◀	HTTP	TCP	IP Office configuration settings access.
50805 *	◀	HTTPS	TCP	TLS Secure "

Port		Protocol		Function
50808 *	◀	HTTP	TCP	IP Office system status access.
50812 *	◀	HTTP	TCP	IP Office security settings access.
50813 *	◀	HTTPS	TCP	TLS Secure "

- CDR/SMDR from the IP Office is sent to the port number and IP address defined during configuration and using either TCP or UDP as selected.

Ports

IP Office Monitor can be used to display IP packet details including the source and destination Port numbers. As well as displaying the port numbers (in decimal), IP Office Monitor also displays the names of more commonly used ports including IP Office specific ports.

For example "src = 23" is interpreted as "src = 23 (Telnet)".

The list below details the ports currently decoded by IP Office Monitor. For a full list of assigned non-IP Office ports see <http://www.iana.org/assignments/port-numbers>.

- 20 File Transfer [Default Data]
- 21 File Transfer [Control]
- 23 Telnet
- 25 Simple Mail Transfer
- 37 Time
- 43 Who Is
- 53 Domain Name Server
- 67 Bootstrap Protocol Server
- 68 Bootstrap Protocol Client
- 69 Trivial File Transfer
- 70 Gopher
- 79 Finger
- 80 World Wide Web-HTTP
- 115 Simple File Transfer Protocol
- 123 Network Time Protocol
- 137 NETBIOS Name Service
- 138 NETBIOS Datagram Service
- 139 NETBIOS Session Service
- 156 SQL Service
- 161 SNMP
- 162 SNMPTRAP
- 179 Border Gateway Protocol
- 1719 H.323Ras
- 1720 H.323/H.245
- 50791 IPO Voicemail
- 50792 IPO Network DTE
- 50793 IPO Solo Voicemail (i.e. Wave driver for TAPI)
- 50794 IPO Monitor
- 50795 IPO Voice Networking
- 50796 IPO PCPartner
- 50797 IPO TAPI
- 50798 IPO Who-Is response
- 50799 IPO BLF
- 50800 IPO License Dongle
- 50801 EConf

Protocols

IP Office Monitor, as well as displaying the Protocol number (in decimal) of packets, also displays the names of the more common Protocols. For example "pcol = 1" is decoded as "pcol = 1 (ICMP)".

Protocol numbers currently decoded by IP Office Monitor are:

- 1 - Internet Control Message [ICMP]
- 2 - Internet Group Management [IGMP]
- 6 - Transmission Control [TCP]
- 8 - Exterior Gateway Protocol [EGP]
- 9 - Interior Gateway Protocol [IGP]
- 17 - User Datagram [UDP]
- 41 - Ipv6 [IPV6]
- 46 - Reservation Protocol [RSVP]
- 47 - General Routing Encapsulation [GRE]
- 58 - ICMP for IPv6 [IPv6-ICMP]
- 111 - IPX in IP[IPX-In-IP]
- 115 - Layer Two Tunneling Protocol [L2TP]
- 121 - Simple Message Protocol [SMP]

11.10.18 Operating System Summary

The following table gives a summary of the operating systems on which the IP Office applications that are part of the IP Office 4.2 release have been tested and therefore are supported. While the applications may function of other operating systems, they will not have been tested by Avaya and so any faults reported will not be fixed.

Refer to the sections on the individual application for full details of operating system requirements and minimum PC requirements.

IP Office Application	Server			Client			
	2000	2003	2008	2000 Pro	XP Pro	Vista	
						Business/Enterprise	Ultimate
Call Status	X	✓	X	X	✓	✓	✓
Compact Business Center	X	✓	X	X	✓	✓	✓
Compact Contact Center: Server	✓	✓	X	X	X	X	X
": Wallboard Server	X	X	X	✓	✓	X	X
": Wallboard Client	X	X	X	✓	✓	X	X
": PC Wallboard	X	X	X	✓	✓	X	X
": Call Center View	X	X	X	✓	✓	X	X
": CCC Reporter	✓	✓	X	✓	✓	X	X
Conference Center	✓	✓	X	✓	X	X	X
ContactStore	✓	✓	X	✓	✓	X	X
Delta Server	X	✓	✓	X	✓	X	X
Feature Key Server	X	✓	X	X	✓	X	X
Manager	X	✓	✓	X	✓	✓	✓
Monitor	X	✓	✓	X	✓	✓	✓
MS-CRM: Server	✓	✓	X	X	✓	X	X
MS-CRM: Client	X	X	X	✓	✓	X	X
Phone Manager Lite	X	X	X	X	✓	✓	✓
Phone Manager Pro	X	X	X	X	✓	✓	✓
Phone Manager Pro PC Softphone	X	X	X	X	✓	✓	✓
SoftConsole	X	X	X	X	✓	✓	✓
System Status Application	X	✓	✓	X	✓	✓	✓
TAPI: (1st Party)	X	X	X	X	✓	✓	✓
": (3rd Party/WAV)	X	✓	X	X	✓	✓	✓
Voicemail Lite	X	✓	✓	X	✓	✓	✓
Voicemail Pro: Basic	X	✓	✓	X	✓	✓	✓
": plus IMS	X	✓	X	X	X	X	X
": plus UMS Web Voicemail and or Campaigns	X	✓	✓	X	X	X	X

1. Microsoft Windows 95, 98, ME, and NT4 operating systems have not been supported for IP Office applications for several releases. While the applications may function of these operating systems, they have not been tested with IP Office 4.2 and any faults reported will not be fixed.
2. The Vista operating systems Vista Home Basic and Vista Home Premium are not supported.
3. For IP Office 4.2, Windows 2000 operating systems are no longer supported.
4. Currently only 32-bit versions of operating systems are supported for IP Office applications.

Non OS Applications6	CCC V5 Reporter & Database	Conf. Center Client	Conference Center Database	Contact Store Database
Internet Explorer 6	Yes	Yes		
Internet Explorer 7		Yes		
Microsoft MSDE 2000	Yes		Yes	Yes

IP Office Applications Operating System/Service Pack Support Policy

When a new PC Operating System or Service Pack is released by Microsoft, Avaya will aim to support the new OS or Service Pack within 6 months of release. This time is required to re-certify the applications through the Software Verification and Field Trial programs. Support will then be announced in a Technical Tip or Bulletin.

11.11 Licence Keys

License shows the name as it appears in the IP Office configuration. RFA Name is the name used for the orderable item.

License	Description	RFA Name	SAP	
Advanced Small Community Networking	This license is used to enable remote hot desking, advertising hunt groups and distributed hunt groups within a Small Community Network. <ul style="list-style-type: none"> For remote hot desking a license is required on the system to which a user hot desks. For distributed and advertised hunt groups a license is required on each system. 	IPO LIC ADVANCED NTWKG	202966	
SIP Trunk Channels	These licenses are used to configure the maximum number of simultaneous SIP trunk calls supported.	IPO LIC SIP TRNK RFA	1	202967
			5	202968
			10	202969
			20	202970
DECT Integration (ports)	Enables enhanced DECT integration with the IP Office system. Used with Compact DECT and DECT DCU. Not used with Avaya IP DECT.	IP400 CTI DECT	8	171989
			16	174457
			24	174458
Conferencing Center	Enables the IP Office Conferencing Center application.	IP400 Conferencing Center	182302	
SoftConsole (users)	Adds one additional SoftConsole user. A maximum of four SoftConsole user can be licensed.	IP400 SoftConsole	171987	
Compact Business Center	Enables the CBC application for one user.	IP400 CBC	171993	
Small Office Edition WiFi	Enables use of the wireless card with the Small Office Edition control unit.	IP400 Access Point	182197	
Microsoft CRM Integration (users)	Allows operation between IP Office and MS-CRM server and clients.	IP400 Microsoft CRM Intgr	180588	
IPSec Tunneling	Enables the IP Office to initiate and terminate IPSec and L2TP tunnels.	IP400 IPSec VPN	182301	
Mobility Features	Enables the use of the IP Office 3.2+ mobile twinning features. <ul style="list-style-type: none"> For IP Office 4.2+, the Mobile Twinning license is now called the Mobility Features license, reflecting the fact that it can be used for Mobile Call Control and one-X Mobile Client support in addition to just mobile twinning. The mode of license operation has also changed. <ul style="list-style-type: none"> Prior to IP Office 4.2, the license was only consumed by users who had Mobile Twinning enabled. For IP Office 4.2 it is consumed by a user when they are configured for any of the mobility features, including mobile twinning even if they have turned mobile twinning off. For IP Office 4.2+, the license moves with hot desking users including within a Small Community Network. 	Mobile Twinning	1	195569
			5	195570
			10	195571
			20	195572
			50	195573
VPN IP Extensions	IP Office 4.1+. Used in conjunction with the Extension VoIP VPN Phone Allowed setting to license the operation of 46XX Series and 56XX Series phones using VPNremote firmware.	VPN Phone	1	213980
			5	213981
			10	213982
			25	213983
			50	213984
			100	213985
			Unlimited	213986
IP End-points	Controls the number of 3rd party H.323 devices supported by IP Office. No license is required for Avaya 4600 and 5600 series telephones. IP enabled Phone Manager Pro is licensed separately.	IP400 IP Endpoint	1	174956
			5	174957
			10	174958
			20	174959
			50	174960
			100	174961

11.11.1 IP500

Updated for the IP500 PRI channels license. Also the change for IP500 Voice Networking license.

License shows the name as it appears in the IP Office configuration. RFA Name is the name used for the orderable item.

License	Description	RFA Name	SAP
IP500 Upgrade Standard to Professional	Required to upgrade an IP500 from Standard Edition mode to Professional Edition mode.	IP500 IPO EXP UPG TO PRO	202959
IP500 Voice Networking	Used with the IP500 to enable support for SCN, QSIG and H323 IP trunks. A base license is required first to which additional licenses can then be added. <ul style="list-style-type: none"> For IP Office 4.0, this license is only supported in Professional Edition mode. For IP Office 4.1+ this license is supported in Standard Edition and Professional Edition modes. 	IP500 VOICE NTWKG BASE 4 LIC	4 202960
		IP500 VOICE NTWKG ADD LIC	- 205450
IP500 Universal PRI (Additional channels)	The IP500 PRI-U card supports E1, T1 and E1-R2 PRI modes. The IP Office system supports 8 unlicensed B-channels on each IP500 PRI-U port fitted. Additional B-channels, up to the capacity of ports installed and PRI mode selected require IP500 Universal PRI (Additional Channels) licenses added to the configuration. These additional channels consume the licenses based on which additional channels are configured as in-service from port 9 of slot 1 upwards. D-channels are not affected by licensing.	IP500 T1 Channels Add	2 21580
			8 21581
			32 21582
		IP500 E1 Channels Add	2 21583
			8 21584
			22 21585
		IP500 E1R2 Channels Add	2 21586
			8 21587
		22 21588	
IP500 VCM Channels	Used with IP500 VCM modules to enable additional channels. Each IP500 VCM base card supports 4 unlicensed channels with additional channels requiring licenses.	IP500 VCM LIC 4 CH	+4 202961
		IP500 VCM LIC 8 CH	+8 202962
		IP500 VCM LIC 16 CH	+16 202963
		IP500 VCM LIC 28 CH	+28 202964
		IP500 VCM LIC 60 CH	+60 202965

11.11.2 CCC

License shows the name as it appears in the IP Office configuration. RFA Name is the name used for the orderable item.

License	Description	RFA Name	SAP
CCC Server	Enables the CCC Server application (Archiver and Wallboard Manager) with support for 1 supervisor, reporting on 5 agents, and one PC Wallboard. <ul style="list-style-type: none"> This license is a pre-requisite for all the following CCC licensing. 	IP400 CCC SVR	171994
CCC Agents	Enables various numbers of additional agents (5, 10, 20, 50) for CCC reporting.	IP400 CCC AGT	5 171995
			10 174469
			20 174470
			50 174471
CCC Supervisors	Enables additional supervisors (1, 5, 10, 20) up to the maximum of 21 supported supervisors.	IP400 CCC SUP	1 171996
		" 5	5 184730
		" 10	10 184731
		" 20	20 184732
CCC PC Wallboards	Enables additional CCC PC Wallboards for 5, 10, 20, 50 agents.	IP400 CCC PCW	5 172786
		" 10	10 174472
		" 20	20 174473
		" 50	50 174474
CCC Spectrum Wallboards	Enables the operation of between 4 Spectrum wallboards (not Ferrograph). Licenses are cumulative up to a maximum of 16 wallboards.	IP400 CCC Wallboard	4 176196
Report Viewer	Allows additional users (5, 10, 20) access to historic reports.	IP400 CCC Report	5 184726
			10 184727
			20 184728
CCC Agent Rostering	Enables the Agent Rostering Interface for CCC which provides connection to a 3rd party Agent Rostering package (Blue Pumpkin). No longer supported.	IP400 CCC Rostering	171997
CCC Designer (users)	Enables CCC Report Designer, which permits a supervisor to design and customize their own reports. One license per user. Note: requires the user to have Crystal Report Writer software.	IP400 CCC Designer	171999
CTI Link Pro	Required for the CCC Email and CCC Chat licenses above.	IP400 CTI	171988*

11.11.3 CTI

License shows the name as it appears in the IP Office configuration. RFA Name is the name used for the orderable item.

License	Description	RFA Name	SAP
CTI Link Pro	Enables CTI Link Pro functionality (TAPI Link Pro and DEVLink Pro).	IP400 CTI	171988
Wave User	Allows streaming of WAV files, using TAPILink Pro, for 3rd party voice applications. This is a per user license. Note that TAPI WAV calls use system data channels taken from the same pools as used for voicemail ports. The maximum number of simultaneous TAPI WAV user calls and voicemail users is determined by the IP Office control unit type; Small Office Edition = 10, IP406 = 20, IP412 = 30, IP500 = 30.	IP400 TAPI WAV	177466

11.11.4 Phone Manager

License shows the name as it appears in the IP Office configuration. RFA Name is the name used for the orderable item.

License	Description	RFA Name	SAP	
Phone Manager Pro (per seat)	Enables Phone Manager Pro for 1, 5, 10, 20, 50, 100 or unlimited users. The user's Phone Manager mode is set through the IP Office configuration (User Telephony Phone Manager Type).	IP400 Phone Manager Pro	1	177468
			5	177469
			10	177470
			20	177471
			50	177472
Phone Manager Pro IP Audio Enabled (per user)	Enables Phone Manager Pro IP softphone operation for a user. Note: Also requires the user to have a Phone Manager Pro license.	IP400 IPPRO	1	171992
			5	174463
			10	174464
			20	174465
			50	174466

- In addition to entering Phone Manager licenses, each user is individually configured for the expected Phone Manager type.
- During operation, the number of Phone Manager license keys available and the number unused can be checked. Run Phone Manager and select Help | About. Holding down the Ctrl and Shift keys, click on the software version number.

11.11.5 VoiceMail

License shows the name as it appears in the IP Office configuration. RFA Name is the name used for the orderable item.

License	Description	RFA Name	SAP	
AUDIX Voicemail	Enables IP Office to use a remote Intuity Audix or Modular Messaging for voicemail. Does not require a local Voice Mail Pro server.	IP400 AUDIX	177467	
Voicemail Pro (4 ports)	Enables Voicemail Pro plus 4 ports.	IP400 Voicemail Pro	171991	
Additional Voicemail Pro (ports)	Adds additional ports (2, 4, 8 or 16) to an existing Voicemail Pro, up to the maximum number of ports supported by the IP Office control unit type. Maximum: Small Office Edition = 10, IP406 V2 = 20, IP412 = 30, IP500 = 30.	IP400 Voicemail Pro	2	174459
			4	174460
			8	174461
			16	174462
VMPro Networked Messaging	Enables VPNM (Voicemail Pro Networked Messaging) functionality within Voicemail Pro. This allows message exchange with remote Voicemail Pro systems and Avaya Interchange systems.	IP400 Networked Messaging	182297	
Integrated Messaging	Enables IMS Pro operation with Voicemail Pro. Enables synchronization to MS Exchange email systems with a form within Outlook to control voicemail playback.	IP400 Integrated Messaging Pro	171990	
VMPro TTS (Scansoft)	Enables use of text to speech facilities using Avaya supplied TTS software with Voicemail Pro. One license per simultaneous instance of TTS usage.	IP400 Avaya TTS	182299	
VMPro TTS (Generic)	Enables use of text to speech facilities using third party TTS software with Voicemail Pro. One license per simultaneous instance of TTS usage.	IP400 3rd Party TTS	182303	
VMPro VB Script	Enables VB Script functionality with Voicemail Pro.	IP400 VB Scripting	182300	
VMPro Database Interface	Enables 3rd party database support within Voicemail Pro call flows.	IP400 3rd Party IVR	182298	
VMPro Recordings Administrators	Enables integration between Voicemail Pro and the Avaya Contact Store for IP Office application. ContactStore can be run unlicensed from the date of the first recorded call.	IP400 ContactStore for IPO	187166	
UMS Web Services	Enables use of UMS Web Voicemail and IMAP for users to access their mailbox. Licensed UMS Web Services users who hot desk to a remote system remain licensed against their home IP Office system.	IPO LIC VMPRO UMS	1	217880
			5	217881
			10	217882
			20	217883
			50	217884

11.11.6 IP DECT

These licenses are for Avaya IP DECT. They differ from normal IP Office licenses in that they are entered into the Avaya IP DECT Mobility Manager (ADMM) base station of the IP DECT system and not into the configuration of the IP Office system. The licenses are based on the PARK number of the ADMM base station.

License	Description	RFA Name	SAP
1 Base Station	Allows a single base station (that being the ADMM).	IP DECT IPO MOBMGR 1 RFP LIC:CU	700379027
2 Base Stations	Allows up to 2 base stations.	IP DECT IPO MOBMGR 2 RFP LIC:CU	700379035
3-5 Base Stations	Allows up to 5 base stations.	IP DECT IPO MOBMGR 3-5 RFP LIC:CU	700379043
>5 Base Stations	Allows up to 32 base stations.	IP DECT IPO MOBMGR >5 RFP LIC:CU	700379050
Upgrade to 2	Upgrade to allow up to 2 base stations.	IP DECT IPO UPG TO A 2 BASE STATION LIC:CU	700379068
Upgrade to 3-5	Upgrade to allow up to 5 base stations.	IP DECT IPO UPG TO A 2 BASE STATION LIC:CU	700379076
Upgrade to >5	Upgrade to allow up to 32 base stations.	IP DECT IPO UPG TO A 2 BASE STATION LIC:CU	700379084

11.11.7 Trial Licenses

These licenses differ from other IP Office licenses in that they are time based and expire 60 days after issue. Each trial licenses will only be issued once for a particular Feature Key dongle serial number.

License	RFA Name	SAP
Voicemail Pro Networked Messaging	IPO TRIAL NTWKD MSGING LIC:DS	189776
3rd Party Database/IVR	IPO TRIAL 3RD PARTY IVR RFA LIC:DS	189777
Avaya Text-to-Speech for IP Office (1 port)	IPO TRIAL AVAYA TTS RFA 1 LIC:CU	189778
VB Scripting	IPO TRIAL VB SCRIPTING RFA LIC:DS	189779
Conferencing Center	IPO TRIAL CONF CENTER RFA LIC:DS	189780
Third Party Text to Speech (1 port)	IPO TRIAL 3RD PRTY TTS RFA LIC:CU	189781
Voicemail Pro (4 ports)	IPO TRIAL VM PRO RFA LIC:DS	189782
SoftConsole (1 user)	IPO TRIAL SOFTCONSOLE/BLF RFA LIC:CU	189783
Phone Manager PC Softphone (10 user)	IPO TRIAL IPPRO RFA 10 LIC:CU	189784
Phone Manager Pro (10 user)	IPO TRIAL PMGR PRO RFA 10 LIC:CU	189785
Centralized Voicemail with Avaya Messaging	IPO TRIAL ACM CENTRAL VM LIC:DS	189786
Mobility License (Mobile Twinning)	IPO LIC MOBILE TWINNING TRIAL RFA 5	195574
VPN IPSec	IPO TRIAL IPSEC VPN RFA LIC:DS	189788
IP500 Upgrade Standard to Professional	IPO LIC IP500 STD UPG TO PRO TRIAL	205822
VPN IP Phone	IPO LIC VPN PHONE 10 TRIAL	213987
UMS Web Services (10 users)	IPO TRIAL UMS 10 LIC:CU	217890

11.12 Ports

The following port types are found on IP Office systems:

Port	Found on	Description
ANALOG	ATM4 Trunk card (x4). Analog Trunk expansion module (x16).	Used for the connection of external analog trunks.
AUDIO	All IP Office control units (x1).	Used for input of an external music on hold source.
BRI	Quad BRI trunk card (x4). So8 expansion module (x8).	Used for connection of BRI trunks (Quad BRI trunk card) and ISDN terminals devices (So8 module).
DC I/P	All control units (x1). All expansion modules (x1).	Power input from external power supply unit.
DS	IP403 control unit (x8). IP406 V2 control unit (x8). Digital Station expansion modules (x16/x30).	Connection of Avaya digital station phones supported by IP Office .
RS232/ DTE	All control units (x1). All expansion modules (x1).	Used for control unit maintenance under Avaya guidance. On expansion modules not used.
EXPANSION	All control units (x various). All expansion modules except WAN3 (x1).	Used for interconnection of external expansions modules and control units.
EXT O/P	All control units (x1).	Used to control external relay systems. The port provides two switchable (on, off and pulse) controls.
	All modules (x1).	Used for connection of functional or protective ground if required.
LAN	All control units (x various).	10/100Mbps Ethernet LAN ports.
PF	Analog Trunk expansion module (x2).	Analog power fails ports.
PHONE (POT)	IP403 control unit (x2). IP406 V2 control unit (x2). Phones expansion modules (x8/x16/x30).	Analog phone extension ports. On older units these ports are labeled as POT ports.
PRI	Single PRI trunk cards (x1). Dual PRI trunk cards (x2).	PRI trunk ports.
USB	IP500 Control Unit (x1).	Not used.
WAN	All control units (x1). WAN3 expansion module (x3).	WAN interface ports. V.24, V.35 and X.21 through cable selection.
	Small Office Edition (x1)	RJ45 Ethernet port. Acts as Layer 3 ethernet switch to the modules LAN ports.

11.12.1 Cables

The IP Office systems are designed primarily for use within an RJ45 structured cabling system using CAT3 unshielded twisted-pair (UTP) cabling and RJ45 sockets.

A structured cabling system is one where cables are run from a central RJ45 patch panel in the communications/data room to individual RJ45 sockets at user's desk. All wires in each cable between the patch panel and the desk socket are connected straight through. This arrangement allows devices connected at the patch panel to be swapped to match the type of device that needs to be connected at the user socket. For example, making one user socket a phone port and another user socket a computer LAN port, without requiring any rewiring of the cables in between.

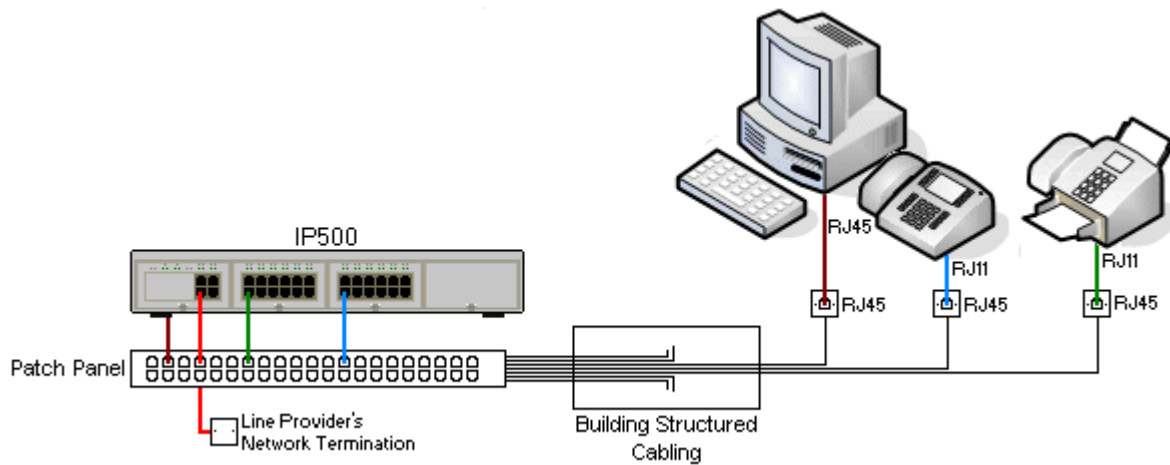

- **Traditional IDC Punchdown Wiring Installations**

Where necessary, the far end RJ45 plug can be stripped from IP Office cables and wired into traditional wiring systems using punch-block connectors. This type of installation should be performed by an experienced wiring technician.

- **Trunk Connections**

The majority of IP Office trunk ports use RJ45 connectors for acceptance of an RJ45-to-RJ45 cable. However, connection at the line providers end may require use of a different plug type in order to match the line providers equipment.

- **RJ11 Phone Connectors**

Many phones use RJ11 sockets and are supplied with RJ11-to-RJ11 cables. RJ11 plugs can be inserted into RJ45 sockets and in many case the connection will work. However this is not recommended or supported as the connection lock is not truly positive and may become disconnected. An [RJ45-to-RJ11 cable](#) is available for these connections.

Standard IP Office Cables

The following are Avaya standard cables available for use with IP Office systems. The maximum length is applicable if the standard Avaya cable is replaced with an alternate cable.

Cable	Description	SAP Code	Standard Length	Maximum Length
9-Way DTE Cable	Connects to control unit RS232 DTE port. 9-Way D-type plug to 9-way D-type socket.	-	2m/6'6"	2m/6'6"
Structured Cabling DS Line Cable	Connects from RJ45 sockets to RJ11 socketed DS and analog phones.	700047871	4m/13'2"	See table below.
BRI/PRI Trunk Cable	Connects BRI/PRI trunk ports to the line providers network termination point. RJ45 to RJ45. Red.	700213440	3m/9'10"	-
Expansion Interconnect Cable	Connects the control unit to expansion modules (except WAN3 modules). RJ45 to RJ45. Blue.	700213457	1m/3'3"	1m/3'3"
LAN Cable	Connects from IP Office LAN ports to IP devices. RJ45 to RJ45. Grey.	700213481	3m/9'10"	100m/328'
LAN Interconnect Cable	Connects WAN3 module to the control unit. Replace with a LAN crossover cable for IP412 control units. Green.	700213465	1m/3'3"	-
LAN Crossover Cable	Used for connection of IP devices to LAN ports on the IP412 control unit. Black	700213473	3m/9'10"	100m/328'
V.24 WAN Cable	37-Way D-type plug to 25-way D-type plug.	700213416	3m/9'10"	5m/16'5"
V.35 WAN Cable	37-Way D-type plug to 34-way MRAC plug.	700213424	3m/9'10"	5m/16'5"
X.21 WAN Cable	37-Way D-type plug to 15-way D-type plug.	700213408	3m/9'10"	5m/16'5"

The table below details the maximum total cable distances for DS and analog extensions using different cable types.

Telephone	Unshielded Twisted-Pair (UTP) - 50nf/Km			CW1308
	AWG22 (0.65mm)	AWG24 (0.5mm)	AWG26 (0.4mm)	
2400/5400 Series	1200m/3937'	1000m/3280'	670m/2200'	400m/1310'
4406D Phone	1000m/3280'	1000m/3280'	400m/1310'	400m/1310'
4412D Phone	1000m/3280'	700m/2295'	400m/1310'	400m/1310'
4424D	500m/1640'	500m/1640'	400m/1310'	400m/1310'
6400 Series	1000m/3280'	1000m/3280'	400m/1310'	400m/1310'
T3 Series (Upn)	1000m/3280'	1000m/3280'	400m/1310'	-
Analog Phones	1000m/3280'	1000m/ 3280'	400m/1640'	800m/2620'

11.12.2 ANALOG Port

These ports are analog trunk ports. The IP400 ATM4 analog trunk cards and IP500 analog trunk cards only support loop-start trunks. The ATM16 Analog Trunk module supports both loop-start and ground-start trunks, switchable within the IP Office configuration.

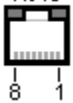
ANALOG	Pin	Description
RJ45 	1	Not used.
	2	Not used.
	3	Not used.
	4	Ring.
	5	Tip.
	6	Not used.
	7	Not used.
	8	Not used.

- Off-Hook Current: 25mA.
- **⚠ IMPORTANT**
In all IP Office installations, any module being used for analog trunk connections must be connected to a [functional earth](#).
- **⚠ WARNING**
Within the Republic of South Africa and in areas of high lightning risk, any module using analog trunk connections must be connected to a [protective ground](#) and to [surge protection equipment](#).

11.12.3 AUDIO Port

This port is found on the rear of all IP Office control units. It is used for the input of an external music-on-hold sound source. Note that if the IP Office has loaded an internal music-on-hold sound file, any input from this socket is ignored.

The port is a 3.5mm stereo jack socket suitable for use with the most standard audio leads and connection to the 'headphone' output socket of most audio systems.

The use of a 'headphone' socket allows simple volume adjustment. Connection via a 'Line Out' socket may require additional equipment in order to adjust the volume level.

Pin No.	Description
Common	● Common
Left	◀ Audio In - Left Channel.
Right	◀ Audio In - Right - Channel.

- Input impedance: 10k /channel. Maximum a.c. signal – 200mV rms.

11.12.4 BRI Port (So)

The BRI ports found on the front of the So8 module are BRI So interface ports for connect to ISDN terminal devices.

For IP Office 4.2+, IP500 BRI trunk daughter cards can be switched from To to So mode. IP400 BRI trunk cards can only be used as [To connections](#).

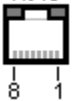
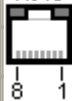
IP Office			Wire	ISDN Terminal	
BRI	RJ45	BRI		PIN	RJ45
	1	-	White/Orange	1	
	2	-	Orange/White	2	
	3	← Rx-A	White/Green	3	
	4	→ Tx-B	Blue/White	4	
	5	→ Tx-A	White/Blue	5	
	6	← Rx-B	Green/White	6	
	7	-	White/Brown	7	
	8	-	Brown/White	8	

• Terminating Resistors

100ohm Terminating resistors are required across the transmit and receive wire pairs at each end of the S-bus.

- The IP Office So8 module BRI ports include integral 100ohm terminating resistors.
- For IP Office 4.2+, individual ports of an IP500 BRI daughter card can be switched to So mode. This is done by setting the **Line Sub-Type** to **S-Bus** in the IP Office configuration. In this case terminating resistors must be added at the IP Office end in addition to those at the other end of the S-bus connection.
 - Addition of the necessary termination at the IP Office end can be done using an IP500 BRI So Converter Cable (700458649). This short (25cm/10") cable includes both the necessary terminating resistors and the cable cross-over.
- Many ISDN terminal devices includes terminating resistors. If this is not the case, 100ohm (+/-5%) resistors must be connected across the receive wire pair and the transmit wire pair in the junction box immediately before the last ISDN terminal on the S-bus.



11.12.5 BRI Port (To)

These ports are BRI To interface ports for connection to external BRI trunk services. Note that BRI ports found on the IP400 So8 module are BRI-S interface ports for connect to ISDN terminal devices, see [BRI Port \(So\)](#).

PRI/BRI Trunk Cable

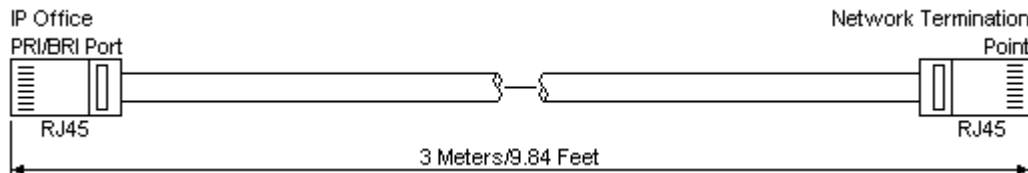
This cable is used to connect from IP Office BRI/PRI trunk ports to the line providers network termination equipment. If that equipment does not use RJ45 sockets, the cable may need to be stripped and rewired or an alternate cable used. The appropriate signal pin-outs and wire colours are detailed below.



IP Office				Wire	Network Termination	
BRI	RJ45	BRI	PRI		PIN	RJ45
 8 1	1	-	← Rx-A	White/Orange	1	 8 1
	2	-	← Rx-B	Orange/White	2	
	3	→ Tx-A	-	White/Green	3	
	4	← Rx-A	→ Tx-A	Blue/White	4	
	5	← Rx-B	→ Tx-B	White/Blue	5	
	6	→ Tx-B	-	Green/White	6	
	7	-	-	White/Brown	7	
	8	-	-	Brown/White	8	

- Supply: BRI/PRI trunks cards are not supplied with these cables.
- Cable Color: Red.
- SAP Code: 700213440.
- Standard Length: 3m/9'10".
- Maximum Length: 5m/16'5".
- Though not used pins 7 and 8 are through connected for ease of construction.

11.12.6 DC I/P Port

Found on all IP Office control units and expansion modules. Used for connection from the external [power supply unit](#) supplied with the control unit or module.

- No other type of power supply unit should be used with the module or module unless specifically indicated by Avaya.
- Power cords must not be attached to the building surface or run through walls, ceilings, floors and similar openings.

11.12.7 DS Ports

These ports are used for connection from an RJ45 structured cabling system to digital station phones supported by the IP Office.

Though the RJ11 to RJ11 cables supplied with most DS phones can be plugged directly into RJ45 ports including those on IP Office modules, this is not recommend as the connection lock is not positive and may become disconnected.

DS ports on Digital Station V1/V2 expansion modules can be connected to [out-of-building extensions](#). If this is the case, connection must be made via suitable protective devices at each end and via each building primary protection. In addition the Digital Station module must be connected to a protective ground.



DS ports on IP Office control units must not be connected to out-of-building extensions.

Structured Cabling Line Cord

This is an RJ45 to RJ11 cable suitable for connection from a structured cabling system RJ45 port to a DS phone. It can also be used for two-wire analog phone extensions.

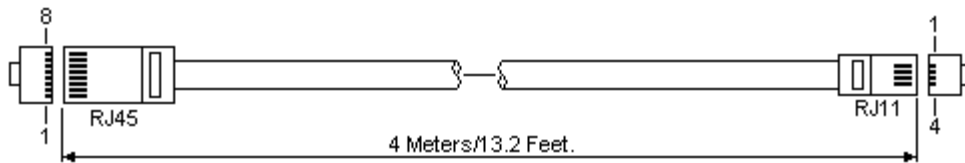
This cable is not suitable for connection from an Avaya 1151D1/B2 power supply unit to a DS phone with a 4450, EU24 or XM24 add-on module. In those cases the cables supplied with the power supply unit and the add-on module should be used.



IP Office			Phone	
DS Port	Pin	Description	Pin	Port
RJ45  8 1	1	Not used.	-	RJ11  6 1
	2	Not used.	1	
	3	Not used.	2	
	4	Signal 1.	3	
	5	Signal 2.	4	
	6	Not used.	5	
	7	Not used.	6	
	8	Not used.	-	

- SAP Code: 700047871.

11.12.8 RS232 DTE Port

These ports are found on the rear of all IP Office control units and external expansion modules. The DTE ports on external expansion modules are not used.

The RS232 DTE ports on the control units can be used for system maintenance and connection of serial terminal adaptors. On IP400 control units the port can also be used for connection of the IP Office serial port licence key dongle.

An asynchronous terminal program such as HyperTerminal is also required. Configure this for operation via a PC serial port, as follows:

Bits per second	38,400	Parity	None	Flow Control	None
Data bits	8	Stop Bits	1	Settings Emulation	TTY

DTE Cables

These cables are used for system maintenance and diagnostics under Avaya guidance. They can also be used for connection of RS232 serial terminal adaptor equipment to the IP Office control unit.

The cable required depends on the IP Office control unit. This cable is a "Straight through DB9 female to DB9 male serial cable".

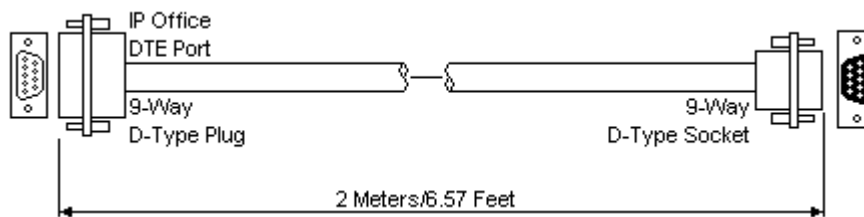

IP Office 9-Way RS232 DTE Port	Signal	PC/Terminal Adaptor
3	← Receive data	3
2	→ Transmit Data	2
7	← RTS (Request To Send)	7
8	→ CTS (Clear To Send)	8
6	→ DSR (Data Set Ready)	6
5	● Ground	5
1	→ DCD (Data Carrier Detect)	1
4	← DTR (Data Terminal Ready)	4
9	→ RI (Ring Indicator)	9

11.12.9 EXPANSION Port

This type of port is found on the rear of IP Office control units and external expansion modules. It is used for connecting the external expansion modules to their parent IP Office control unit.

The connection between these ports should only be done using an Avaya Expansion Interconnect Cable. No other cable type should be used.

Expansion Interconnect Cable

The Expansion Interconnect cable is used to link expansion ports between the IP Office control unit and external expansion module (except WAN3 modules).

- **WARNING:** This is the only cable that should be used for connecting an IP Office control unit to external expansion modules (except for WAN3 modules).

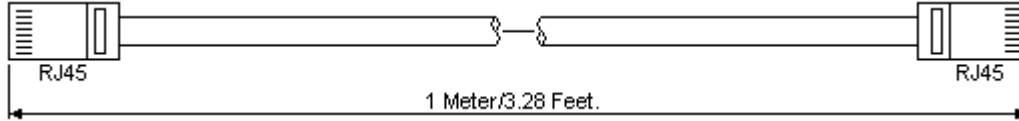

- Supply: One cable is normally supplied with each external expansion module.
- SAP Code: 700213457

11.12.10 EXT O/P Port

These ports are found on the rear of all IP Office control units. They are used for connection to external switching relays. The port uses a standard 3.5mm stereo jack plug for connection.

The IP Office is able to open (high resistance), close (low resistance) or pulse (close for 5 seconds and then open) two switches within the port. Either switch can be operated separately. These switches are intended for activation of external relays in systems such as door opening systems.

- **CAUTION:** In installations where this port is connected to a device external to the building, connection must be via a towerMAX SCL/8 Surge Protector and a protective ground connection must be provided on the IP Office control unit.

EXT O/P	Pin	Description
	1	Switch 1.
	2	Switch 2.
	3	0 Volts (Ground/Chassis)

- Switching Capacity: 0.7A.
- Maximum Voltage: 55V d.c.
- On state resistance: 0.7 ohms.
- Short circuit current: 1A.
- Reverse circuit current capacity: 1.4A.
- Ensure that pins 1 and 2 are always at a positive voltage with respect to pin 3.

3.5mm stereo audio jack plugs are frequently sold as pre-wired sealed modules. It may be necessary to use a multi-meter to determine the wiring connections from an available plug. Typically 3 (common to both relays) is the cable screen.

11.12.11 LAN Port

These ports are found on IP Office control units and the WAN3 10/100 expansion module. They are used for connection to IP LAN's and IP devices. On the WAN3 10/100 module the port is used for direct connection to a control unit.

All IP Office LAN ports are 10/100Mbps auto-sensing. Operation varies as follows:

- **IP Office 500**

This unit has 2 RJ45 Ethernet ports, marked as LAN and WAN. These form a full-duplex managed layer-3 switch. Within the IP Office configuration, the physical LAN port is LAN1, the physical WAN port is LAN2.

- **IP460 V2**

This unit has 8 RJ45 Ethernet ports marked as LAN 1 to 8. These form a full-duplex unmanaged layer-2 LAN switch. Ports are auto-MDI/MDIX. Within the IP Office configuration the physical LAN ports are LAN1.

- **IP412**

This unit has 2 RJ45 Ethernet ports marked as LAN 1 to 2. These form a half-duplex managed layer-3 switch. Both ports are fixed MDI crossover ports. Within the IP Office configuration, physical port 1 is LAN1, physical port 2 is LAN2.

- **Small Office Edition**

This unit has 4 RJ45 Ethernet ports marked LAN 1 to 4. These form a full-duplex unmanaged layer-2 switch. An addition RJ45 Ethernet socket marked as WAN exists. With the LAN ports this acts as a managed layer-3 switch. Within the IP Office configuration, the physical LAN ports are LAN1, the physical WAN port is LAN2.



The LAN port LED's are used as follows:

- Green: On = connected, Flashing = Activity.
- Yellow: On = 100Mbps, Off = 10Mbps.

LAN Cables

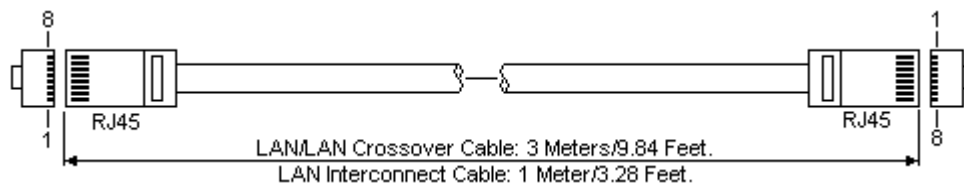
These are CAT5 UTP cables for connection of various IP devices within the IP Office system.

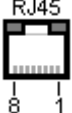

IP Office							
LAN	Pin	MDIX (Normal)	MDI (Crossover)	Wire	Standard/ Interconnect	Crossover	
	1	← Rx-A.	→ Tx-A.	White/Orange	1	3	
	2	← Rx-B.	→ Tx-B.	Orange/White	2	6	
	3	→ Tx-A.	← Rx-A.	White/Green	3	1	
	4	Not used.	Not used.	Blue/White	4	4	
	5	Not used.	Not used.	White/Blue	5	5	
	6	→ Tx-B.	← Rx-B.	Green/White	6	2	
	7	Not used.	Not used.	White/Brown	7	7	
	8	Not used.	Not used.	Brown/White	8	8	

- **SAP Code:**

- **LAN Cable - GREY: 700213481.**

Standard straight LAN cable.

- **LAN Interconnect Cable - Green: 700213465.**

Supplied with WAN3 modules for the direct connection of the WAN3 module to an IP Office control unit LAN port. For an IP412 control unit, this cable should be replaced with a LAN crossover cable.

- **LAN Crossover Cable - Black: 700213473.**

LAN crossover cable.

11.12.12 PF Port

These ports are analog extension ports that can be used in conjunction with analog loop-start trunks during power failure to the IP Office system. They are found on the rear of the IP400 Analog Trunk expansion module.

There are a number of options to connect analog extension ports to analog trunks during power failure. In all cases these only work with loop-start analog trunks. Any phones connected to these ports should be clearly labeled as power fail extensions in accordance with the appropriate national and local regulatory requirements.

- **IP400 Small Office Edition**

On the Small Office Edition control unit, ANALOG port 2 is connected to PHONE (POT) port 1 during power failure.

- **IP400 ATM16 External Expansion Module**

During power fail conditions, PF1 is internally connected to ANALOG port 1 on the module, PF2 is internally connected to ANALOG port 2 on the same module.

- **IP500 Office**

When an IP500 Analog Phone 8 base card is fitted with an IP500 Analog Trunk daughter card, during power failure extension port 8 is connected to analog trunk port 12.

Any phones connected to these ports should be clearly labelled as power fail extensions in accordance with the appropriate national and local regulatory requirements.

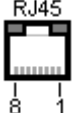
PF	Pin	Description
 RJ45 8 1	1	Not used.
	2	Pin 2 is internally connected to pin 5 via a ringer capacitor.
	3	Not used.
	4	Ring.
	5	Tip.
	6	Pin 6 is internally connected to pin 5 via a ringer capacitor.
	7	Not used.
	8	Not used.

- Minimum Wire Size: AWG 26.
- Maximum Cable Length:
 - AWG26: 500m / 1640'.
 - AWG24, AWG22: 1000m / 3280'.

11.12.13 PHONE (POT) Port

These ports are analog extension ports. On older IP Office units these ports were labeled as POT ports rather than PHONE ports.

PHONE ports on Phone V1/V2 expansion modules can be connected to [out-of-building extensions](#). If this is the case, connection must be made via suitable protective devices (IP Office Barrier Box) at each end and via each building primary protection. In addition the Phone module must be connected to a protective ground.

PHONE ports on IP Office control units must not be connected to out-of-building extensions.

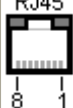
PHONE	Pin	Description
	1	Not used.
	2	Not used.
	3	Not used.
	4	Ring.
	5	Tip.
	6	Not used.
	7	Not used.
	8	Not used.

- REN: 2
- Off-Hook Current: 25mA.
- Ring Voltage: 40V rms.
- Minimum Wire Size: AWG 26.
- Maximum Cable Length:
 - AWG26: 0.5km / 1640 feet.
 - AWG24, AWG22: 1km / 3280 feet.

Except on some older equipment, these ports do not include a ringing capacitor. Therefore for connection to 4-wire analog phones where this is a requirement (typically the United Kingdom and New Zealand), connection should be via a Master socket containing ringing capacitors. On some older Small Office Edition, IP403 and IP400 Phone V1 modules, pins 2 and 6 are internally connected via ringing capacitors.

Structured Cabling Line Cord

This is an RJ45 to RJ11 cable suitable for connection from a structured cabling system RJ45 port to a DS phone. It can also be used for two-wire analog phone extensions.

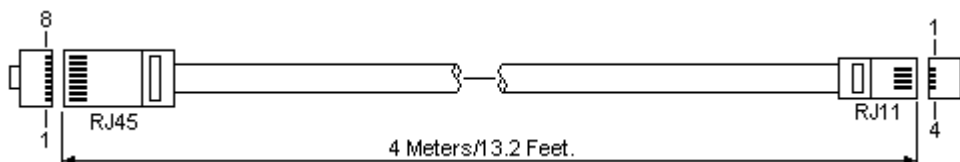

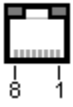
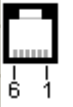
IP Office		Phone		
DS Port	Pin	Description	Pin	Port
	1	Not used.	–	
	2	Not used.	1	
	3	Not used.	2	
	4	Signal 1.	3	
	5	Signal 2.	4	
	6	Not used.	5	
	7	Not used.	6	
	8	Not used.	–	

- SAP Code: 700047871.

11.12.14 PRI Port

These ports are used for connection to PRI trunk services including E1, T1 and E1-R2.

PRI/BRI Trunk Cable

This cable is used to connect from IP Office BRI/PRI trunk ports to the line providers network termination equipment. If that equipment does not use RJ45 sockets, the cable may need to be stripped and rewired or an alternate cable used. The appropriate signal pin-outs and wire colours are detailed below.

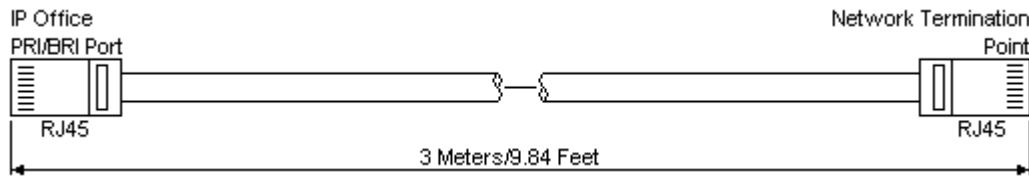

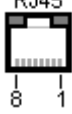
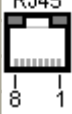
IP Office				Wire	Network Termination	
BRI	RJ45	BRI	PRI		PIN	RJ45
 8 1	1	-	← Rx-A	White/Orange	1	 8 1
	2	-	← Rx-B	Orange/White	2	
	3	→ Tx-A	-	White/Green	3	
	4	← Rx-A	→ Tx-A	Blue/White	4	
	5	← Rx-B	→ Tx-B	White/Blue	5	
	6	→ Tx-B	-	Green/White	6	
	7	-	-	White/Brown	7	
	8	-	-	Brown/White	8	

- Supply: BRI/PRI trunks cards are not supplied with these cables.
- Cable Color: Red.
- SAP Code: 700213440.
- Standard Length: 3m/9'10".

11.12.15 WAN Port

This type of port 37-way D-type port is found on the rear of IP406 V2 and IP412 control units, and on the rear of the WAN3 10/100 external expansion modules. For the Small Office Edition control unit an optional WAN trunk interface card can be fitted.

Each WAN port supports a single synchronous data connection, which can be X.21, V.35 or V.24/V.28. Selection of the required interface is determined by the cable plugged into the WAN port when power is applied.

- WAN ports must be clocked externally, the IP Office does not provide a clock signal. The clock signal is usually provided by the service provider but under some circumstances (for example laser, microwave or baseband modems) extra provision must be made by the installer.

Pin	Protocol	Description	Pin	Protocol	Description
1	X.21	←Rx-B: Receive Data B.	20	X.21	←Rx-A: Receive Data A.
2	X.21	←Ind-A: Indicate A.	21	X.21	←Ind-B: Indicate B.
3	X.21	←Clk-A: Clock A.	22	X.21	←Clk-B: Clock B.
4	X.21	→Tx-A: Transmit Data A.	23	X.21	→Tx-B: Transmit Data B.
5	X.21	→Ctl-B: Control B.	24	X.21	→Ctl-A: Control A.
6	X.21	■ Ground	25	V.35	←WAN ID 0: Connect to Pin 6.
7	X.21	←WAN ID 1: Connect to Pin 6.	26	V.24	→Tx: Transmit Data.
8	V.24/V.35	→DTR: Data Terminal Ready.	27	V.24/V.35	→RTS: Request to Send.
9	V.24	←Rx: Receive Data.	28	V.24	←RxClk: Receive Clock.
10	V.24	←TxClk: Transmit Clock.	29	V.24/V.35	←RI: Ring Indicator.
11	V.24/V.35	←DCD: Data Carrier Detect.	30	V.24/V.35	←DSR: Data Set Ready.
12	V.24/V.35	←CTS: Clear to Send.	31	-	Not used.
13	-	Not used.	32	V.35	→Tx-A: Transmit Data A.
14	V.35	→Tx-B: Transmit Data B.	33	V.35	→SCTE-A: External Clock A.
15	V.35	→SCTE-B: External Clock B.	34	V.35	■ V35 Gnd
16	V.35	→Rx-B: Receive Data B.	35	V.35	→Rx-A: Receive Data A.
17	V.35	←TxClk-B: Transmit Clock B.	36	V.35	←TxClk-A: Transmit Clock A.
18	V.35	←RxClk-B: Receive Clock B.	37	V.35	←RxClk-A: Receive Clock A.
19	V.24	■ CHASSIS	-	-	-

1. For the USA, only FCC Part 68 registered data circuit terminal equipment should be connected to the WAN Ports.
2. In all cases Pin 19 should be connected to the cable screen.

11.12.16 V.24 WAN Cable

This cable is used for connection an IP Office 37-way D-type WAN port to the V.24 WAN service providers equipment.

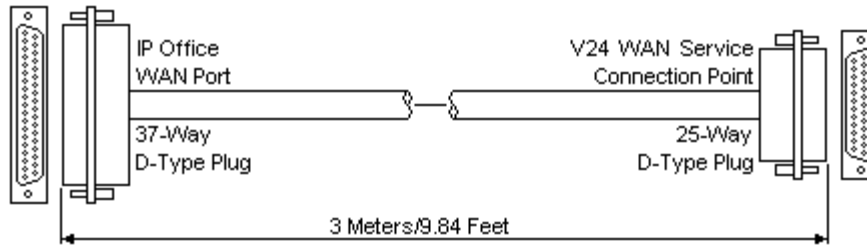

IP Office WAN Port	Signal	V.24 WAN Service
6	■ Ground	7
8	➔ DTR: Data Terminal Ready.	20
9	➔ Rx: Receive Data	3
10	➔ Tx: Transmit Clock	15
11	➔ DCD: Data Carrier Detect.	8
12	➔ CTS: Clear To Send.	5
26	➔ Tx: Transmit Data.	2
27	➔ RTS: Request To Send.	4
28	➔ Rx-Clk: Receive Clock.	17
29	➔ RI: Ring Indicator.	22
30	➔ DSR: Data Set Ready.	6
<ul style="list-style-type: none"> • At the IP Office end pin 25 is connected to pin 6. • At the IP Office end pin 19 is connected to the Screened Cable Drain Wire. 		

- Supply: This cable is not supplied with the control unit or WAN3 module. It must be ordered separately.
- SAP Code: 700213416
- Cable: 12-core screened cable. Each core is 7/0.203mm (24 AWG) tinned copper stranded wire, nominal capacitance of 95pF/m, resistance of 92 ohms/km, screened with tinned copper braid, maximum working voltage of 440V rms and a maximum current per core of 1A rms. The maximum core to core capacitance must not exceed 800pF.
- Maximum Length: 5m/16'5". This is the maximum length that should be used if the above cable is replaced with an alternate cable.

11.12.17 V.35 WAN Cable

This cable is used for connection an IP Office 37-way D-type WAN port to the V.35 WAN service providers equipment.

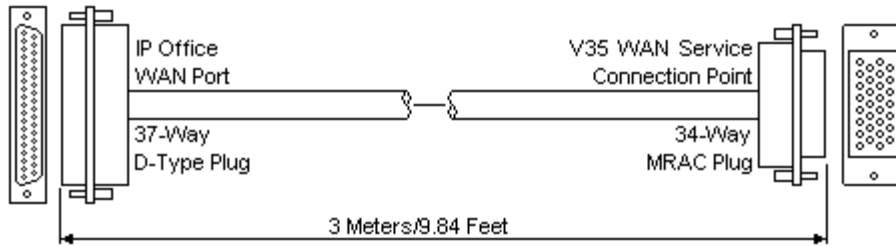

IP Office WAN Port	Signal	Wire	V.35 WAN Service
8	→ DTR: Data Terminal Ready.	-----	H
11	← DCD: Data Carrier Detect.	-----	F
12	← CTS: Clear To Send.	-----	D
27	→ RTS: Request To Send.	-----	C
29	← RI: Ring Indicator.	-----	J
30	← DSR: Data Set Ready.	-----	E
32	→ Tx-A: Transmit Data A.	Twisted Pair	P
14	→ Tx-B: Transmit Data B.		S
35	← Rx-A: Receive Data A.	Twisted Pair	R
16	← Rx-B: Receive Data B.		T
36	→ TxClk-A: Transmit Clock A.	Twisted Pair	Y
17	→ TxClk-B: Transmit Clock B.		AA
37	← RxClk-A: Receive Clock A.	Twisted Pair	V
18	← RxClk-B: Receive Clock B.		X
33	→ SCTE-A: External Clock A.	Twisted Pair	U
15	→ SCTE-B: External Clock B.		W
34	■ Ground	-	B

- At the IP Office end pins 7 and 25 are connected to pin 6.
- At the IP Office end pin 19 is connected to the Screened Cable Drain Wire.

- Supply: This cable is not supplied with the control unit or WAN3 module. It must be ordered separately.
- SAP Code: 700213424.
- Cable: 10 twisted pair screened cable - each core is 7/0.203mm (24 AWG) tinned copper stranded wire, nominal capacitance of 98pF/m, impedance of 80 10% at 1MHz, screened with aluminized tape and a tinned copper wire drain. The maximum core to core capacitance must not exceed 800pF.
- Maximum Length: 5m/16'5". This is the maximum length that should be used if the above cable is replaced with an alternate cable.

11.12.18 X.21 WAN Cable

This cable is used for connection from an IP Office 37-way D-type WAN port to the X.21 service providers equipment.

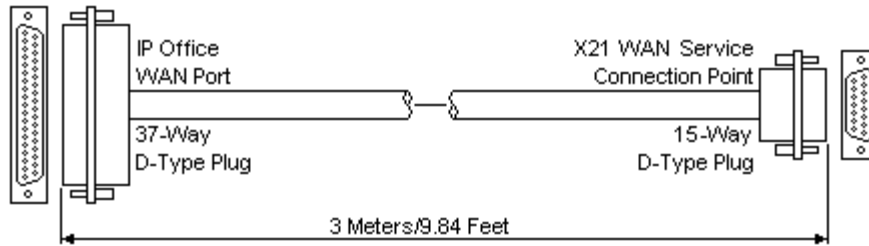

IP Office WAN Port	Signal	Wires	X.21 WAN Service
1	← Rx-B: Receive B.	Twisted Pair	11
20	← Rx-A: Receive A.		4
4	→ Tx-A: Transmit A.	Twisted Pair	2
23	→ Tx-B: transmit B.		9
24	→ Ctl-A: Control A.	Twisted Pair	3
5	→ Ctl-B: Control B.		10
2	← Ind-A: Indicate A.	Twisted Pair	5
21	← Ind-B: Indicate B.		12
3	← Clk-A: Clock A.	Twisted Pair	6
22	← Clk-B: Clock B.		13
6	■ Ground	-----	8

- At the IP Office end pin 7 is connected to pin 6.
- At the IP Office end pin 19 is connected to the Screened Cable Drain Wire.

- Supply: This cable is not supplied with the control unit or WAN3 module. It must be ordered separately.
- SAP Code: 700213408.
- Cable: 6 twisted pair screened cable - each core is 7/0.203mm (24 AWG) tinned copper stranded wire, nominal capacitance of 98pF/m, impedance of 77ohms at 1MHz, screened with aluminized tape and a tinned copper wire drain.
- Maximum Length: 5m/16'5". This is the maximum length that should be used if the above cable is replaced with an alternate cable.

11.13 SAP Codes

Update with IP500 PRI-U trunk daughter card details. Also update the IP Office 4.1 CD/DVD codes and Voicemail Pro 4.1 CD code.

IP Office Control Units

Variant	Companding	Country	SAP Code
IP500 Office.	-	All	700417207
IP412 Office.	A-Law	Rest of World	700234479
	U-Law	North America	700350408
IP406 V2 Office DS.	A-Law	Rest of World	700343536
	U-Law	North America	700359946
Small Office Edition 4T+4A+8DS (3 VoIP)	A-Law	Rest of World	700280209
	U-Law	North America	700350424
Small Office Edition 4T+4A+8DS (16 VoIP)	A-Law	Rest of World	700280217
	U-Law	North America	700350432

- IP400 and Small Office Edition control units are supplied with an external power supply unit but not a locale specific power cord. All control units are available in either North America or Rest of World variants. The choice controls various default settings of the unit. For E911 support a North American variant control unit must be used. The companding can be changed once a unit is installed.
- IP500 control units have an integral power supply unit but are not supplied with a locale specific power cord. The appropriate Mu-Law or A-Law Smart Card feature key dongle must be order with the control unit.

IP500 Base Cards

IP500 Base Cards			Country	SAP Code
Digital Extension	IPO 500 Extn Card Dgtl Sta 8	IP Office 500 Extension Card Digital Station 8	All	700417330
Analog Extension	IPO 500 Extn Card Phone 2	IP Office 500 Extension Card Phone 2	All	700431778
	IPO 500 Extn Card Phone 8	IP Office 500 Extension Card Phone 8	All	700417231
VCM	IPO 500 MC VCM 32	IP Office 500 Media Card Voice Coding Module 32	All	700417389
	IPO 500 MC VCM 64	IP Office 500 Media Card Voice Coding Module 64	All	700417397
Carrier Card	IPO 500 Carrier Card	IP Office 500 Carrier Card	All	700417215

IP500 Trunk Daughter Cards

Variant		Country	SAP Code
Analog	IPO 500 Trnk Anlg 4 Uni	IP Office 500 Trunk Card Analog 4 Universal	All 700417405
PRI	IPO 500 Trnk PRI 1 Uni	IP Office 500 Trunk Card Primary Rate 1 Universal	All 700417439
	IPO 500 Trnk PRI 2 Uni	IP Office 500 Trunk Card Primary Rate 2 Universal	All 700417462
BRI	IPO 500 Trnk BRI 4 Uni	IP Office 500 Trunk Card Basic Rate 4 Universal	All 700417413
	IPO 500 Trnk BRI 8 Uni	IP Office 500 Trunk Card Basic Rate 8 Universal	All 700417421

IP400 Trunks Cards

Variants		Country	SAP Code	SOE	IP406 V2	IP412	IP500
Analog	ATM4 Uni (Loop-Start)	All	700359938	✗	✓	✓	✓
	IP400 Analog 4 (Loop-Start)	North and South America	700185192	✗	✓	✓	✗
	IP400 Analog 4 EU (Loop-Start)	Europe	700241672	✗	✓	✓	✗
	IP400 Analog 4 NZ (Loop-Start)	New Zealand	700241706	✗	✓	✓	✗
BRI	IP400 BRI 8 (UNI)	All except China	700262017	✓	✓	✓	✓
	IP400 BRI	All	700185168	✓	✓	✓	✗
T1/PRI	IP400 PRI 24 T1	North America	700185200	✓	✓	✓	✓
	IP400 PRI 48 T1	North America	700185218	✗	✓	✓	✓
E1 PRI	IP400 PRI 30 E1 (1.4)	All except China and CALA.	700272461	✗	✓	✓	✓
	IP400 PRI 60 E1	All except China and CALA.	700185184	✗	✓	✓	✓
E1R2	IP400 PRI 30 E1R2 RJ45	CALA, Korea, China	700241631	✗	✓	✓	✓
	IP400 PRI 60 E1R2 RJ45	CALA, Korea, China	700241649	✗	✓	✓	✓
	IP400 PRI 30 E1R2 COAX	CALA	700241656	✗	✓	✓	✗
	IP400 PRI 60 E1R2 COAX	CALA	700241664	✗	✓	✓	✗
WAN	IP400 WAN Expansion	All	700289713	✓	✗	✗	✗

IP500 External Expansion Modules

Expansion modules include an external power supply unit (PSU) and an appropriate interconnect cable. They do not include a locale specific power cord for the external PSU or any phone extension cables.

Variant		Country	SAP Code
Analog Trunk	IPO 500 Analog Trunk 16	US	700449473
BRI So8	IPO 500 BRI So8	All	700449515
Digital Station	IPO 500 Digital Station 16	All	700449499
	IPO 500 Digital Station 30	All	700426216
Analog Phone	IPO 500 Phone 16	All	700449507
	IPO 500 Phone 30	All	700426224

IP400 External Expansion Modules

Expansion modules include an external power supply unit (PSU) and an appropriate interconnect cable. They do not include a locale specific power cord for the external PSU or any phone extension cables.

Variant		Country	SAP Code
Analog Trunk	IP400 Analog Trunk 16	North America/CALA	700211360
		Europe	700241680
		New Zealand	700241698
Digital Station	IP400 Digital Station 16 V2	All	700359839
	IP400 Digital Station 30 V2	All	700359847
	IP400 Digital Station 16	All	700184807
	IP400 Digital Station 30	All	700184880
Phone	IP400 Phone 8 V2	All	700359896
	IP400 Phone 16 V2	All	700359904
	IP400 Phone 30 V2	All	700359912
	IP400 Phone 8	All	700184773
	IP400 Phone 16	All	700184781
	IP400 Phone 30	All	700184799
SO (BRI)	IP400 So8	All	700185077
WAN	IP400 WAN3	All	700185028
	IP400 WAN3 10/100	All	700262009

Internal Cards

Variants		Country	SAP Code	SOE	IP406 V2	IP412	IP500
Modem Cards	Modem 2 Card	All	700185226	✗	✓	✓	✗
	Internal Modem Card	All	700343452	✗	✓	✓	✗
Embedded Voicemail Memory Cards	Small Office Edition	All	700289721	✓	✗	✗	✗
	IP406 V2	All	700343460	✗	✓	✗	✓
Wireless Cards	Small Office Edition	All	700289739	✓	✗	✗	✗
IP400 Voice Compression Modules (25ms)	VCM 5	All	700185119	✗	✓	✓	✗
	VCM 10	All	700185127	✗	✓	✓	✗
	VCM 20	All	700185135	✗	✓	✓	✗
	VCM 30	All	700293939	✗	✓	✓	✓
IP400 Voice Compression Modules (64ms)	VCM 4	All	700359854	✗	✓	✓	✓
	VCM 8	All	700359862	✗	✓	✓	✓
	VCM 16	All	700359870	✗	✓	✓	✓
	VCM 24	All	700359888	✗	✓	✓	✓

Power Supply Units

The following power supply units are used with IP Office control units and expansion modules. Normally the appropriate PSU is supplied with the IP Office control unit or expansion module. Note however that a locale specific power cord is not included with each control unit or expansion module.

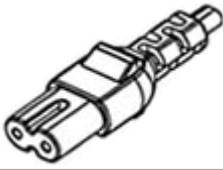
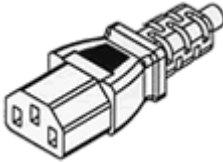
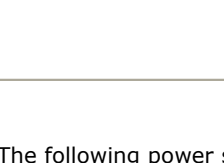
Variant	Used with	Country	SAP Code
 40W Unearthed PSU Uses IEC60320 C7 power cords.	<ul style="list-style-type: none"> • IP403. • IP406 V1. • Analog. • Digital Station V1. • Phone V1. 	All	700210792
 45W Earthed PSU Uses IEC60320 C13 power cord.	<ul style="list-style-type: none"> • Small Office Edition 	All	700284938
 60W Earthed PSU Uses IEC60320 C13 power cord.	<ul style="list-style-type: none"> • IP406 V2. • IP412. • Digital Station V2. • Phone V2. • So8. • WAN3 10/100. 	All	700357387

The following power supply units have various applications. They are used to provide power to 4600 Series and 5600 Series IP phones. They are also used to provide power to other phone types when those phones are supporting an XM24, EU24 or EU24BL add-on unit. Note: An appropriate locale specific power cord is required for the power supply unit. These units are not support for use with 1600 Series phones.

Variant	SAP Code
1151D1 Power Supply.	With CAT5 cable. 700434897
1151D2 Power Supply with battery backup.	With CAT5 cable. 700434905
1151D1/1151D2 Power Cord.	USA 405362641
	Europe 407786623
	Australia and New Zealand 407786631
	India 407790591
	United Kingdom 407786599
	Argentina 408161453



The following items are associated with providing IEEE 802.3af Power-over-Ethernet (PoE) to devices including Avaya IP phones. For full details refer to the IP Office IP Phone Installation Manual.

Variant	SAP Code
1U Mid-Span Power Distribution Unit	6 Ports 700409675
	6 Ports + SNMP 700409691
	12 Ports* 700250525
	12 Ports + SNMP* 700253107
	24 Ports* 700180433
	24 Ports + SNMP 700409717
Cisco Catalyst Power Adapter*.	700259369

*These items are no longer available as new from Avaya.

Power Cords

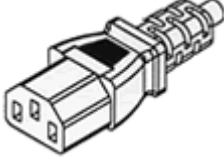
IP Office control unit and expansion module power supply units are not supplied with a power cord. The appropriate power cord must be ordered or sourced locally.

Power Cord Type	Power Outlet Plug Type	Locales	SAP Codes
 <p>Control Units</p> <ul style="list-style-type: none"> • IP500. • IP406 V2. • IP412.* • Small Office Edition. <p>IP400 External Expansion Modules</p> <ul style="list-style-type: none"> • Digital Station V2. • Phone V2. • So8.* • WAN3 10/100.* 	CEE7/7 (Schuko)	Europe and South Africa.	700289762
	BS1363	Czech Republic, Ireland, United Kingdom.	700289747
	NEMA5-15P / CS22.2 No.42	North, Central and South America.	700289770
	CPCS-CCC	China.	700261977
 <p>IP400 External Expansion Modules</p> <ul style="list-style-type: none"> • Analog. • Digital Station V1. • Phone V1. 	CEE7/16 (Europlug)	Europe and South Africa.	700213382
	BS1363	Czech Republic, Ireland, United Kingdom.	700213374
	NEMA1-15	North, Central and South America.	700213390
		Korea.	700254519
		China.	700314172

The following additional power cords are available for use with the Avaya 1151D1 and 1151D2 power supply units.

1151D1/1151D2 Power Cord	SAP Code
USA	405362641
Europe	407786623
Australia and New Zealand	407786631
India	407790991
United Kingdom	407786599
Argentina	408161453

Cables

Cable	Description	SAP Code	Length
25-Way DTE Cable	Connects to a IP403 or IP406 V1 control unit. 25-Way D-type plug to 9-way D-type socket.	700213432	2m/6'6".
9-Way DTE Cable	Connects to an SOE, IP406 V2 or IP412 control unit. 9-Way D-type plug to 9-way D-type socket.	-	2m/6'6".
Structured Cabling DS Line Cable	Connects from RJ45 sockets to RJ11 socketed DS and analog phones.	700047871	4m/13'2".
BRI/PRI Trunk Cable	Connects BRI/PRI trunk ports to the line providers network termination point. RJ45 to RJ45. Red.	700213440	3m/9'10".
IP500 BRI So Converter Cable	Provides the 100ohm terminating resistors necessary for an IP500 BRI trunk daughter card port set to S-Bus mode. Also provides the cable crossover. RJ45 plug to RJ45 socket.	700458649	25cm/10"
Expansion Interconnect Cable	Connects the control unit to expansion modules (except WAN3 modules). RJ45 to RJ45. Blue.	700213457	1m/3'3".
LAN Cable	Connects from IP Office LAN ports to IP devices. RJ45 to RJ45. Grey.	700213481	3m/9'10".
LAN Interconnect Cable	Connects WAN3 module to the control unit. Replace with a LAN crossover cable for IP412 control units. Green.	700213465	1m/3'3".
LAN Crossover Cable	Used for connection of IP devices to LAN ports on the IP412 control unit. Black	700213473	3m/9'10".
V.24 WAN Cable	37-Way D-type plug to 25-way D-type plug.	700213416	3m/9'10".
V.35 WAN Cable	37-Way D-type plug to 34-way MRAC plug.	700213424	3m/9'10".
X.21 WAN Cable	37-Way D-type plug to 15-way D-type plug.	700213408	3m/9'10".

Mounting

Rack Mounting Kits	SAP Code	Note
IP400 Rack Mounting Kit	700210800	One per IP400 control unit or IP400 external expansion module.
IP500 Rack Mounting Kit	700429202	One per IP500 control unit or IP500 external expansion module.
IP500 Wall Mounting Kit	700430150	One per IP500 control unit.
IP500 Blanking Plate Kit	700429194	Includes 3 front panels for the IP500 control unit.
Barrier Box Rack Mounting Kit	700293905	Up to 8 IP Office Barrier Boxes.

Barrier Boxes

IP Office Barrier Boxes	SAP Code	
IP400 Phone Barrier Box	700293897	Use with Phone V1 module. Includes an RJ45 to RJ11 cable and functional earth lead.
IP400 Phone Barrier Box V2 (101V)	700385495	Use with Phone V2 module. Includes an RJ45 to RJ11 cable and functional earth lead.

Feature Keys Dongles

Feature Key Dongle	SAP Code
Parallel Port Feature Key	700185234
USB Port Feature Key	700261506
Serial Port Feature Key	700293095
Smart Card Feature Key (MU-Law)	700417470
Smart Card Feature Key (A-Law)	700417488

CCC Licenses

License	RFA Name	SAP	
CCC Server	IP400 CCC SV	171994	
CCC Agents	IP400 CCC AGT	5	171995
		10	174469
		20	174470
		50	174471
CCC Supervisors	IP400 CCC SUP	1	171996
		5	184730
		10	184731
		20	184732
CCC PC Wallboards	IP400 CCC PCW	5	172786
		10	174472
		20	174473
		50	174474
CCC Spectrum Wallboards	IP400 CCC Wallboard	4	176196
Report Viewer	IP400 CCC Report	5	184726
		10	184727
		20	184728
CCC Agent Rostering	IP400 CCC Rostering		171997
CCC Designer (users)	IP400 CCC Designer		171999

CTI Licenses

License	RFA Name	SAP
CTI Link Pro	IP400 CTI RFA	171988
Wave User	IP400 TAPI WAV RFA 4	177466

General Licenses

License	RFA Name	SAP	
DECT Integration (ports)	IP400 CTI DECT	8	171989
		16	174457
		64	174458
Conferencing Center	IP400 Conferencing Center	182302	
SoftConsole (users)	IP400 SoftConsole	171987	
Compact Business Center	IP400 CBC	171993	
Small Office Edition WiFi	IP400 Access Point	182197	
Microsoft CRM Integration (users)	IP400 Microsoft CRM Intgr	180588	
IPSec Tunneling	IP400 IPSec VPN	182301	
Mobile Twinning or Mobility Features	IPO Lic Mobile Twinning	1	195569
		5	195570
		10	195571
		20	195572
		50	195573
SIP Trunk Channels	IPO LIC SIP TRNK RFA	1	202967
		5	202968
		10	202969
		20	202970
Advanced Small Community Networking	IPO LIC ADVANCED NTWKG	202966	
IP End-points	IP400 IP Endpoint	1	174956
		5	174957
		10	174958
		20	174959
		50	174960
		100	174961
VPN IP Extensions	VPN Phone	1	213980
		5	213981
		10	213982
		25	213983
		50	213984
		100	213985
		Unlimited	213986
Trial (10)	213987		

IP500 Licenses

License	RFA Name		SAP
IP500 Upgrade Standard to Professional	IP500 IPO EXP UPG TO PRO		202959
IP500 Voice Networking	IP500 VOICE NTKWG BASE 4 LIC	4	202960
	IP500 VOICE NTKWG ADD LIC	-	205450
IP500 Universal PRI (Additional channels)	IP500 T1 Channels Add	2	21580
		8	21581
		32	21582
	IP500 E1 Channels Add	2	21583
		8	21584
		32	21585
	IP500 E1R2 Channels Add	2	21586
		8	21587
		22	21588
IP500 VCM Channels	IP500 VCM LIC 4 CH	+4	202961
	IP500 VCM LIC 8 CH	+8	202962
	IP500 VCM LIC 16 CH	+16	202963
	IP500 VCM LIC 28 CH	+28	202964
	IP500 VCM LIC 60 CH	+60	202965

Phone Manager Licenses

License	RFA Name		SAP
Phone Manager Pro (per seat)	IP400 Phone Manager Pro	1	177468
		5	177469
		10	177470
		20	177471
		50	177472
Phone Manager Pro IP Audio Enabled (per user)	IP400 IPPRO	1	171992
		5	174463
		10	174464
		20	174465
		50	174466

Voicemail Licenses

License	RFA Name	SAP	
AUDIX Voicemail	IP400 AUDIX	177467	
Voicemail Pro (4 ports)	IP400 Voicemail Pro	171991	
Additional Voicemail Pro (ports)	IP400 Voicemail Pro	2	174459
		4	174460
		8	174461
		16	174462
VMPro Networked Messaging	IP400 Networked Messaging	182297	
Integrated Messaging	IP400 Integrated Messaging Pro	171990	
VMPro TTS (ScanSoft)	IP400 Avaya TTS	182299	
VMPro TTS (Generic)	IP400 3rd Party TTS	182303	
VMPro VB Script	IP400 VB Scripting	182300	
VMPro Database Interface	IP400 3rd Party IVR	182298	
VMPro Recordings Administrators	IP400 ContactStore for IPO	187166	
UMS Web Services	IPO LIC VMPRO UMS	1	217880
		5	217881
		10	217882
		20	217883
		50	217884
		Trial	217890

IP DECT Licenses

See [IP DECT section](#). IP DECT licenses are entered into the IP DECT system configuration, not the IP Office configuration.

60 Day Trial Licenses

These licenses start expiring from the day the license is generated, not the date of installation. Each license will only be generated once for a given Feature Key dongle serial number.

License	RFA Name	SAP
Voicemail Pro Networked Messaging	IPO TRIAL NTWKD MSGING LIC:DS	189776
3rd Party Database/IVR	IPO TRIAL 3RD PARTY IVR RFA LIC:DS	189777
Avaya Text-to-Speech for IP Office (1 port)	IPO TRIAL AVAYA TTS RFA 1 LIC:CU	189778
VB Scripting	IPO TRIAL VB SCRIPTING RFA LIC:DS	189779
Conferencing Center	IPO TRIAL CONF CENTER RFA LIC:DS	189780
Third Party Text to Speech (1 port)	IPO TRIAL 3RD PRTY TTS RFA LIC:CU	189781
Voicemail Pro (4 ports)	IPO TRIAL VM PRO RFA LIC:DS	189782
SoftConsole (1 user)	IPO TRIAL SOFTCONSOLE/BLF RFA LIC:CU	189783
Phone Manager PC Softphone (10 users)	IPO TRIAL IPPRO RFA 10 LIC:CU	189784
Phone Manager Pro (10 users)	IPO TRIAL PMGR PRO RFA 10 LIC:CU	189785
Centralized Voicemail with Avaya Messaging	IPO TRIAL ACM CENTRAL VM LIC:DS	189786
Integrated Messaging Pro	IPO TRIAL INTG MSGING PRO RFA LIC:DS	189787
Mobile Twinning (5 users)	IPO LIC MOBILE TWINNING TRIAL RFA 5	195574
VPN IPSec	IPO TRIAL IPSEC VPN RFA LIC:DS	189788
IP500 Upgrade Standard to Professional	IPO LIC IP500 STD UPG to PRO TRIAL	205822
VPN IP Phone	IPO LIC VPN PHONE 10 TRIAL	213987
UMS Web Services (10 users)	IPO TRIAL UMS 10 LIC:CU	217890

IP Office Application CDs

Application	Variant	SAP Code
Voicemail Pro CD	4.2	700459357
	4.1	700448954
	4.0	700428592
	3.2	700407588
	3.1	700380405
	3.0	700350457
	2.1	700330970
	2.0	700304546
Voicemail Pro ScanSoft Text-to-Speech (TTS)	-	700293921
Conferencing Center	3.2	700407596
	3.1	192226
	3.0	700372287
	2.1	700293913
IP Office Software Developer's Kit (SDK)	-	700188873
Compact Contact Center (CCC)	5.2	700451545
	5.0	700330962
	4.0	700188881
IP Office User and Administration CD Set	4.2	700459332
	4.1	700449457
	4.0	700428576
	3.2	700407604
	3.1	700380389
	3.0	700345879
	2.1	700329725
	2.0	700304074
IP Office Applications DVD	4.2	700459340
	4.1	700449465
	4.0	700428584
	3.2	700407612
	3.1	700380397

1600 Series Phones

Material Description	SAP Code
Phones and Modules	
1603 IP PHONE	700415540
1608 IP PHONE	700415557
1616 IP PHONE	700415565
BM32 BUTTON MODULE	700415573
Accessories	
CAT5 Ethernet Cable (14 FT)	700383326
CAT5 Ethernet Cable (1FT)	700436710
1608 Wall Mount Kit (Includes 1ft ethernet cable)	700415623
1616 Wall Mount Kit (Includes 1ft ethernet cable)	700415631
1600 SERIES BM32 CABLE - REPLACEMENT	700415581
1600 SERIES BM32 BOND BRIDGE - REPLACEMENT	700415599
1603 PLASTIC LABEL COVERS (10) - REPLACEMENT	700419831
1608 PLASTIC LABEL COVERS (10) - REPLACEMENT	700415664
1616/BM32 PLASTIC LABEL COVERS (20) - REPLACEMENT	700415672
1603 WEDGE STAND - REPLACEMENT	700415615
1608 FLIP STAND - REPLACEMENT	700415714
1616 FLIP STAND - REPLACEMENT	700415722
1600 SERIES BM32 FLIP STAND - REPLACEMENT	700432800
1600 SERIES HANDSET - REPLACEMENT	700427495
1600 SERIES 9' HANDSET CORD - REPLACEMENT (BLACK)	700429707
9600/1600 SERIES 25' HANDSET CORD (GREY)	700383821
Power Supply	
1603 PoE adapter	700415607
Power Adapter for 1600 IP Phones 5V US	700451230
Power Adapter for 1600 IP Phones 5V UK	700451248
Power Adapter for 1600 IP Phones 5V EU	700451255
Power Adapter for 1600 IP Phones 5V Argentina	700451263
Power Adapter for 1600 IP Phones 5V Korea	700451271
Power Adapter for 1600 IP Phones 5V China	700451289
Power Adapter for 1600 IP Phones 5V Australia	700451297
Power Adapter for 1600 IP Phones 5V (3 Prong) Israel	700459795
Paper Labels	
1603 PAPER DESI LABELS - PACKAGE OF 50 LABELS (8.5" x 11")	700415706
1608 PAPER DESI LABELS - PACKAGE OF 50 LABELS (8.5" x 11")	700415649
1616/BM32 PAPER DESI LABELS - PACKAGE OF 50 LABELS (8.5" x 11")	700415656
1603 PAPER DESI LABELS - PACKAGE OF 50 LABELS (A4)	700434210
1608 PAPER DESI LABELS - PACKAGE OF 50 LABELS (A4)	700434228
1616/BM32 PAPER DESI LABELS - PACKAGE OF 50 LABELS (A4)	700434236

2400 Series Phones

Variant		SAP Code
2402	Multi-grey	700381973
2410	Multi-grey	700381999
2420D	Multi-grey	700381585
Replacement Handset	Dark Grey	700203797
Amplified Handset	Dark Grey	700229735
Noisy Location Handset	Dark Grey	700229743
Push to Talk Handset	Dark Grey	700229727
201B Recorder Interface for 2420/5420D		700381635

3600 Series Phones

Variant		SAP Code
3616 Wireless Phone.		700413040
3620 Wireless Phone.		700413065
Additional battery pack for 3616		700277387
Desktop charger for 3616.		700412901
Belt Clip for 3616.		700413057
3626 Wireless Phone.		700413024
Additional battery pack for 3626		700277395
Desktop charger for 3626		700412919
Charger Power Supply	Europe	700412810
	United Kingdom	700412828
	Switzerland	700412836
3626 8-Gang changer.		700412927
Belt Clip for 3626.		700413131
3626 Vinyl case with keypad cover.		700412984
3626 Carry case.	Yellow	700289309
3626 Carry case with keypad cover	Black	700289317
	Yellow	700289325
3616/3626 Configuration Cradle		700375934
Avaya Voice Priority Processor 10 (AVPP 10)		700413164
Avaya Voice Priority Processor 20 (AVPP 20)		700413172
AVPP Power Supply	Europe	700412844
	United Kingdom	700412851
	Switzerland	700412869
Netlink OAI Gateway		700245756
Rack Mount Kit		700245459

Variant	SAP Code
AWTS 3641 WRLS PHONE.	700430408
AWTS 3645 WRLS PHONE.	700430416
AWTS 3641 Single Charger Bundle- includes phone, standard battery and single charger.	700436736
AWTS 3645 Single Charger Bundle- includes phone, single charger and standard battery.	700436744
AWTS 3641 Dual Charger Bundle- includes phone, dual charger and two extended batteries.	700436751
AWTS 3645 Dual Charger Bundle- includes phone, dual charger and two extended batteries.	700436769

3700 Series Phones

See IP DECT section.

3810 Phones

Item	SAP Code
3810 Set - Includes phone, base station, charger, belt clip and power supply units for charger and base station.	700305105

4400 Series Phones

Variant		SAP Code
4406D+	White	108199019
	Black	108199027
4412D+	White	108199043
	Black	108199050
4424D+	White	108199076
	Black	108199084
DSS4450	White	108199407
	Black	108199696
Power Supply for 4450	-	108596412
Small Stand for 4406 or 4450	Black	108541194
	White	108541202
Large Stand for 4412D+ or 4424D+.	Black	108541269
	White	108541277

4600 Series Phones (New Style)

Variant		SAP Code
4601+	Multi-grey	700381890
4602IP	Multi-grey	700221260
4602SW+	Multi-grey	700381916
4610SW	Multi-grey	700381957
4620IP	Multi-grey	700212186
4620SW	Multi-grey	700259674
4621SW	Multi-grey	700345192
4625SW	Multi-grey	700381551
EU24 1XU-A Expansion Module	Multi-grey	700381817
EU24BL 2XU-A Backlighted Expansion Module	Multi-grey	700381825
Replacement Handset	Dark Grey	700203797
Amplified Handset	Dark Grey	700229735
Noisy Location Handset	Dark Grey	700229743
Push to Talk Handset	Dark Grey	700229727

5400 Series Phones

Variant		SAP Code
5402	Multi-grey	700381981
5410	Multi-grey	700382005
5420	Multi-grey	700381627
EU24	Multi-grey	700381817
EU24BL	Multi-grey	700381825
Replacement Handset	Dark Grey	700203797
Amplified Handset	Dark Grey	700229735
Noisy Location Handset	Dark Grey	700229743
Push to Talk Handset	Dark Grey	700229727
201B Recorder Interface for 2420/5420D		700381635

5600 Series Phones

Variant		SAP Code
5601+	Multi-grey	700381908
5602SW+	Multi-grey	700381932
5610SW	Multi-grey	700381965
5621	Multi-grey	700385982
EU24	Multi-grey	700381817
EU24BL	Multi-grey	700381825
Replacement Handset	Dark Grey	700203797
Amplified Handset	Dark Grey	700229735
Noisy Location Handset	Dark Grey	700229743
Push to Talk Handset	Dark Grey	700229727

6400 Series Phones

Variant		SAP Code
6408D+	Grey	70020100
	White	70020092
6416D+M	Grey	108807611
	White	108807603
6424D+M	Grey	108807595
	White	108807587
6408 Stand	Grey	108933169
	White	108933177
6416/6424 Stand	Grey	848219127
	White	848219119
XM24	Grey	700406523
	White	700406515
XM24 Stand	Grey	108272378
	White	108272386

T3 Series Phones (Upn)

Variant		SAP Code
T3 Compact	Black	700380264
	White	700380298
T3 Classic	Black	700380272
	White	700380306
T3 Comfort	Black	700380280
	White	700380314
T3 DSS Unit	Black	700380322
	White	700380330
T3 DSS Expansion Unit	Black	700380348
	White	700380355
T3 Headset Link Unit	-	700380363

T3 Series Phones (IP)

Variant		SAP Code
T3 Compact	Black	700414717
	White	700414709
T3 Classic	Black	700414733
	White	700414725
T3 Comfort	Black	700414758
	White	700414741
Power Supply Unit for T3 IP Phones		700414766
T3 AEI/Headset Link for IP Phones		700414774
Power Supply Unit for DSS on T3 IP Phone		700414790

Spares

The following spares can be ordered from Avaya.

Item	Color	SAP Code
Handset HIP QD CORD- 4606/16/24/30 SETS		700414121
Cat 5 Cable specific to 4620		700261613
Handset Cords 25ft	Dark Grey	700217417
IP PHONE MOD CORD 1ft CAT5	-	408406932
IP PHONE MOD CORD 7ft CAT5	-	408406957
IP PHONE MOD CORD 14ft CAT5	-	408406940

IP DECT Handsets and Handset Accessories

Handsets are supplied with 3 AAA rechargeable batteries and a charger. Region specific power adaptor for the charger must be ordered separately.

Item	Region	SAP Code
IP DECT 3701 Handset	EMEA	700346802
IP DECT 3711 Handset	EMEA	700346810
	North America	700430267
Belt Clip		700346885
Phone Charger for 3701/3711 Requires power adaptor below.	Global	700346828
Power Adaptor for Charger	European	700346836
	United Kingdom	700346844
	Australia	700378318
	North America	700430309
Rack mount 8-phone charger Requires power adaptor below.	Global	700346851
Power Adaptor for Rack Mount Charger Require region specific IEC60320 C13/C14 power cord ordered separately.	Global	700346869
Power Cord IEC60320 C13	Europe	700289762
	United Kingdom	700289747
	North America	700289770
IP DECT Phone Firmware Upgrade RS232 Serial Cable	EMEA	700379688
IP DECT Phone Firmware Upgrade USB Cable	North America	700436603
Leather Case for 3711	Global	700436629
IP DECT Headset for 3701/3711	Global	700346950

IP DECT Base Stations

Item	Region	SAP Code
RFP32 Indoor Base Station Requires power adaptor or PoE. Note: These are not pre-licensed 'plug and play' base stations, see below for those items.	North America	700430275
	EMEA	700420789
Power Adaptor for RFP32	North America	700430291
	Europe	700346901
	United Kingdom	700346919
	Australia	700378326
RFP34 Outdoor Base Station PoE only. Note: These are not pre-licensed 'plug and play' base stations, see below for those items.	North America	700430283
	EMEA	700420797
Outdoor Base Station Wall Mounting Kit	Global	700378334
Outdoor Base Station Mast Mounting Kit (65mm)	Global	700347156
Outdoor Base Station Mast Mounting Kit (>65mm)	Global	700347172
External Dipole Aerial (pair)	EMEA	700346935
External Beam Aerial (pair)	EMEA	700346943
Mounting Kit for External Aerials	EMEA	700347149
External Aerial Connection Cable (0.5m)	EMEA	700347115

Plug and Play IP DECT Kits

Item	Region	SAP Code
IP DECT Starter Kit Includes 2 RFP32 base stations.	North America	700436538
	EMEA	700378995
RFP32 Upgrade Kit	North America	700436579
	EMEA	700436561
RFP34 Upgrade Kit	North America	700436595
	EMEA	700436587

IP DECT Site Survey Kits

Item	Region	SAP Code
IP DECT Survey Kit with Tripod Includes custom RFP, 2 handsets, charger, charger power adaptor and tripod.	North America	700436512
IP DECT Survey Kit without Tripod Includes custom RFP, 2 handsets, charger, charger power adaptor.	Europe	700378284
	United Kingdom	700378292
Tripod for IP DECT Survey Kit	Global	700378300

IP DECT Licenses

Item	Region	SAP Code
IP DECT License for 1 RFP	All	700379027
IP DECT License for 2 RFP's	All	700379035
IP DECT License for 3 to 5 RFP's	All	700379043
IP DECT License for 6+ RFP's	All	700379050
IP DECT License for upgrade from 1 to 2 RFP's	All	700379068
IP DECT License for upgrade from 2 to 3-5 RFP's	All	700379076
IP DECT License for Upgrade to 6+ RFP's	All	700379084
IP DECT License Conversion from IP Office to CM	All	700379167

11.13.1 Availability

SAP codes and details of specific items within this documentation are for reference only. Items available in any specific locale should be confirmed against the local Avaya IP Office price list for that locale. The local price list may also include additional items relative to the installation requirements of that locale.

11.13.2 RoHS

RoHS is an European Union directive for the Removal of Certain Hazardous Substances from Electrical and Electronic Equipment. Similar legislation has been or is being introduced in a number of other countries. Avaya has decided to make its global product range compliant with the requirements of RoHS. The actions taken vary

- In some cases equipment has been discontinued and is no longer available from Avaya.
- In some cases new manufactured stock has been made RoHS compliant and keeps its existing SAP code.
- In other cases the equipment has been replaced by a new RoHS compliant alternative with new SAP codes.

The SAP codes within this document are for RoHS compliant equipment unless otherwise stated.

Chapter 12.

Safety Statements

12. Safety Statements

12.1 Safety and Homologation Statements

• CE

The CE mark affixed to this equipment means that the module complies with the 1999/5/EC (R&TTE), 89/336/EEC (EMC) and 72/23EEC (LVD) Directives.

• Declaration of Conformity

The Declaration of Conformity (DoC) for the IP400 Office products is available within on the IP Office Documentation CD (Engineer's Toolkit CD).



- This warning symbol is found on the base of IP406 V2, IP412 and IP500 modules.
- Refer to [Trunk Interface Modules](#) for information concerning which Trunk Interface module variants are fitted in which country.

WARNING

The Avaya IP400 Office and IP500 Office modules are intended to be installed by 'Service Personnel' and it is the responsibility of the Service Personnel to ensure that all subsidiary interconnected equipment is wired correctly and also meet the safety requirements of IEC60950 or UL60950 where applicable.

12.2 Lithium Batteries

A lithium battery is fitted to the real time clock on IP Office control unit mother boards.

WARNING

The Lithium battery must only be replaced by Avaya personnel or authorized representatives. There is a danger of explosion if the battery is incorrectly replaced. Replace only with the same or equivalent type recommended by the manufacturer. Dispose of used batteries according to the manufacturer's instructions.

12.3 Lightning Protection/Hazard Symbols

Lightning protectors

The buildings lightning protectors must be verified as follow:

1. Check the lightning protectors, at the trunk cable entry point to the building housing the Avaya IP Office, paying special attention to the lightning protection grounding. Report any problems, in writing, to the telephone company.
2. Equipment that is designed to be connected using internal wiring is typically not lightning protected. Hence, Avaya IP Office extension cabling must not leave the building. For installations where telephones and/or other standard (tip/ring) devices are installed in another building then lightning protection is required (see [Out of Building Telephone Installations](#)).

Hazard Symbol



- The shock hazard symbol is intended to alert personnel to electrical hazard or equipment damage. The following precautions must also be observed when installing telephone equipment:
 2. Never install telephone wiring during a lightning storm.
 3. Never install telephone jacks in wet locations unless the jack is specifically designed for wet locations.
 4. Never touch uninsulated telephone wires or terminals unless the telephone line has been disconnected at the network interface.
 5. Always use caution when working with telephone lines.

12.4 Trunk Interface Modules

To ensure the validation of the approvals, only the following types of trunk interface cards must be fitted in the following IP Office control units.

USA/Canada							
Product	Quad BRI	PRI E1		PRI T1		ATM4	WAN
		Single	Dual	Single	Dual		
IP500 Office	✗	✗	✗	✓	✓	✓	✗
IP406 V2 Office	✗	✗	✗	✓	✓	✓	✗
IP412 Office	✗	✗	✗	✓	✓	✓	✗
Small Office Edition	✗	✗	✗	✓	✗	✗	✓

Rest of World							
Product	Quad BRI	PRI E1/E1R2		PRI T1		ATM4	WAN
		Single	Dual	Single	Dual		
IP500 Office	✓	✓	✓	✗	✗	✓	✗
IP406 V2 Office	✓	✓	✓	✗	✗	✓	✗
IP412 Office	✓	✓	✓	✗	✗	✓	✗
Small Office Edition	✓	✗	✗	✗	✗	✗	✓

Notes

- Single WAN trunk card is only supported in the Small Office Edition control unit.
- Small Office Edition control units include 4 integral analog trunk ports.
- E1R2 trunks are only supported in CALA and Korea.

12.5 Further Information and Product Updates

Further information, including Product and Reference Manual updates, can be obtained from Avaya's Dealers and Distributors, or from Avaya's web site: <http://www.avaya.com>.

This guide is also available from the Avaya's support web site: <http://support.avaya.com>.

Support Telephone Numbers

For initial help and support, contact your distributor/supplier. The following contact points are for Avaya authorized partners.

- In the USA only
Avaya provides a toll-tree Customer Helpline 24 hours a day:
 - Name: Avaya Technical Support Organization (TSO)
 - Customer Helpline: 1 800 628-2888
 - Address: 8744 Lucent Blvd., Highlands Ranch, Colorado, 80129 USA
 - URL: <http://support.avaya.com>
If you need assistance when installing, programming, or using your system, call the Helpline or your Avaya representative. Consultation charges may apply.
- Outside the USA
If you need assistance when installing, programming, or using your system, contact your Avaya representative.
 - URL: <http://support.avaya.com>

12.6 Compliance with FCC Rules

Transmit and Receive Gain Settings for PRI/T1 and Analog Ports

The Gain settings are password controlled for use by qualified installation personnel only and must not be made available to the end user. The default gain settings of 0dB ensures compliance with FCC part 68 section 68.308(b)(5) and TIA/EIA-IS-968 Section 4.5.2.5. "Through transmission amplification from ports for the connection of separately registered equipment or from other network connection ports". Gain setting adjustment by unqualified personnel may result in violation of the FCC rules. Qualified personnel may adjust gain settings above these levels only where:

1. Measurement is made to ensure that the power levels sent to line at each network interface connected does not exceed the maximum levels specified in FCC part 68 section 68.308(b) and TIA/EIA-IS-968 Section 4.5 for that specific interface type.
2. Where gain adjustment away from the default values are made, precautions should be taken to ensure that the connection of terminal equipment is controlled by qualified installation personnel.

12.7 Port Safety Classification

The Avaya IP Office systems have the following ports which are classified as follows:

Port Name	Port Description	Port Classification
PRI port	PRI ISDN connection (NET)	TNV (Operating within the limits of SELV)
BRI ports	BRI ISDN connection (NET)	TNV (Operating within the limits of SELV)
Analog ports	Two wire analog trunk	TNV3
Power fail ports	Two wire analog trunk	TNV3
DTE port	Async Data connection.	SELV
Analog Telephone Ports	Telephone Extension ports	TNV2
Digital Telephone Ports	Telephone Extension ports	SELV
WAN port	WAN connection (NET).	SELV
LAN ports	10/100 BaseT attachment to LAN.	SELV
Expansion ports	Expansion Module connector.	SELV
Audio port	Connector for Music on Hold.	SELV
External Control port	Connector for Controlling Ancillary circuits.	SELV
DC Input port	Connector for DC input power.	SELV

Interconnection circuits shall be selected to provide continued conformance with the requirements of EN 609050:1992/A3:1995 clause 2.3 for SELV circuits and with the requirements of clause 6 for TNV circuits, after connections between equipment.

12.8 EMC Directive

889/336/ EEC (EMC Directive) CISPR 22:1993 including A1 + A2, AS/NZ 3548:1995 (ROW)

- **WARNING**

This is a class A product. In a domestic environment this product may cause radio interference in which case the user may be required to take adequate measures.

Federal Communications Commission (FCC)

This equipment has been tested and found to comply with the limits for a Class A digital device, pursuant to Part 15 of the FCC Rules. These limits are designed to provide reasonable protection against harmful interference when the equipment is operated in a commercial environment. This equipment generates, uses, and can radiate radio frequency energy and, if not installed and used in accordance with the instruction manual, may cause harmful interference to radio communications. Operation of this equipment in a residential area is likely to cause harmful interference, in which case the user will be required to correct the interference at his or her own expense.

Canadian Department of Communications (DOC)

"NOTICE: This equipment meets the applicable Industry Canada Terminal Equipment Technical Specifications. This is confirmed by the registration number. The abbreviation, IC, before the registration number signifies that registration was performed based on a Declaration of Conformity indicating that Industry Canada technical specifications were met. It does not imply that Industry Canada approved the equipment."

EMC Caution for China

警示

注意：此为A级产品，在生活环境中，该产品可能会造成无线电干扰。在这种情况下，可能需要用户对其干扰采取切实可行的措施。仅适用于商业或工业环境。

12.9 Regulatory Instructions for Use

12.9.1 Australia

Connection

Connection of IP400 Office products must be via a Line Isolation Module with a telecommunications compliance label.

BRI Interface

During the configuration, ensure "000" emergency number is not barred, by performing the following:

- Short Code: 000
- Telephone No: 000;
- Function: DialEmergency

Connections to TS013, the following Bearer Capabilities shall not be used:

- 7kHz Audio, Video, Restricted Digital Information.

If unknown type of number is used in calling party number, the network will use the default CLI.

The system must be configured for Point to Multi point connection to comply with Austel requirements for connecting to TS013 circuits.

As the IP Office does not support emergency dialing after loss of power, the following warning notice should be recognized:

- WARNING
This equipment will be inoperable when mains power fails.

PRI Interface

During the configuration, ensure "000" emergency number is not barred, by performing the following:

- Short Code: 000
- Telephone No: 000;
- Function: DialEmergency

- WARNING
This equipment will be inoperable during mains power failure.

12.9.2 Canada

This equipment meets the applicable Industry Canada Terminal Equipment Technical Specifications. This is confirmed by the registration number. The abbreviation, IC, before the registration number signifies that registration was performed based on a Declaration of Conformity indicating that Industry Canada technical specifications were met.

It does not imply that Industry Canada approved the equipment.

"NOTICE: The Ringer Equivalence Number (REN) for this terminal equipment is 1. The REN assigned to each terminal equipment provides an indication of the maximum number of terminals allowed to be connected to a telephone interface. The termination on an interface may consist of any combination of devices subject only to the requirement that the sum of the Ringer Equivalence Numbers of all the devices does not exceed five."

12.9.3 China



700433220

February 2007

Copyright© 2007, Avaya Inc. All Rights Reserved

所有在中华人民共和国境内进口或销售的电子信息产品必须附上本文件
Include this document with all Electronic Information Products imported or sold in the People's Republic of China

部件名称 (Part Name)	有毒有害物质或元素 (Hazardous Substance)					
	铅 (Pb)	汞 (Hg)	镉 (Cd)	六价铬 (Cr ⁶⁺)	多溴联苯 (PBB)	多溴二苯醚 (PBDE)
金属部件 (Metal Parts)	×	○	○	○	○	○
电路模块 (Circuit Modules)	×	○	○	○	○	○
电缆及电缆组件 (Cables & Cable Assemblies)	×	○	○	○	○	○
塑料和聚合物部件 (Plastic and Polymeric parts)	○	○	○	○	○	○
电路开关/断路器 (Circuit Switch/Breakers)	○	○	○	○	○	○
电源组件 (Power Assemblies)	×	○	○	○	○	○
显示器 (LCD, Monitor)	○	○	○	○	○	○
玻璃 (Glass)	○	○	○	○	○	○

○：表示该有毒有害物质在该部件所有均质材料中的含量均在 SJ/T 11363 2006 标准规定的限量要求以下。
Indicates that the concentration of the hazardous substance in all homogeneous materials in the parts is below the relevant threshold of the SJ/T 11363 2006 standard.

×：表示该有毒有害物质至少在该部件的某一均质材料中的含量超出 SJ/T 11363 2006 标准规定的限量要求。
Indicates that the concentration of the hazardous substance of at least one of all homogeneous materials in the parts is above the relevant threshold of the SJ/T 11363 2006 standard.

本表显示，所附的亚美亚电子信息产品中，从生产日期起，可能包含这些物质。注意：所附产品可能包含或不包含以上所列的某些组件。

This table shows where these substances may be found in Avaya's electronic information products, as of the date of manufacture of the enclosed product. Note that some of the component types listed above may or may not be a part of the enclosed product.

除非有另外特别的标注,此标志将作为所附产品及零部件的环保使用期标志。某些产品会有一个不同的环保使用期(例如,电话机)并贴在其产品上。此环保使用期限只适用于产品在产品手册中所规定的条件下使用



The Environmentally Friendly Use Period (EFUP) for all enclosed products and their parts are per the symbol shown here, unless otherwise marked. Certain products have a different EFUP (for example, telephones) and so are marked to reflect such. The Environmentally Friendly Use Period is valid only when the product is operated under the conditions defined in the product manual.

12.9.4 European Union

1. 999 and 112 calls must not be barred. Doing so will invalidate the approval.
2. All connections at the MDF shall be identifiable by suitable labeling.
3. The CE mark displayed on IP Office equipment indicates the systems compliance with the EMC, LVD, and R&TTE Directives and common technical regulations for Primary Rate and Basic Rate ISDN.
4. All ports for the connection of other non-telecommunications apparatus have a Safety Extra Low Voltage (SELV) safety status.

12.9.5 New Zealand

The grant of a Telepermit for any item of terminal equipment indicates only that Telecom has accepted that the item complies with minimum conditions for connection to its network. It indicates no endorsement of the product by Telecom, nor does it provide any sort of warranty. Above all, it provides no assurance that any item will work correctly in all respects with another item of Telepermitted equipment of a different make or model, nor does it imply that any product is compatible with all of Telecom's network services.

12.9.6 FCC Notification

This equipment is registered with the ACTA (Administrative Council for Terminal Attachments) in accordance with FCC Part 68 of its rules. In compliance with those rules, you are advised of the following:

- **Means of Connection**
Connection of this equipment to the telephone network shall be through a standard network interface jack. Connection to 1.544-MBps digital facilities must be through a USOC RJ48C. Connection to the Analog Trunk facilities must be through a USOC RJ45S.
- **Notification to the Telephone Companies**
Before connecting this equipment, you or your equipment supplier must notify your local telephone company's business office of the telephone number or numbers you will be using with this equipment.
- The facility interface codes (FIC) for 1.544-MBps digital connection (i.e. IP400 Office PRI-T1) are 04DU9.BN, 04DU9.DN, 04DU9.IKN, 04DU9.ISN.
- The facility interface code (FIC) for analog trunk connection (i.e. IP400 Office Quad Analog Trunk-LS) are OL13A, OL13B, OL13C, 02AC2, 02LA2, 02LB2, 02LC2, 02LR2, 02LS2.
- The facility interface code (FIC) for analog trunk connection (i.e. IP400 Office ATM16-LS/GS) are OL13A, OL13B, OL13C, 02AC2, 02GS2, 02LA2, 02LB2, 02LC2, 02LR2, 02LF2.
- The Service Order Code (SOC) for 1.544-MBps digital connection (i.e. IP400 Office PRI-T1) is 6.0Y.
- The Service Order Code (SOC) for analog trunk connection (i.e. IP400 Office Quad Analog Trunk-LS) is 9.0Y.
- **Disconnection**
You must also notify your local telephone company if and when this equipment is permanently disconnected from the line or lines.
- **Hearing Aid Compatibility**
The custom telephone sets for this system are compatible with inductively coupled hearing aids as prescribed by the FCC.

Ringer Equivalence Number (REN). The REN is used to determine the number of devices that may be connected to the telephone line. Excessive RENs on the line may result in the devices not ringing in response to an incoming call. In most, but not all, areas, the sum of the RENs should not exceed five. To be certain of the number of devices that may be connected to the line, as determined by the total RENs, contact the local telephone company to determine the maximum REN for the calling area.

Index

2

- 2400 Series Phone
 - Checking Firmware 159
 - Desk Mounting 159
 - Installing 159
 - SAP Code 367
 - Software Upgrade 159
 - Wall Mounting 159

3

- 3600 Series Phone
 - SAP Code 367
- 3700
 - Series Phone SAP Code 367
- 3810
 - Phone SAP Code 367

5

- 5400 Series Phone
 - Checking Firmware 159
 - Desk Mounting 159
 - Installing 159
 - SAP Code 367
 - Software Upgrade 159
 - Wall Mounting 159
- 5600
 - Series Phone SAP Code 367

6

- 6400
 - Series Phone SAP Code 367

A

- Add-Ons
 - 201B Recorder 309
 - 4450 Features 304
 - EU24 Features 306
 - EU24BL Features 307
 - Programmable Buttons 304, 306, 307, 308, 310
 - T3 DSS Features 308
 - XM24 Features 310

Analog

- Phone Barrier Boxes 188
- Phone Region Availability 44, 263
- Port 350, 353
- Trunk Card 24

Application

- Call Center 52
- Call Logging 52
- Call Status 312
- CD/DVD 54
- Compact Business Center 313
- Compact Contact Center 314
- Conference Center 318
- ContactStore 319
- CTI 53
- Delta Server 320
- Feature Key Server 321
- Maintenance 49
- Manager 322
- Monitor 323
- MS-CRM 324
- Phone Manager 325
- SoftConsole 327
- System Status Application 328
- TAPI 329
- User 50

- Voicemail 51
- VoiceMail Lite 331
- VoiceMail Pro 332

Assessments

- Network 55
- VoIP 55

Audio

- Codec Conversion 56
- Port 350

Audio Port 353

Availability of Equipment 10, 386

B

Barrier Boxes

- Analog Phone 188
- Rack Mounting 190
- SAP Code 367

Base Card

- Analog Phone 21
- Digital Station 21
- Legacy Card Carrier 21
- VCM 21

Batteries

- Lithium 389

BRI

- (So) Port 354
- (Trunk) Port 355
- Port 350

Button Programming 166

C

Cable

- Access Requirements 62
- Clearance Requirements 62

Cables

- Maximum Cable Distances 36, 351
- SAP Code 367
- Standard IP Office 36, 351

Cabling

- Lightening Protection 39, 186

Call Logging Application 52

Call Status

- Application 49
- PC Requirements 312

Cards

- Analog Trunk 230, 231
- ATM4 231
- ATM4U 230
- BRI Trunk 231
- E1 PRI 232
- E1R2 PRI 233
- Embedded Voicemail Memory 31, 228
- IP400 Voice Compression Modules 31
- IP500 Analog Phone Base 237
- IP500 Digital Station Base 236
- IP500 Legacy Card Carrier 234
- IP500 VCM 235
- Modem 31, 227
- Small Office Edition Wireless 31
- T1 PRI 232
- VCM 229
- Voice Compression 229
- WAN Trunk 233
- Wireless 227

Castle Rock 200

CCC

- SAP Code 367

Channels	
Compression	56
Clock	174
Compact Business Center	
Application	52
PC Requirements	313
Compact Contact Center	
Application	52
Components	314
License Requirements	314
PC Requirements	314
Compression Channels	56
Conference Center	
Application	50
ConferenceCenter	
Components	318
License Requirements	318
PC Requirements	318
Configuration	
Create New	69
Erase	207
New	68
Off Line	68
Connections	
Grounding	38
Out of Building	39, 158, 186
ContactStore	
Application	51
Components	319
License Requirements	319
PC Requirements	319
Control Unit	
IP406 v2	18, 218
IP412	18, 216
IP500	20, 214
IP500 System Unit	18
Professional Edition	20
Rack Mounting	40
Small Office Edition	225
SOE	18
Standard Edition	20
Summary	19
Wall Mounting	40
Control Units	
SAP Code	367
Core Software	45
Country	
Languages	47
Supported Locales	47
Create Configuration	69
CTI	
SAP Code	367
D	
Daughter Cards	
Analog Trunk	23, 238
BRI Trunk	23, 239
PRI Trunk	240
PRI-U Trunk	23
Trunk	23
DC I/P	
Port	350
DCI I/P Port	356
DECT	
Handset	278, 279
Phone	44, 263
Region Availability	44, 263
Delta Server	
Components	320
License Requirements	320
PC Requirements	320
DevLink Application	53
DS	
IROB	187
Phone	44, 187, 263
Port	350, 356
Region Availability	44, 263
DTE Port	206
Cable requirement	206, 357
RS232	206, 357
Settings	206, 357
Dual PRI	
Trunk Card	24
E	
Embedded Voicemail	
Application	51
Memory Card	31
EMC Cautions	
Canadian Department of Communications	393
EMC Caution for China	393
Federal Communications Commission	393
Envirmental Requirements	64
Equipment Availability	10, 386
Expansion	
Port	350
Expansion Modules	
IP400 Analog Trunk	26
IP400 Analog Trunk	16, 241
IP400 Digital Station	26, 245
IP400 Digital Station V2	243
IP400 Phone	26, 249
IP400 Phone V2	247
IP400 So8	26, 251
IP400 WAN3	26
IP400 WAN3 10/100	253
IP500 Analog Trunk	16, 255
IP500 BRI So8	257
IP500 Digital Station	26, 259
IP500 Phone	26, 261
IPO 500 Analog Trunk	26
IPO 500 BRI So8	26
Expansion Port	358
Exporting Settings	70
EXT O/P	
Port	350
EXT O/P Port	191, 358
Extension Numbers	
Changing	168
Renumbering	168
Swapping	170
External Expansion Modules	26
F	
Faulty Units	10
FCC Rules	391
Feature Key Dongles	
SAP Code	367
Feature Key Server	
Application	49
Components	321
License Requirements	321
PC Requirements	321
Feature Keys	

- Feature Keys
 - Parallel 42, 193
 - Serial 42, 193
 - Smart Card 42, 193
 - USB 42, 193
- Features
 - 2402D Phone 270
 - 2410D Phone 271
 - 2420 Phone 272
 - 3616 Phone 273
 - 3620 Phone 274
 - 3626 Phone 275
 - 3641 Phone 276, 278
 - 3645 Phone 277
 - 3711 Phone 279
 - 3810 Phone 280
 - 4406D+ Phone 281
 - 4412D+ Phone 282
 - 4424D+ Phone 283
 - 4601 Phone 284
 - 4602IP Phone 285
 - 4602SW Phone 285
 - 4610SW Phone 286
 - 4620IP Phone 287
 - 4620SW Phone 287
 - 4621SW Phone 288
 - 4625SW Phone 289
 - 5202D Phone 290
 - 5220D Phone 292
 - 5410 Phone 291
 - 5601 Phone 293
 - 5602IP Phone 294
 - 5602SW Phone 294
 - 5610SW Phone 295
 - 5620 Phone 296
 - 5621 Phone 297
 - 6408D Phone 298
 - 6416D Phone 299
 - 6424D Phone 300
 - T3 Classic 301
 - T3 Comfort 302
 - T3 Compact 303
- Firewall Exceptioning 336
- G**
- General
 - Licenses SAP Code 367
- General Information
 - Training Courses 57
 - Web Sites 58
- Grounding Control Units 38
- H**
- H323
 - Phones 44, 263
 - Region Availability 44, 263
- Handset Accessories
 - SAP Code 367
- Hazard Symbols 389
- Hazardous Substances 10, 386
- Homologation Statement 388
- HP OpenView 200
- I**
- Importing Settings 70
- Installing
 - 2400 Series Phones 159
 - 5400 Series Phones 159
- EU24 Add-on 164
- Internal Cards
 - SAP Code 367
- IP 400 Installation
 - Admin Applications 75, 95
 - Connect Manager PC 79, 99
 - Expansion Modules 111
 - Grounding 115
 - Modem Cards 104
 - Power up Control Unit 97
 - Rack Mounting 109
 - Receive Configuration (Pre 3.2) 80, 100
 - System Status Application 91, 122, 155
 - Trunk Cards 106
 - Unpacking 74, 94
 - Upgrade 117
 - VCM Cards 102
 - WAN 3 113
- IP Dect
 - Base Stations SAP Code 367
 - Handset SAP Code 367
 - Licenses SAP Code 367
 - SAP Code 367
 - Survey Kits SAP Code 367
- IP Office Application CDs
 - SAP Code 367
- IP Office Operation in
 - Australia 394
 - Canada 394
 - China 395
 - European Union 396
 - New Zealand 396
 - USA 396
- IP400
 - External Expansion Modules SAP Code 367
 - Trunk cards 24
 - Trunk cards SAP Code 367
 - Voice Compression Modules card 31
- IP400 Installation
 - Receive Configuration (3.2+) 90, 121
 - Security Settings 89, 120
 - Using Monitor 81, 101
- IP406 v2 14
 - Control Unit 218
- IP412 14
 - Control Unit 216
- IP500
 - Analog Phone Base Card 21
 - Analog Trunk Daughter Card 23
 - Base Cards SAP Code 367
 - BRI Trunk Daughter Card 23
 - Control Unit 214
 - Daughter Cards SAP Code 367
 - Digital Station Base Card 21
 - External Expansion Modules SAP Code 367
 - Legacy Card Carrier Base Card 21
 - PRI-U Trunk Daughter Card 23
 - Reset Button 185
 - SAP Code 367
 - system 16
 - Trunk Daughter Card 23
 - VCM Base Card 21
- IP500 Installation
 - Receive Configuration (3.2+) 90, 121
- IP500 Installation
 - Admin Applications 136

IP500 Installation

- Card 129
- Check Card LED 142
- Check CPU LED 141
- Connect Manager 138
- Documentation 127
- Expansion Modules 145
- Feature Key 133
- Grounding 153
- Licences 144
- Power 134
- Rack Mounting 148
- Receive Config 143
- Security Settings 89, 120, 147
- Start Manager 139
- System Status Application 91, 122, 155
- Tools 126
- Unpacking 128
- Upgrade Software 140
- Using Monitor 81, 101
- Wall Mounting 151

L

LAN

- Port 350

LAN Port 359

Level of Software 45

Licences

- CCC 344
- Compact Contact Center 314
- Conference Center 318
- ContactStore 319
- CTI 345
- Delta Server 320
- Feature Key Server 321
- General 342
- Installation Requirements 194
- IP DECT 348
- IP500 343
- IP500 PRI Trunk Channels 20
- IP500 Upgrade Standard to Professional 20
- IP500 Voice Networking 20
- Manager 322
- Monitor 323
- MS-CRM 324
- Parallel Port Feature Key 196
- Phone Manager 325, 346
- Serial Port Feature Key 195
- SoftConsole 327
- Syatem Status Application 328
- TAPI 329
- Trial Licences 349
- USB Feature Key 196
- VoiceMail 347
- VoiceMail Lite 331
- VoiceMail Pro 332

License Keys

- Enter 43, 192

Licenses

- CCC 367
- CTI 367
- General 367
- IP Dect 367
- IP500 367
- PC-Base 42, 193
- PC-Less 42, 193
- Phone Manager 367
- Trial 367
- VoiceMail 367

Lightening Portection 389

Lightening Protection 39, 186

Lithium Batteries 389

M

Maintenance

- Applications 49

Manager

- Application 49
- Button Programming 166
- Clock Quality 174
- Components 322
- Extension Numbers 168
- License Requirements 322
- PC Requirements 322
- Prefix Dialing 178
- Trunks 176
- Upgrade Software 182

Modem Card 31

Module

- Polycom Video 198

Modules

- Trunk Interface 390

Monitor

- Application 49
- Components 323
- License Requirements 323
- PC Requirements 323
- Protocols 336

Mounting

- SAP Code 367

MS-CRM

- Application 50
- Components 324
- License Requirements 324
- PC Requirements 324

N

Network Assessments 55

New Configuration 68, 69

O

Off Line Configuration 68

Operating Systems 340

Out of Building

- Connections 39, 158, 186

P

Package Damage

- Check 74, 94

Parallel Feature Key 42, 193

PC

- Minimum Specifications 340

PC-Base Licensing 42, 193

PC-Less Licensing 42, 193

PF

- Port 350

PF Port 360

Phone (POT)

- Port 350

Phone (POT) Port 361

Phone 2000 Series

- 2402D 270
- 2410D 271
- 2420 272

Phone 3000 Series

- 3616 273

- Phone 3000 Series
 - 3620 274
 - 3626 275
 - 3641 276
 - 3645 277
 - 3701 278
 - 3711 279
 - 3810 280
 - DECT Handset 278, 279
 - WiFi 273, 274, 275, 276, 277
 - Wireless 280
- Phone 4000 Series
 - 4406D+ 281
 - 4412D+ 282
 - 4424D+ 283
 - 4601 284
 - 4602IP 285
 - 4602SW 285
 - 4610SW 286
 - 4620 287
 - 4620SW 287
 - 4621SW 288
 - 4625SW 289
- Phone 5000 Series
 - 5402D 290
 - 5410 291
 - 5420D 292
 - 5601 293
 - 5602IP 294
 - 5602SW 294
 - 5610SW 295
 - 5620 296
 - 5621 297
- Phone 6000 Series
 - 6408D 298
 - 6416D 299
 - 6424D 300
- Phone Manager
 - Application 50
 - Components 325
 - Licences SAP Code 367
 - License Requirements 325
 - PC Requirements 325
- Phone T3 Series
 - Classic 301
 - Comfort 302
 - Compact 303
- Polycom Video Module 198
- Port
 - Analog 350, 353
 - Assigned 336
 - Audio 350, 353
 - BRI 350
 - BRI (So) 354
 - BRI (Trunk) 355
 - DC I/P 350
 - DCI I/P 356
 - Door 191
 - DS 350, 356
 - Expansion 350, 358
 - EXT O/P 191, 350, 358
 - IP Office 336
 - LAN 350, 359
 - PF 350, 360
 - Phone (POT) 350, 361
 - PRI 350, 362
 - RS232/DTE 350
 - RS323 DTE 206, 357
 - Safety Classification 392
 - USB 350
 - Used 336
 - WAN 350, 363
 - WAN V.24 364
 - WAN V.35 365
 - WAN X.21 366
- Power Cords
 - SAP Code 367
- Power Supplies
 - 1151C1 33
 - 1151C2 33
 - Cords 34
 - Type 40w PSU 33
 - Type 45W Earthed PSU 33
 - Type 60W Earthed PSU 33
 - Uninterrupted Power Supply 35
- Power Supply Units
 - SAP Code 367
- PRI
 - Port 350
- PRI Port 362
- Programmable Buttons 304, 306, 307, 308, 310
- Programming
 - Button 166
- Protocols 336
- Q**
- Quad BRI
 - Trunk Card 24
- R**
- Rack Mounting Control Units 40
- Recorder Interface 309
- Region Availability
 - Analog Phone 44, 263
 - DECT Phone 44, 263
 - DS Phone 44, 263
 - H323 Phone 44, 263
- Renumber Extensions 168
- Requirements
 - Cable Access 62
 - Cable Clearance 62
 - Enviromental 64
 - Parts 65
 - Space 62
 - Tools 65
 - Wall Mounting 64
- RoHS 10, 386
- RS232/DTE
 - Port 350
- S**
- Safety Statement 388
- SAP Codes
 - 201B Recorder 309
 - 2400 Series Phone 367
 - 2402D Phone 270
 - 2410D Phone 271
 - 2420D Phone 272
 - 3600 Serices Phone 367
 - 3616 Phone 273
 - 3620 Phone 274
 - 3626 Phone 275
 - 3641 Phone 278
 - 3700 Series Phone 367

SAP Codes

3711 Phone 279
3810 Phone 280, 367
4406D+ Phone 281
4412D+ Phone 282
4424D+ Phone 283
4450 Programmable Buttons 304
4601 Phone 284
4602IP Phone 285
4602SW Phone 285
4610SW Phone 286
4620IP Phone 287
4620SW Phone 287
4621SW Phone 288
4625SW Phone 289
5400 Series Phone 367
5402D Phone 290
5410 Phone 291
5420D Phone 292
5600 Series Phone 367
5601 Phone 293
5602IP Phone 294
5602SW Phone 294
5610SW Phone 295
5620 Phone 296
5621 Phone 297
6400 Series Phone 367
6408D Phone 298
6416D Phone 299
6424D Phone 300
Barrier Boxes 367
Cables 367
CCC Licenses 367
CTI Licenses 367
EU24 Programmable Buttons 306
EU24BL Programmable Buttons 307
Feature Key Dongles 367
General Licenses 367
Handset Accessorie 367
Internal Cards 367
IP DECT Base Station 367
IP Dect Handset 367
IP Dect Licenses 367
IP Dect Survey Kit 367
IP Office Application CDs 367
IP Office Control Units 367
IP400 External Exapansion Modules 367
IP400 Trunk cards 367
IP500 Base Cards 367
IP500 Daughter Cards 367
IP500 External Expansion Modules 367
IP500 Licenses 367
Mounting 367
Phone Manager Licences 367
Power Cords 367
Power Supply Units 367
Series Phone 367
Spares 367
T3 Classic 301
T3 Comfort 302
T3 Compact 303
T3 DSS Programmable Buttons 308
T3 Series Phone 367
Trial Licenses 367
VoiceMail Licenses 367
XM24 Programmable Buttons 310

Security Settings

Default 209
Serial Feature Key 42, 193
Server
Minimum Specifications 340
Settings
CSV File Formats 70
Exporting 70
Importing 70
Single E1 PRI
Trunk Card 24
Single E1R2
Trunk Card 24
Single PRI T1
Trunk Card 24
Small Office Edition 13
Control Unit 225
Wireless Card 31
Smart card Feature Key 42, 193
SNMP 200
Enabling 203
Installation 201
Port 203
respond 203
Trap Generation 204
Trap Sending 203
SNMP MIBs
Application 49
So8
Example ISDN Terminal 197
Example Video Conference 198
SOE Installation
Admin Applications 75, 95
Connect Manager PC 79, 99
Default Control Unit 77
Fittomg Trunk Cards 82
Grounding 86
Mounting 84
Receive Configuration (Pre 3.2) 80, 100
Recieve Configuration (3.2+) 90, 121
Security Settings 89, 120
System Status Application 91, 122, 155
Unpacking 74, 94
Upgrade Core Software 87
Using Monitor 81, 101
SoftConsole
Application 50
Components 327
License Requirements 327
PC Requirements 327
Software
Erase Core Software 210
Software level 45
Space Requirements 62
Spares
SAP Code 367
Statement
Homologation 388
Safety 388
Supported
Language 47
Locales 47
System Status
Application 49
System Status Application
Components 328

System Status Application
 License Requirements 328
 PC Requirements 328

T

T3
 Series Phone SAP Code 367

TAPI
 Components 329
 License Requirements 329
 PC Requirements 329
 WAV Driver Application 53

TAPILink Lite
 Application 50

TAPILink Pro Application 53

Training Courses 57

Trial Licenses
 SAP Code 367

Trunk Interface Modules 390

U

Unpacking 74, 94

Upgrade Software 45

USB
 Feature Key 42, 193
 Port 350

V

Voice Compression Channels 56

VoiceMail
 SAP Code 367

VoiceMail Lite
 Application 51
 Components 331
 License Requirements 331
 PC Requirements 331

VoiceMail Pro
 Application 51
 Components 332
 License Requirements 332
 PC Requirements 332

VoIP Assessments 55

W

Wall Mounting Control Units 40

Wall Mounting Requirements 64

WAN
 Link 184
 Port 24, 350, 363
 V.24 Port 364
 V.35 Port 365
 X.21 Port 366

Waterproof Phone 274

Web Sites 58

WiFi Phone 273, 274, 275, 276, 277

Wireless Phone 280

Performance figures and data quoted in this document are typical, and must be specifically confirmed in writing by Avaya before they become applicable to any particular order or contract. The company reserves the right to make alterations or amendments to the detailed specifications at its discretion. The publication of information in this document does not imply freedom from patent or other protective rights of Avaya or others.

Intellectual property related to this product (including trademarks) and registered to Lucent Technologies have been transferred or licensed to Avaya.

All trademarks identified by the ® or ™ are registered trademarks or trademarks, respectively, of Avaya Inc. All other trademarks are the property of their respective owners.

This document contains proprietary information of Avaya and is not to be disclosed or used except in accordance with applicable agreements.

Any comments or suggestions regarding this document should be sent to "wgctechpubs@avaya.com".

© 2008 Avaya Inc. All rights reserved.

Avaya
Unit 1, Sterling Court
15 - 21 Mundells
Welwyn Garden City
Hertfordshire
AL7 1LZ
England.

Tel: +44 (0) 1707 392200
Fax: +44 (0) 1707 376933

Web: <http://www.avaya.com/ipoffice/knowledgebase>